



Baseplate Installation Instructions

BX1680

2007-09 Chevy Equinox

Installation Instructions

Serial Number

Please read BOTH these Installation Instructions and the General Towing Instructions before attempting to install or operate this equipment.

1. Blue Ox® towing products and accessories are intended to be installed by Blue Ox® Dealers who are familiar with our products and have the equipment and knowledge to do "fit work." When necessary, Blue Ox® Dealers can be found at www.blueox.com or by contacting our Customer Care Department at (402) 385-3051.

Attachment Tab Height: 15"
Attachment Tab Width: 24"

2. Many Blue Ox® Baseplates are designed to use existing holes and hardware to mount the baseplate to the towed vehicle. Even though bolts are there, do not assume they are adequate for baseplate mounting. Always use hardware supplied in the hardware kit or existing hardware specified in the Baseplate Towing Installation Instructions.

Bolt Torque Specifications

Torque in Foot-Pounds for Metric Bolts

Table with 3 columns: Bolt Size, Grade 8.8, Grade 10.9. Rows include 6MM, 8MM, 10MM, 12MM, 14MM.

Confirm the towability and pre-towing procedures for your vehicle with the owner's manual or contact the vehicle's manufacturer for specific towing procedures.

Bolt Torque Specifications

Torque in Foot-Pounds for Inch Bolts

Table with 3 columns: Bolt Size, Grade 5, Grade 8. Rows include 1/4", 5/16", 3/8", 7/16", 1/2", 5/8".

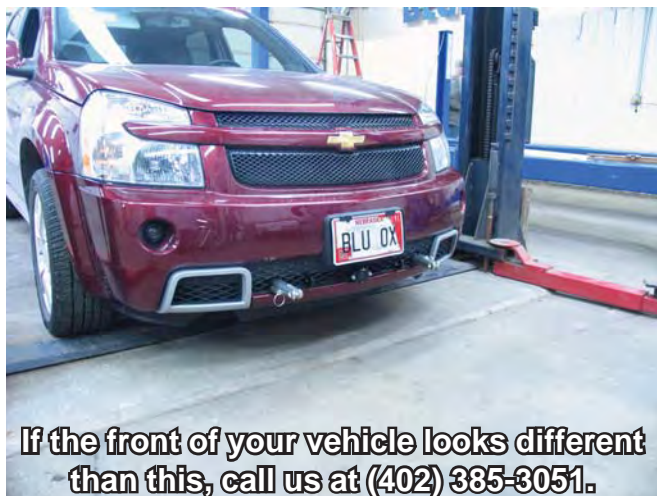

If the front of your vehicle looks different than this, call us at (402) 385-3051.

WARNING

Failure to read and follow these instructions could result in separation of the towed vehicle from the tow bar, causing property damage, loss of towed vehicle, personal injury or death.

BX1680

2007-09 Chevy Equinox

Installation Instructions

Parts List

Ref. No.	Qty.	Part #	Description
1	1	61-6503	WLDM'T, BASEPLATE, BX1680
2	8	61-5208	WLDT, NUT PLT, 1/4X1X1, 3/8 BLT WIR
3	8	201-0444	3/8-16 X 2 HEX BOLT GRADE 5 ZP.
4	8	203-0010	3/8 LOCK WASHER, ZP
5	2	201-0553	1/4-20 X 1/2 HX.WSHD.TYPE F TCS, ZP
6	2	201-0192	10-32 X 1/2 SLOT, RD. HD. SCREW
7	2	203-0054	#10 LOCK WASHER
8	2	202-0047	#10-32 HEX NUT
9	2	101-5822	ADAPTER, 4 WAY CONNECTOR
10	2	62-3469	ATT TAB ASSY, REM, SF/LB, 1 HOLE
	2	226-0046	BASEPLATE SAFETY CABLE, 36" CL III (Not Shown)
	2	229-0359	QUICKLINK, 3/8, ZP (Not Shown)
	2	290-0437	RECEIVER, CAP PLUG (BLK) (Not Shown)

Tools Required

Flat Screwdriver	9/16" Socket
13/32" Drill Bit	7MM Socket
Reciprocating Saw	10MM Socket
Utility Knife	Large Vise Grip
Loctite® RED	

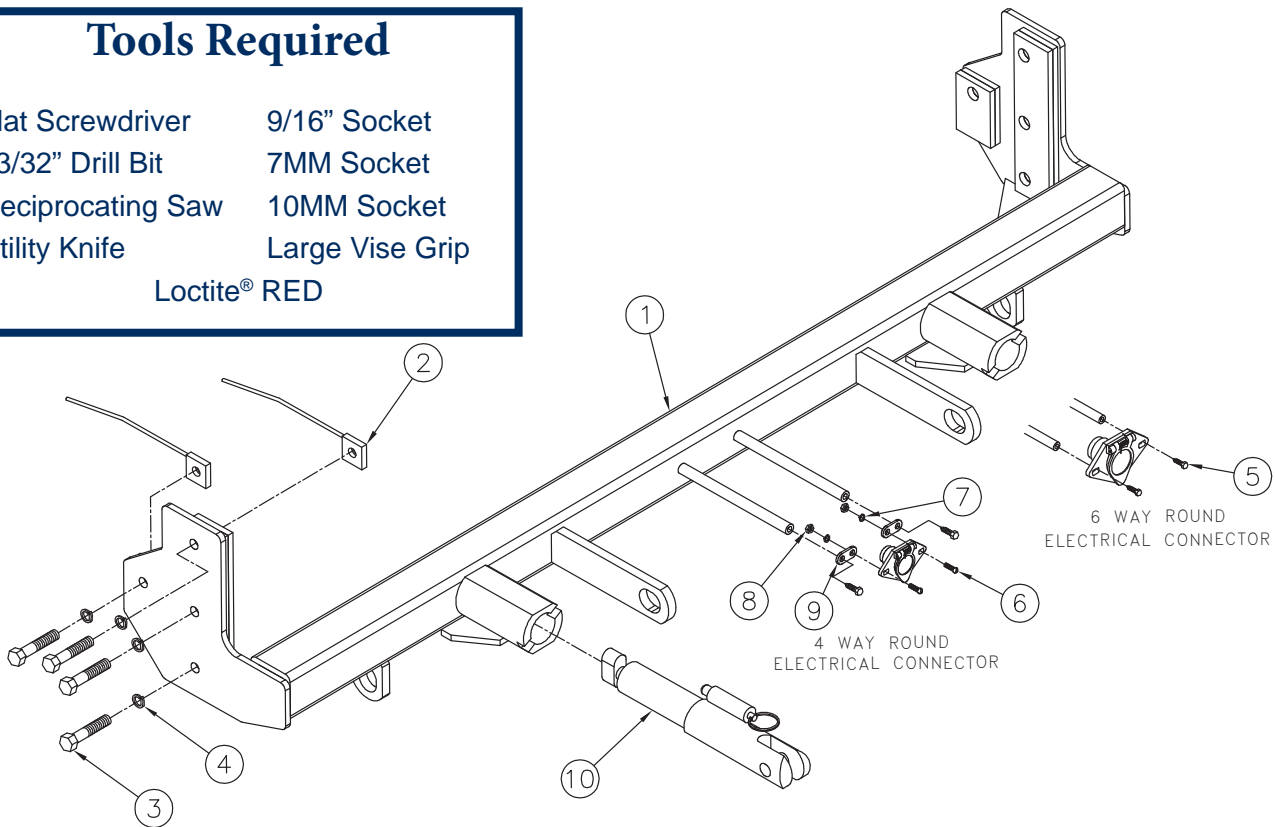

Important:

Use only genuine factory replacement parts on your baseplate. Do **NOT** substitute homemade or non-typical parts. If a bolt is lost or in need of replacement, for your safety and the preservation of your baseplate, be sure to use a replacement bolt of the same grade (In most cases it will be Grade 5, please reference the parts list above). Replacement parts may be ordered through your nearest Blue Ox® Dealer or Distributor. Failing to follow and/or altering these installation instructions in either installation or required equipment will void the manufacturer's warranty. Towing behind a non-motorized vehicle will void the

BX1680

2007-09 Chevy Equinox

Installation Instructions

Vehicle Weight:

Due to the design of the removable tabs, the RangeFinderII tow bar can not be used. Adapters, except the BX8833 and BX88151, can not be used with this baseplate.

Installation Notes: The fascia, bolts and push pins are removed and reinstalled during installation of the baseplate. Drilling is required. Trimming is required.

The dimensional variations between otherwise identical vehicles can be considerable. While the baseplate was designed for easy installation, it may be necessary to tailor the baseplate slightly to compensate for auto manufacturer's tolerances. These minor adjustments may include filing a hole slightly, bending electrical rods or bending end plates.

The BX8869 Bulb & Socket Wiring Kit is recommended for this vehicle.



Installation Instructions:

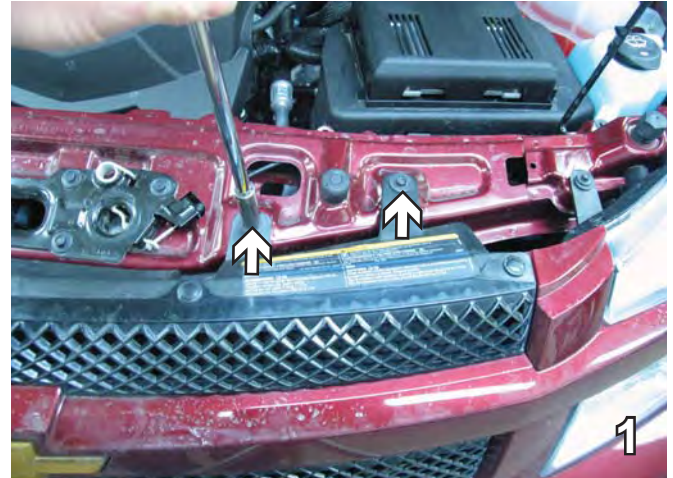

1. Using a 10MM socket, remove four bolts from the flat plastic piece on top. Do this to both sides, two on each side, of the vehicle. Set bolts aside to be reinstalled later.

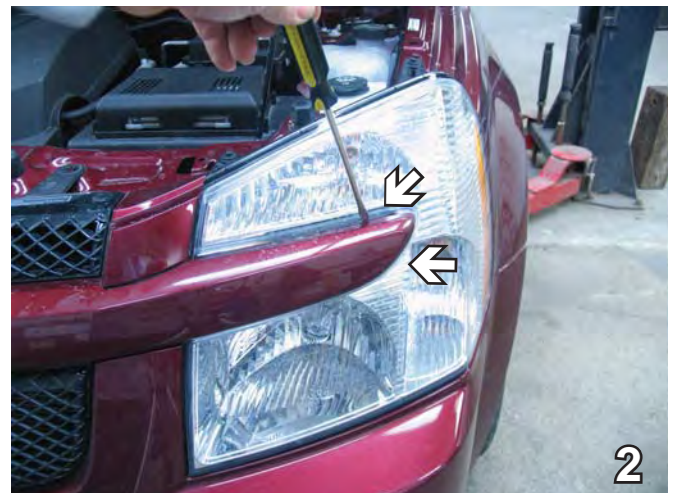

2. Insert a flat screw driver, and pop out the corner of the fascia over the headlight. Do this on both sides.

Handling of some cosmetic parts when installing this product may require the use of protective covers, rags, specialty tools, etc. to prevent damage.

BX1680
2007-09 Chevy Equinox
Installation Instructions



3. Using a 7MM socket, remove bolt just forward of the front tire on the wheel well. Do this to both sides of the vehicle. Set bolts aside to be reinstalled later.

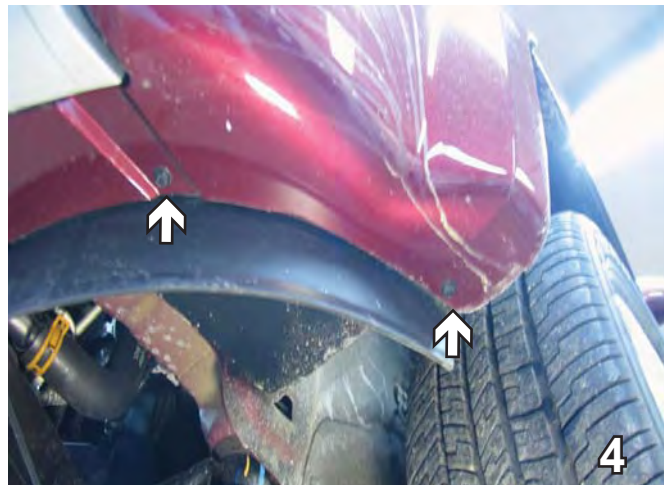

4. Using a 7MM socket, remove two bolts from the lower edge of fascia all the way around. Do this to both sides of the vehicle. Set bolts aside to be reinstalled later.

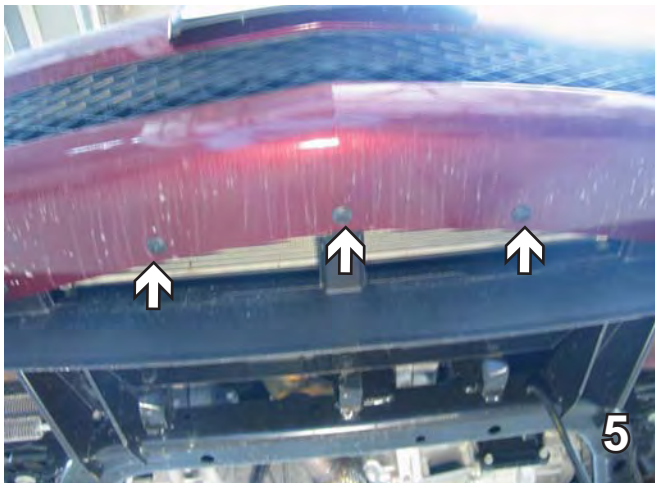

5. Using a flat screw driver, remove five push pins from the lower edge of fascia all the way around. Set push pins aside to be reinstalled later.



6. The fascia is then ready to be removed from the vehicle. Lift the corners of the fascia above the three little knobs holding the edge (white arrows). Do this on both sides. Squeeze the two push pins (gray arrows) in order to remove the fascia. Do this on both sides. Then set fascia aside carefully to be reinstalled later.

BX1680
2007-09 Chevy Equinox
Installation Instructions

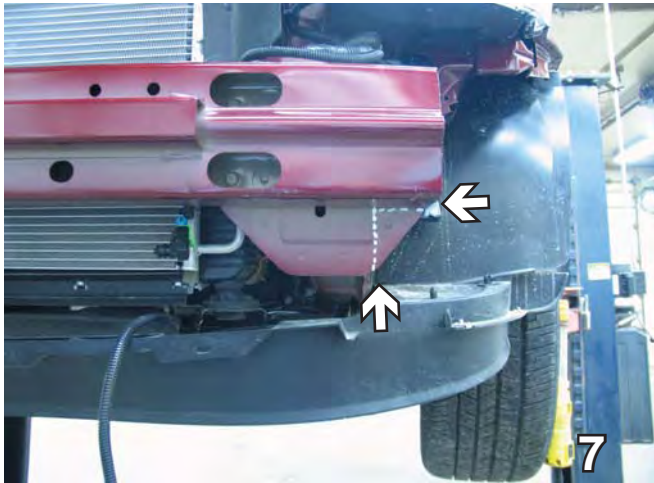

7. Using a reciprocating saw, trim under the bumper, as indicated in the photo. Do this to both sides.



8. Using a reciprocating saw, trim away plastic area, 1" across and up, located on the back side of the fascia.

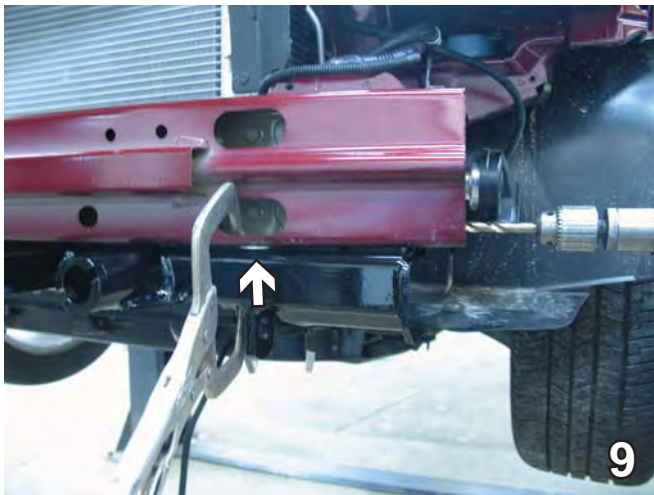

9. Place a 1/2" flat washer as a spacer between the baseplate and the bumper. Using the large vise grip, clamp the baseplate into place with the frame.

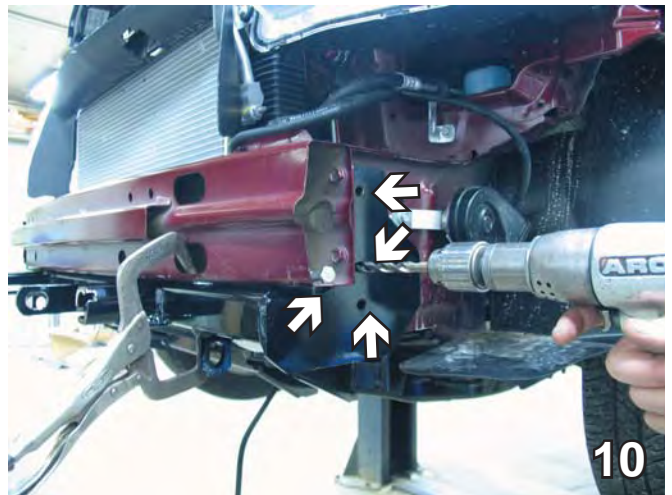

10. Using the baseplate as a template, with the 13/32" drill bit, drill all four holes on each side. Do this to both sides of the vehicle. Insert 3/8-16 x 2" hex bolts, 3/8" lock washers with Loctite Red. Attach to 1/4 x 1 x 1" nut plates inserted into the frame and tighten. Do this to both sides of the vehicle.

When using power drills be aware of the dangers of torque and drill bit length.

11. Install the baseplate safety cables to frame of vehicle. If vehicle has additional options which interfere with mounting permanent baseplate safety cables, secure the cables to a solid piece of the vehicle frame as described in instructions included with the permanent baseplate safety cables. Be sure the cables do not rub against any hoses or moving parts.

BE SURE TO USE LOCTITE® RED ON ALL BOLTS BEFORE TIGHTENING. TIGHTEN ALL BOLTS ACCORDING TO THE TORQUE CHART ON THE FRONT PAGE OF THESE INSTRUCTIONS OR ON PAGE 3 OF THE BASEPLATE TOWING GENERAL INSTRUCTIONS.

12. Reinstall front fascia.

BX1680

2007-09 Chevy Equinox

Installation Instructions

Install the tow bar and safety cables according to the instructions provided in their packages. When demonstrating this to the customer, be sure to include all the contents and packages.

Do **NOT** substitute other devices if the tow bar pins and clips are misplaced.

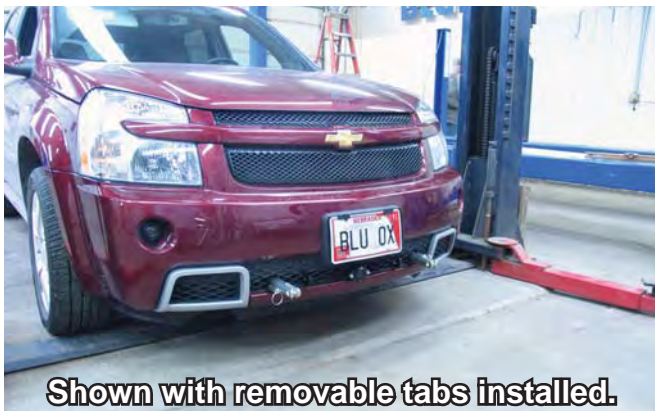
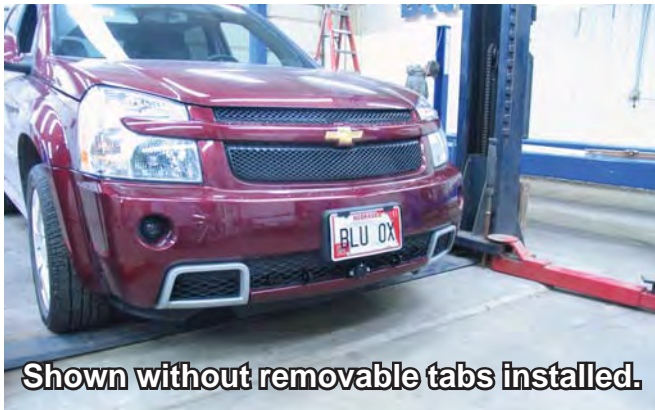

If the baseplate is in an accident, it must be replaced. **DO NOT** use it again! An accident can cause unseen damage and using it again could result in more damage or serious injury. **DO NOT** use the baseplate if it is damaged or missing parts.

Be sure that **ALL** electrical connections are plugged in properly and functioning **BEFORE** installing the fascia.

DEALER or INSTALLER:
Be certain the user receives the instruction sheets for their products.

CUSTOMER SERVICE COMMITMENT

Blue Ox is committed to providing you with exceptional customer care throughout your lifetime with our products. Our team is here to assist you with any questions you may have regarding the performance of your product. Simply call (402) 385-3051 and you can speak with our customer care team.

Additionally, please visit our website to see which rallies our Destination America team will be attending. For a nominal fee, our service technician will service your towing system to ensure it's in proper working condition. Also as a commitment to our customers, should you visit our factory you can stay at our full service Blue Ox campground at no charge along with enjoying a factory tour.

Again thank you for being our customer and for the confidence you have shown in the performance of our products. It is because of customers like you we enjoy the success we have today.



© 2008, 09, 10 Blue Ox
One Mill Road, Industrial Park
Pender, Nebraska 68047
Phone: (402) 385-3051 • Fax: (402) 385-3360
www.blueox.com