



BX1683

2009-12 Chevy Traverse Installation Instructions

Please read **BOTH** these Installation Instructions and the General Towing Instructions before attempting to install or operate this equipment.

Serial Number

1. Blue Ox® towing products and accessories are intended to be installed by Blue Ox® Dealers who are familiar with our products and have the equipment and knowledge to do “fit work”. When necessary, Blue Ox® Dealers can be found at www.blueox.com or by contacting our Customer Care Department at (402) 385-3051.
2. Many Blue Ox® Baseplates are designed to use existing holes and hardware to mount the baseplate to the towed vehicle. Even though bolts are there, do not assume they are adequate for baseplate mounting. Always use hardware supplied in the hardware kit or existing hardware specified in the Baseplate Installation Instructions.

Attachment Tab Height: 16”

Attachment Tab Width: 20”

Bolt Torque Specifications

Torque in Foot-Pounds for Metric Bolts

Bolt Size	Grade 8.8	Grade 10.9
6MM	6	8
8MM	16	22
10MM	31	40
12MM	54	70
14MM	89	117

Confirm the towability and pre-towing procedures for your vehicle with the owner’s manual or contact the vehicle’s manufacturer for specific towing procedures.

Bolt Torque Specifications

Torque in Foot-Pounds for Inch Bolts

Bolt Size	Grade 5	Grade 8
1/4”	10	14
5/16”	19	29
3/8”	33	47
7/16”	54	78
1/2”	78	119
5/8”	154	230



If the front of your vehicle looks different than this, call us at (402) 385-3051.

WARNING

Failure to read and follow these instructions could result in separation of the towed vehicle from the tow bar, causing property damage, loss of towed vehicle, personal injury or death.

BX1683

2009-12 Chevy Traverse Installation Instructions

Parts List

Ref. No.	Qty.	Part #	Description
1	1	61-6614	BX1683 Baseplate
2	4	61-5208	1/4" x 1" x 1", 3/8" with 14" Wire
3	4	201-0443	3/8"-16 x 1" Hex Head Bolt, Grade 5
4	4	201-0440	3/8"-16 x 1-1/2" Hex Head Bolt, Grade 5
5	8	203-0010	3/8" Lock Washer
6	4	202-0003	3/8"-16 Hex Nut, ZP
7	2	201-0553	1/4"-20 x 1/2" Hex Wshd.Type F TCS, ZP
8	2	201-0192	10-32 x 1/2" Slotted Round Head Screw
9	2	203-0054	#10 Lock Washer
10	2	202-0047	#10-32 Hex Nut
11	2	101-5822	4 Way Connector Adapter
12	2	62-3469	Attachment Tab with Hole
Not shown	18	203-0001	1/4 Flat Washer, ZP
Not shown	2	226-0046	36" Class III Safety Cable
Not shown	2	229-0359	3/8" Quicklink
Not shown	2	290-0437	Black Receiver Cap Plug

Tools Required

7MM Socket	Phillips Screw Driver
10mm Socket	Utility Knife
9/16" Socket & Wrench	Tape Measure
Large Vise Grips	1" Hole Saw
Reciprocating Saw	13/32" Drill Bit
Drill	1/2" Drill Bit
Flat Screw Driver	T15 Torx
Loctite® RED	

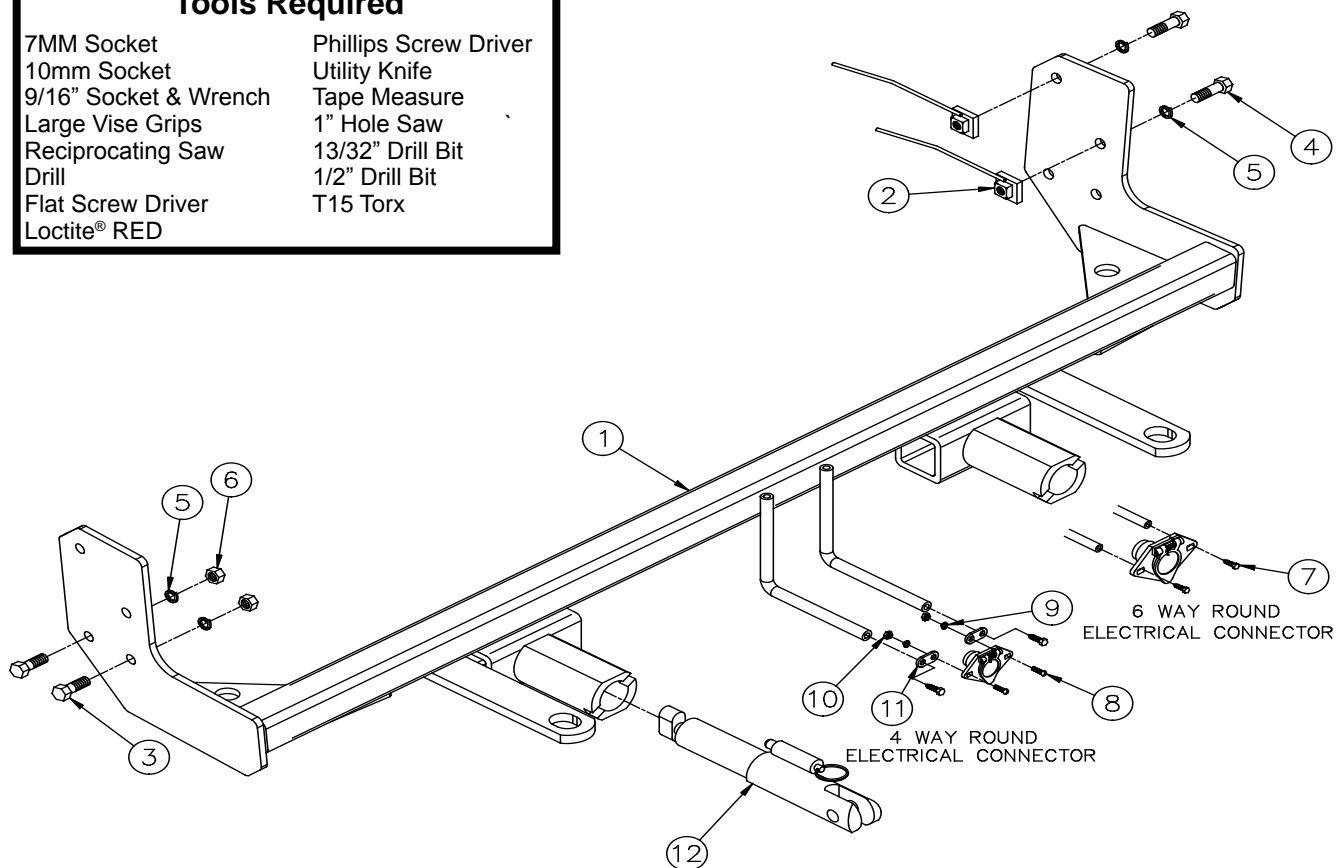

Important:

Use only genuine factory replacement parts on your baseplate. Do **NOT** substitute homemade or non-typical parts. If a bolt is lost or in need of replacement, for your safety and the preservation of your baseplate, be sure to use a replacement bolt of the same grade (In most cases it will be Grade 5, please reference the parts list above). Replacement parts may be ordered through your nearest Blue Ox® Dealer or Distributor. Failing to follow and/or altering these installation instructions in either installation or required equipment will void the manufacturer's warranty. Towing behind a non-motorized vehicle will void the warranty.

BX1683 2009-12 Chevy Traverse Installation Instructions

Attachment Tabs: Motorhome mount tow bars are recommended for use with this baseplate. Due to the design of the removable tabs, the RangeFinderII, Adventurer, and Ambassador tow bars can not be used. The Acclaim tow bar may be used, but will not fold and store on the front of the vehicle. Adapters, except the BX8833 and BX88151, can not be used with this baseplate.

Installation Notes: The fascia, horn and windshield fluid reservoir are removed for installation. The air dam and fascia are trimmed. Drilling is required.

The dimensional variations between otherwise identical vehicles can be considerable. While the baseplate was designed for easy installation, it may be necessary to tailor the baseplate slightly to compensate for auto manufacturer's tolerances. These minor adjustments may include filing a hole slightly, bending electrical rods or bending end plates.

The BX8869 Bulb and Socket Wiring Kit is recommended for this vehicle.



Possible location for the Bulb and Socket Wiring Kit (BX8869).

Handling of some cosmetic parts when installing this product may require the use of protective covers, rags, specialty tools, etc. to prevent damage.

Do not use the towed vehicle for storing luggage, equipment, etc. This may cause you to exceed the towing capacity of the tow bar, baseplate, and its accessories.

Installation Instructions

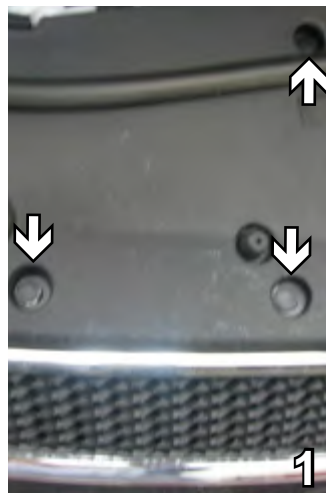

1. Remove five (5) push pins from the plastic piece covering the top of the under carriage with a flat screwdriver. Do this to both sides and set push pins aside for later reinstallation.
2. Remove a christmas tree underneath the rubber. Do this to both sides and set the rubber and the plastic cover aside for reinstallation later.

BX1683
2009-12 Chevy Traverse
Installation Instructions

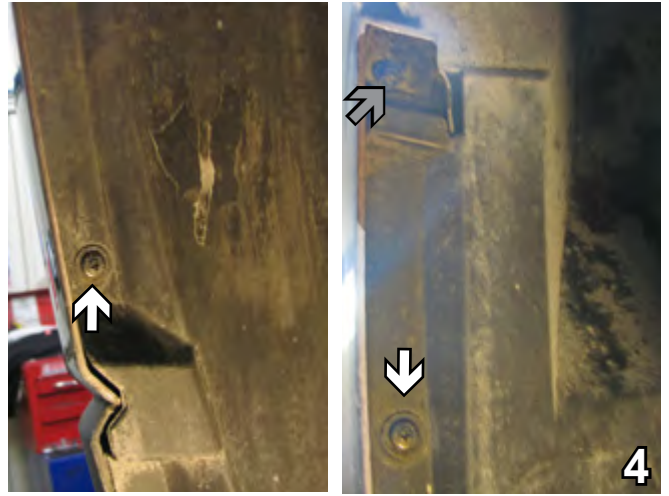
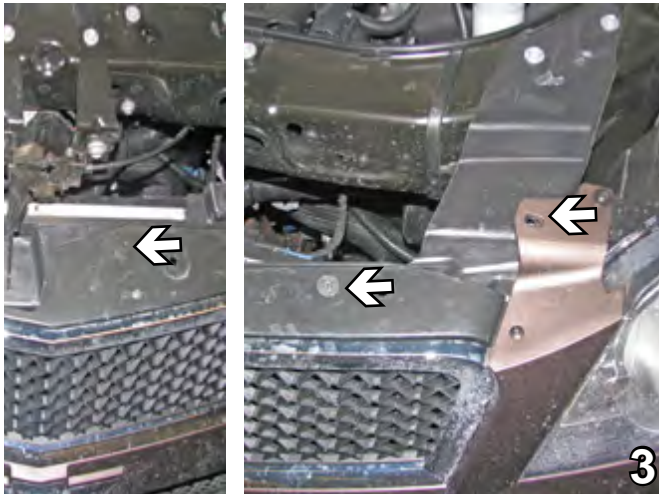

3. Using a 7MM socket (may possibly require T15 Torx), remove three (3) bolts connecting the fascia across the top. Do this to both sides of the vehicle. Set bolts aside to be reinstalled later.
4. Remove two (2) screws (white arrows) just forward of the front tire, on the edge of the fascia with a Phillips screwdriver. Using a 7MM socket (may possibly require T15 Torx), also remove the hex bolt from the top (gray arrow). Do this to both sides. Set screws and bolts aside for later reinstallation.

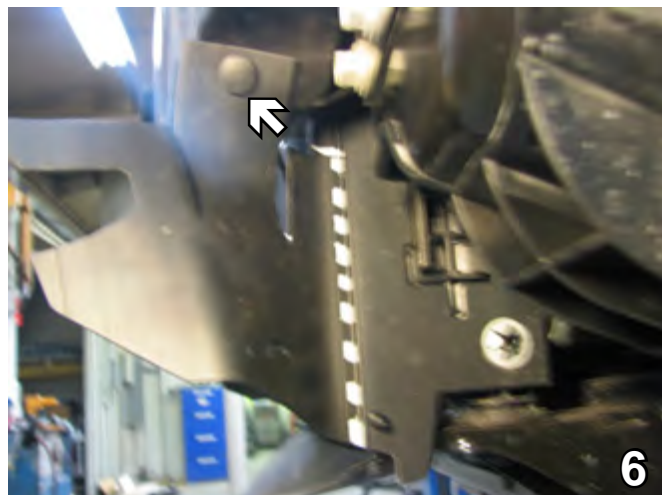
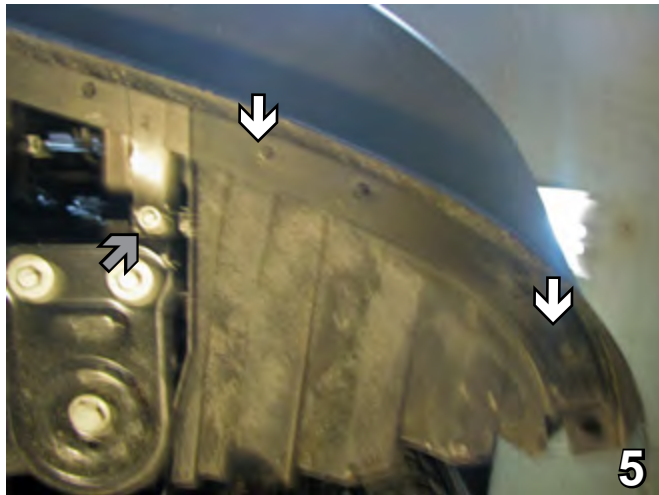

5. Remove two (2) screws (white arrows) from under the fascia with a screwdriver. Using a 10MM socket (may possibly require T15 Torx), also remove the hex bolt (gray arrow) from under the fascia. Do this to both sides. Pull fascia corners to the side of vehicle to release, then pull fascia forward and set fascia aside carefully for later reinstallation along with bolts and screws.
6. Under the front bumper, remove the push pin from the plastic piece then cut straight across and straight down. Do this to both sides.

BX1683
2009-12 Chevy Traverse
Installation Instructions

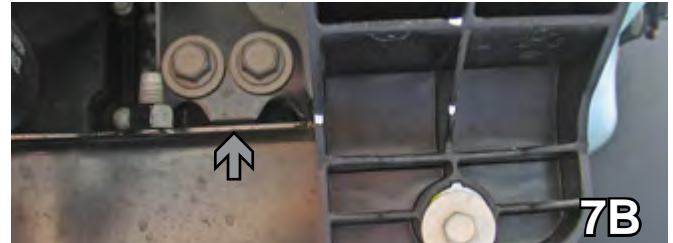
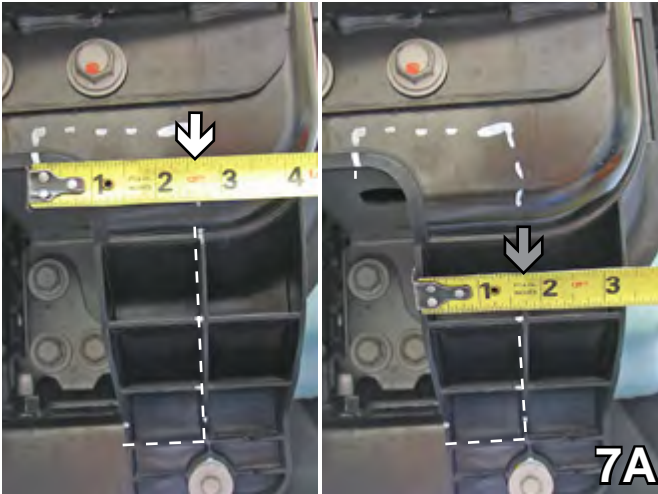

7. Mark 2-1/2" across the top of the frame rail front from middle rib just below bumper and 1-5/8" across bottom; cut and remove with a reciprocating saw (white arrow). When cutting across 1-5/8", make it flush with the middle rib and the bottom of the frame rail (gray arrow). Do this to both sides.

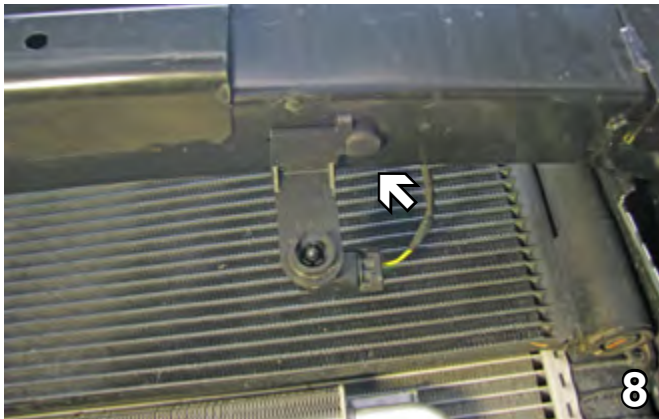

8. On the driver's side, remove the push pin from holding the air temperature sensor. Set aside it will be reinstalled in another location later.

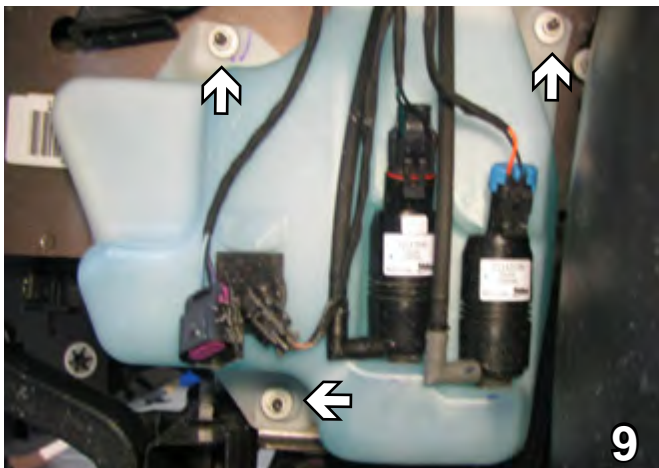

9. On the driver's side using a 10MM socket, remove three (3) hex bolts holding the windshield fluid reservoir. Disconnect fluid and electrical lines and plug the fluid openings. Set aside bolts and reservoir until later reinstallation.
10. Using a 10MM socket, remove the hex bolt holding the horn to the frame rail. Remove the horn and bolt and set aside for later reinstallation. Do this to both sides.

BX1683
2009-12 Chevy Traverse
Installation Instructions

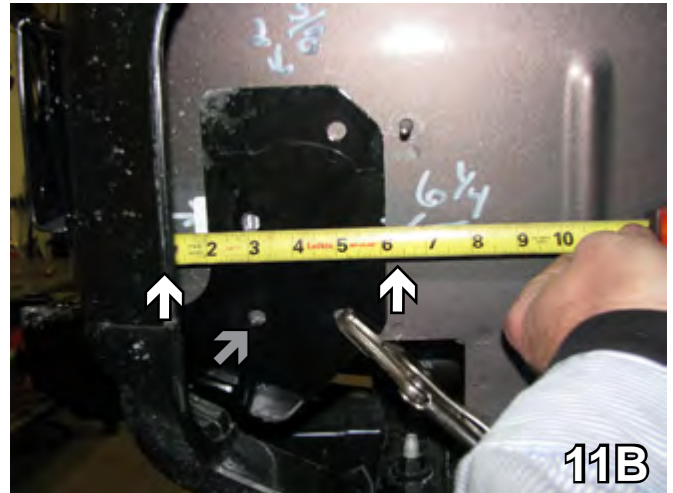
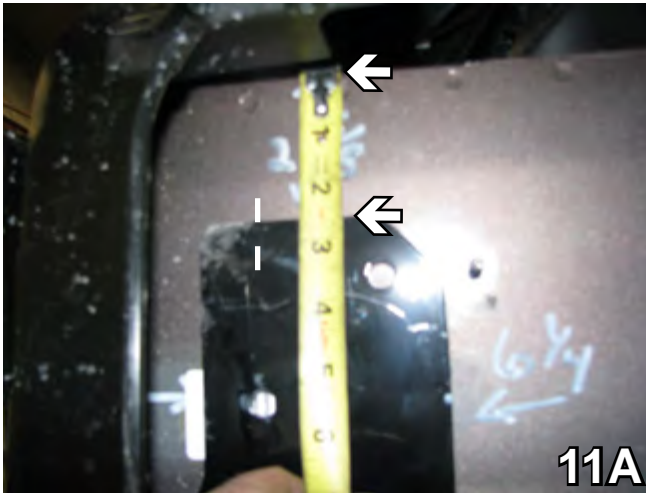

11. Slide the baseplate on the outside of the frame. From the top of the frame down to the baseplate should be 2-5/8" (photo 11A). From the front of the frame to the back of the baseplate should be 6-1/4" (photo 11B). Be sure the baseplate is level. Clamp the baseplate to the frame rail. Using the baseplate as a template with a 13/32" drill bit, drill one (1) hole (gray arrow) on each side. Insert 3/8"-16 x 1" hex bolt with 3/8" lock washer and 3/8"-16 hex nut. Use Loctite Red® on all bolts. Do this to both sides.

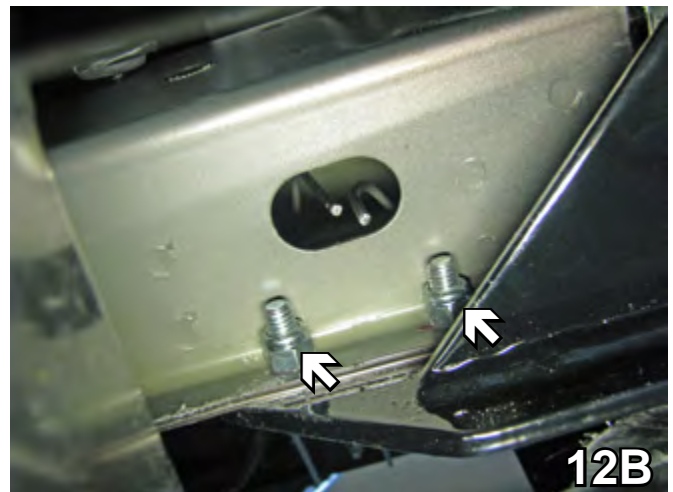
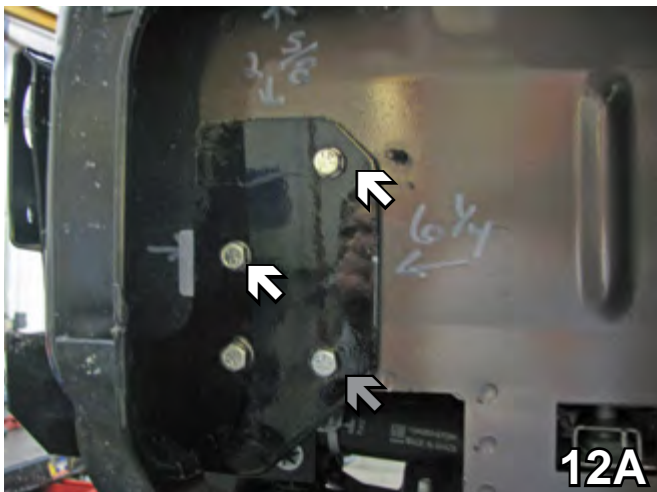

12. Continuing to use the baseplate as a template with a 13/32" drill bit, drill the remaining three (3) holes on each side. Insert another 3/8"-16 x 1" hex bolt with 3/8" lock washer and 3/8"-16 hex nut in the other bottom hole (gray arrow). In the top two (2) holes (white arrows), put 3/8"-16 x 1-1/2" hex bolts with 3/8" lock washers attached to 3/8"-16 nut plates inserted up inside the frame (photo 12B). Use Loctite Red® on all bolts. Do this to both sides.

When using power drills be aware of the dangers of torque and drill bit length.

BE SURE TO USE LOCTITE® RED ON ALL BOLTS BEFORE TIGHTENING. TIGHTEN ALL BOLTS ACCORDING TO THE TORQUE CHART ON THE FRONT PAGE OF THESE INSTRUCTIONS OR ON PAGE 3 OF THE BASEPLATE TOWING GENERAL INSTRUCTIONS.

BX1683
2009-12 Chevy Traverse
Installation Instructions

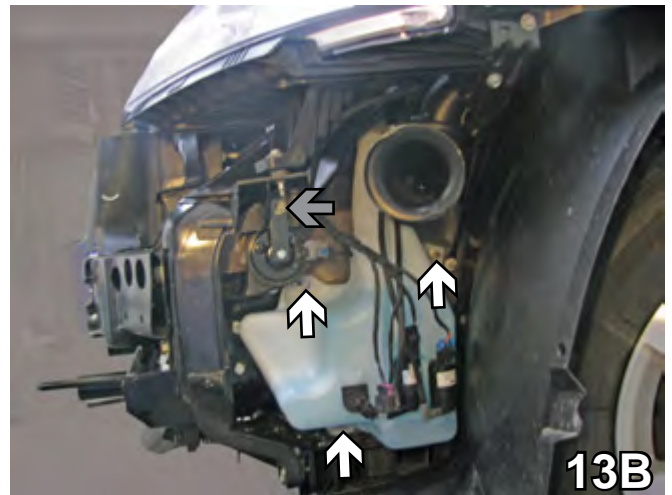
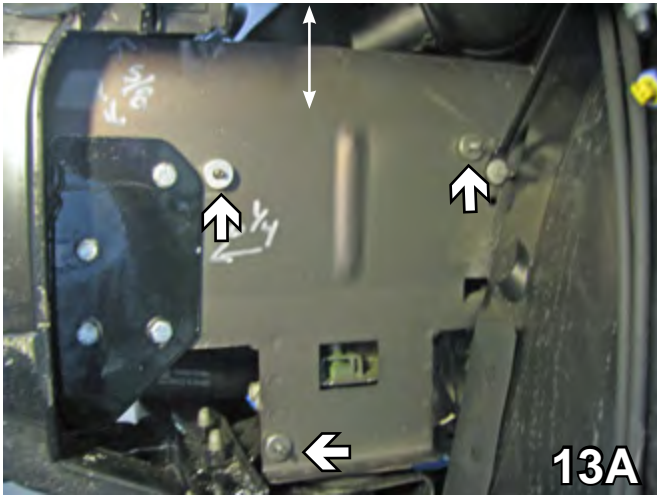

13. Place six (6) 1/4" flat washers on each bolt behind the windshield fluid reservoir to move it out. Reattach the reservoir and reconnect all the electrical and fluid lines. Also reinstall horns one (1) on each side with the existing bolts (gray arrow).

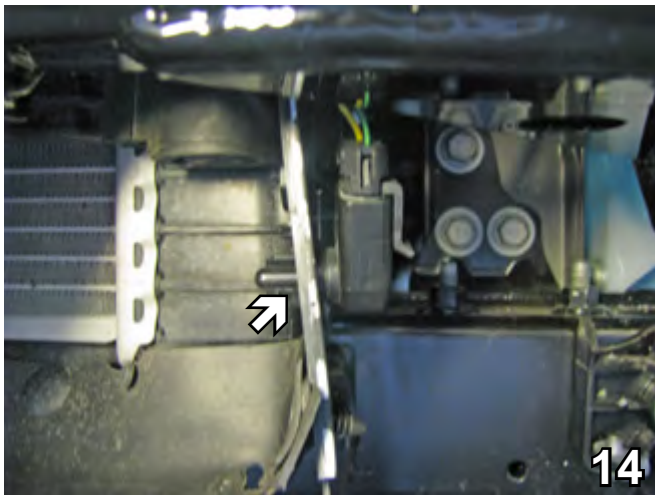

14. On the driver's side, use a 1/2" drill bit to drill a hole in the plastic. Then snap the temperature control in.



15. Attach the permanent baseplate safety cables to the provided convenience link on the baseplate (see grey arrow). The photo above shows the recommended installation of the cables to frame of vehicle (see white arrow). Additional options may interfere with suggested mounting; in this case secure the cables to a solid piece of the frame as described in the instructions included with the permanent baseplate safety cables. Be sure the safety cables do not rub against any hoses or moving parts. Do this to both sides of the vehicle.



16. Hold fascia as close to its original position as possible and trim affected areas so receiver for attachment tab comes through lower grill. Reinstall fascia, push pins and bolts.

BX1683
2009-12 Chevy Traverse
Installation Instructions

Install the tow bar and safety cables according to the instructions provided in their packages. When demonstrating this to the customer, be sure to include all the contents and packages.

Do **NOT** substitute other devices if the tow bar pins and clips are misplaced.

DEALER or INSTALLER:
Be certain the user receives the instruction sheets for their products.

Be sure that **ALL** electrical connections are plugged in properly and functioning **BEFORE** installing the fascia.



Shown without removable tabs installed.



Shown with removable tabs installed.

Customer Service Commitment

Blue Ox is committed to providing you with exceptional customer care throughout your lifetime with our products. Our team is here to assist you with any questions you may have regarding the performance of your product. Simply call (402) 385-3051 and you can speak with our customer care team.

Additionally, please visit our website to see which rallies our Destination America team will be attending. For a nominal fee, our service technician will service your towing system to ensure it's in proper working condition. Also, as a commitment to our customers, should you visit our factory, you can stay at our full service Blue Ox campground at no charge along with enjoying a factory tour.

Again, thank you for being our customer and for the confidence you have shown in the performance of our products. It is because of customers like you we enjoy the success we have today.

If the baseplate is in an accident, it must be replaced. DO NOT use it again! An accident can cause unseen damage and using it again could result in more damage or serious injury. DO NOT use the baseplate if it is damaged or missing parts.



© 2011 Blue Ox
One Mill Road, Industrial Park
Pender, Nebraska 68047
Phone: (402) 385-3051 • Fax: (402) 385-3360
www.blueox.com