



Baseplate Installation Instructions

BX1688 2009-11 Chevy Aveo Includes Foglights Installation Instructions

Serial Number

Please read BOTH these Installation Instructions and the General Towing Instructions before attempting to install or operate this equipment.

- Blue Ox® towing products and accessories are intended to be installed by Blue Ox® Dealers who are familiar with our products and have the equipment and knowledge to do “fit work.” When necessary, Blue Ox® Dealers can be found at www.blueox.com or by contacting our Customer Care Department at (402) 385-3051.
- Many Blue Ox® Baseplates are designed to use existing holes and hardware to mount the baseplate to the towed vehicle. Even though bolts are there, do not assume they are adequate for baseplate mounting. Always use hardware supplied in the hardware kit or existing hardware specified in the Baseplate Towing Installation Instructions.

Attachment Tab Height: 14”

Attachment Tab Width: 17 5/8”

Bolt Torque Specifications
Torque in Foot-Pounds for Metric Bolts

Bolt Size	Grade 8.8	Grade 10.9
6MM	6	8
8MM	16	22
10MM	31	40
12MM	54	70
14MM	89	117

Confirm the towability and pre-towing procedures for your vehicle with the owner’s manual or contact the vehicle’s manufacturer for specific towing procedures.

Bolt Torque Specifications
Torque in Foot-Pounds for Inch Bolts

Bolt Size	Grade 5	Grade 8
1/4”	10	14
5/16”	19	29
3/8”	33	47
7/16”	54	78
1/2”	78	119
5/8”	154	230



If the front of your vehicle looks different than this, call us at (402) 385-3051.

! WARNING

Failure to read and follow these instructions could result in separation of the towed vehicle from the tow bar, causing property damage, loss of towed vehicle, personal injury or death.

BX1688

2009-11 Chevy Aveo (Includes Foglights)

Installation Instructions

Parts List

Ref. No.	Qty.	Part #	Description
1	1	61-6665	WLDM'T, BP, BX1688
2	4	107-3117	SPACER TUBE, 3/4 OD X .406 ID X 1/2"
3	2	107-1753	SPACER TUBE, 3/4 OD X .406 ID X 3/4"
4	6	61-5208	WLD, NUT PLT, 1/4X1X1, 3/8" WITH 14" WIRE
5	4	201-0368	3/8-16 X 1 1/4 HEX HEAD BOLT, GRADE 5
6	4	201-0444	3/8-16 X 2 HEX BOLT, GRADE 5, ZP
7	2	201-0440	3/8-16 X 1 1/2 HEX BOLT, GRADE 5, ZP
8	10	203-0010	3/8 LOCK WASHER, ZP
9	4	202-0090	3/8-16 HEX NYL. INS. LOCK NUT, ZP
10	1	201-0448	1/4-20 X 1 1/2 HEX BOLT, GRADE 5, ZP
11	1	203-0001	1/4 FLAT WASHER, ZP
12	1	203-0008	1/4 LOCK WASHER, ZP
13	1	202-0001	1/4-20 HEX NUT
14	2	201-0553	1/4-20 X 1/2 HX.WSHD.TYPE F TCS, ZP
15	2	201-0192	10-32 X 1/2 SLOT, ROUND HEAD SCREW
16	2	203-0054	#10 LOCK WASHER
17	2	202-0047	#10-32 HEX NUT
18	2	101-5822	ADAPTER, 4 WAY CONNECTOR
19	2	62-3468	ATT TAB ASSY, REM, SF/SB, 1 HOLE
	2	226-0046	BASEPLATE SAFETY CABLE, 36" CL III (Not Shown)
	2	229-0359	QUICKLINK, 3/8, ZP (Not Shown)
	2	290-0437	RECEIVER, CAP PLUG (BLK) (Not Shown)

Tools Required

7MM Socket
 10MM Socket
 9/16" Socket/Wrench
 Large Vise Grip
 Reciprocating Saw
 Drill
 Flat Screwdriver
 Phillips Screwdriver
 1 1/4" Hole Saw
 13/32" Drill Bit
 Loctite® RED

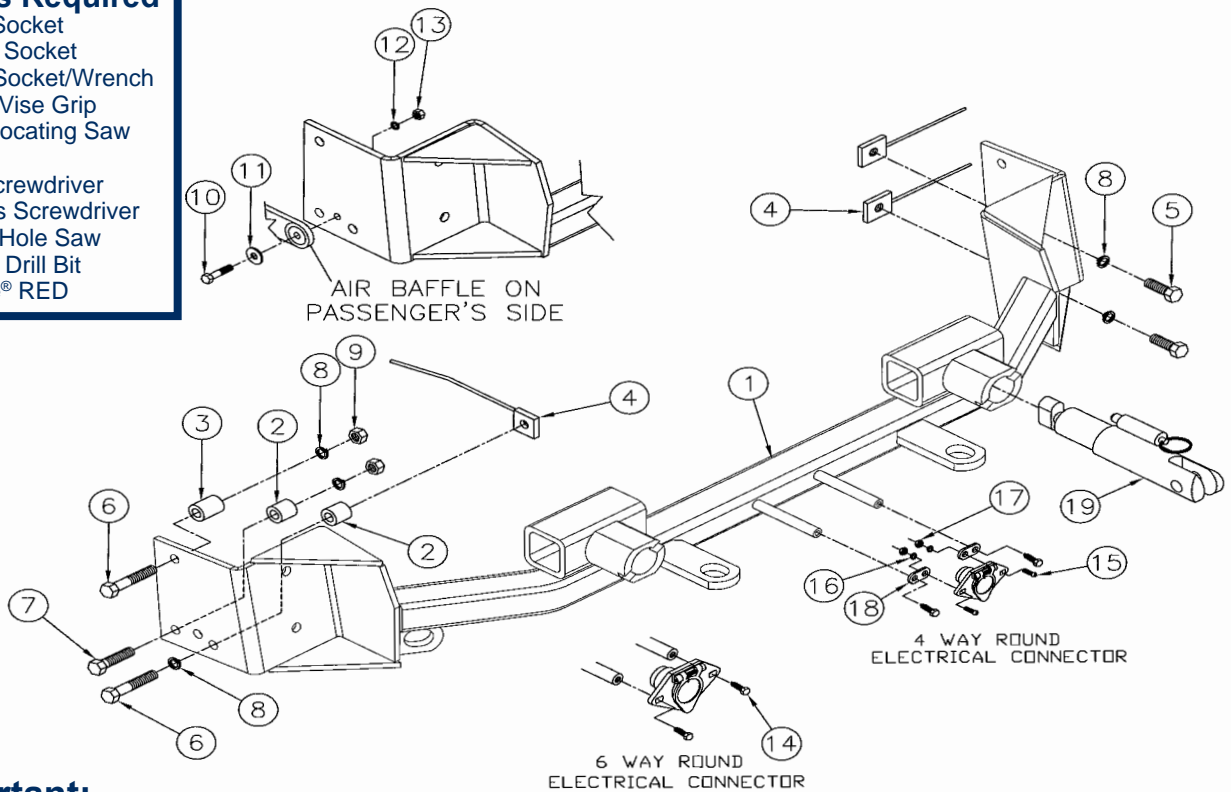

Important:

Use only genuine factory replacement parts on your baseplate. Do **NOT** substitute homemade or non-typical parts. If a bolt is lost or in need of replacement, for your safety and the preservation of your baseplate, be sure to use a replacement bolt of the same grade (In most cases it will be Grade 5, please reference the parts list above). Replacement parts may be ordered through your nearest Blue Ox® Dealer or Distributor. Failing to follow and/or altering these installation instructions in either installation or required equipment will void the manufacturer's warranty.

BX1688

2009-11 Chevy Aveo (Including Foglights)

Installation Instructions

Vehicle Weight: Motorhome mount tow bars are recommended for use with this baseplate. Due to the design of the removable tabs, the RangeFinderII and Ambassador tow bars can not be used. Adapters, except the BX8833 and BX88151, can not be used with this baseplate.

Installation Notes: The grille, headlight assembly, fascia and air baffle are removed and reinstalled during installation of the baseplate. Drilling is required. Trimming is required.

The dimensional variations between otherwise identical vehicles can be considerable. While the baseplate was designed for easy installation, it may be necessary to tailor the baseplate slightly to compensate for auto manufacturer's tolerances. These minor adjustments may include filing a hole slightly, bending electrical rods or bending end plates.

The BX8869 Bulb & Socket Wiring Kit is recommended for this vehicle.



Possible location of the Bulb and Socket Wiring Kit (BX8869)

Installation Instructions:

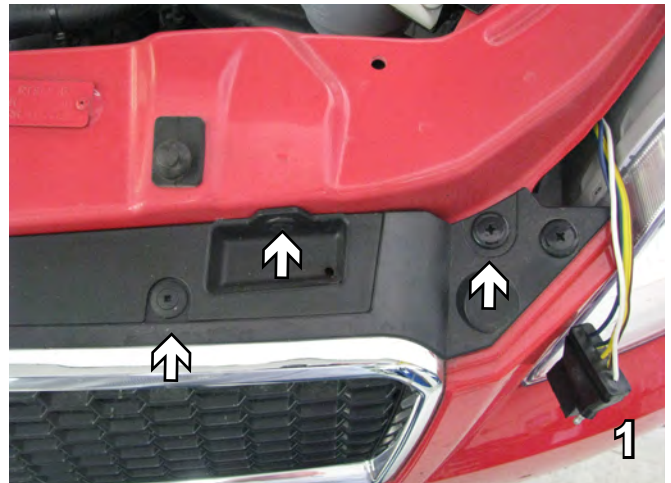

1. Remove three plastic push pins from black plastic grille cover on top side of fascia. Do this to both sides of the vehicle. Set the pins aside to be reinstalled later.

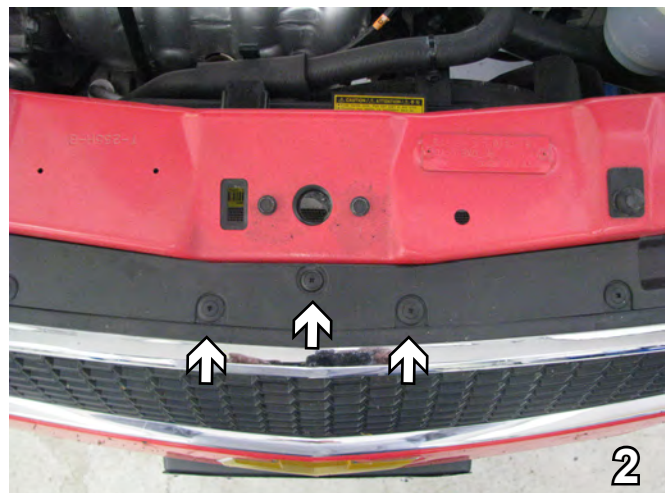

2. In the center of the plastic grille cover on the top side of the fascia, remove three plastic push pins. Lift the cover and set it and the pins aside to be reinstalled later.

Handling of some cosmetic parts when installing this product may require the use of protective covers, rags, specialty tools, etc. to prevent damage.

Do not use the towed vehicle for storing luggage, equipment, etc. This may cause you to exceed the towing capacity of the tow bar, baseplate, and its accessories.

BX1688
2009-11 Chevy Aveo (Including Foglights)
Installation Instructions



3. Inside between the grille and the radiator, remove one push pin. Do this to both sides of the vehicle. Set push pins aside to be reinstalled later.

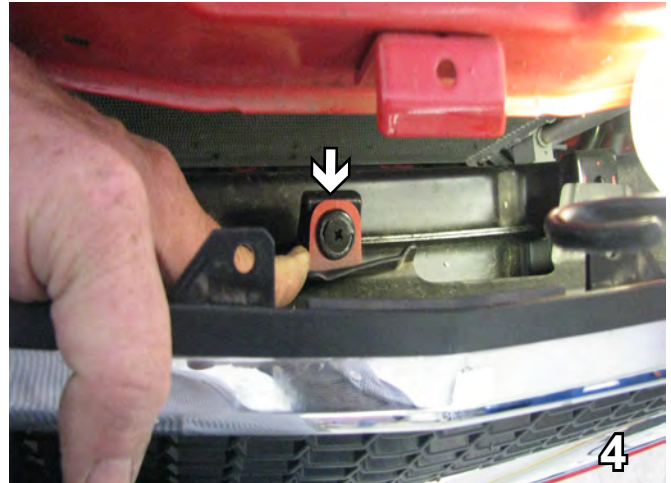

4. Bend the plastic covering out to remove the push pin from the center. Set grille and push pins aside to be reinstalled later.



5. Just forward of the front tire, using a 7MM socket remove one screw. Do this to both sides of the vehicle. Set screws aside to be reinstalled later.



6. Underneath just forward of the front tire, using a 7MM socket remove two metric bolts. Do this on both sides. Set bolts aside to be reinstalled later.



7. Underneath on the bottom side of the bumper going across, remove three push pins. Set pins aside to be reinstalled later.



8. Just forward of the front tire in the wheel well, pull the plastic cover forward. Use a 7MM socket to remove one metric bolt. Do this on both sides of the vehicle. Set the bolts aside to reinstall later.

BX1688
2009-11 Chevy Aveo (Including Foglights)
Installation Instructions

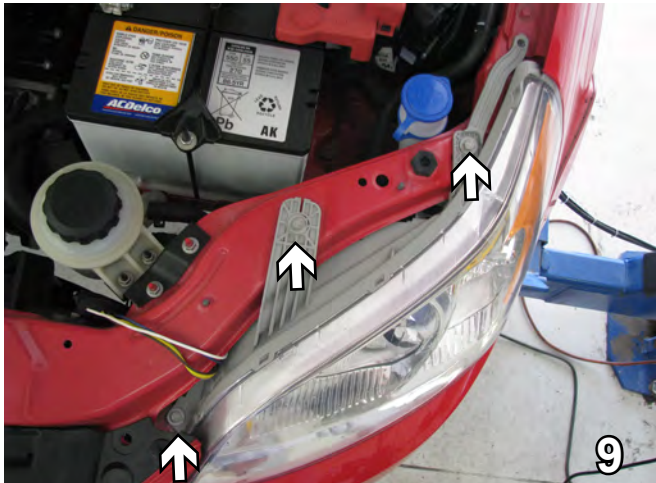

9. Using the 10MM socket, remove three bolts from the top of the headlight assembly. Unplug and set assembly and bolts aside. Do this to both sides of the vehicle.

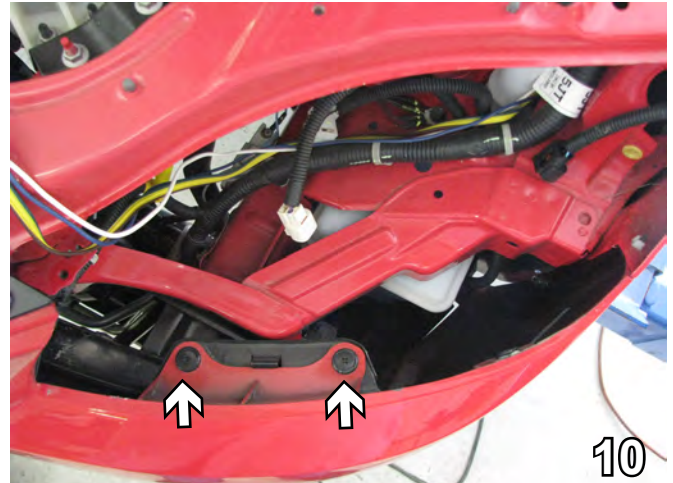

10. Remove two push pins just below headlight assembly. Do this on both sides. Set pins aside to reinstall later.



11. Using the 7MM socket, remove the screw from the corner of the fascia. Do this on both sides. Pull fascia forward and set it and the screw aside carefully to be reinstalled later.

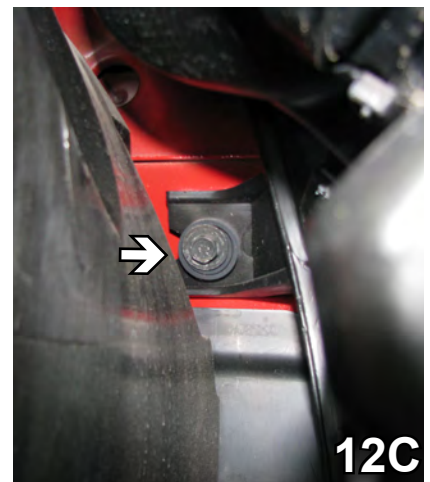

12. On the passenger side, using a 10MM socket remove the two metric bolts and one metric hex nut, disconnect tube and set air baffle aside.

BX1688
2009-11 Chevy Aveo (Including Foglights)
Installation Instructions

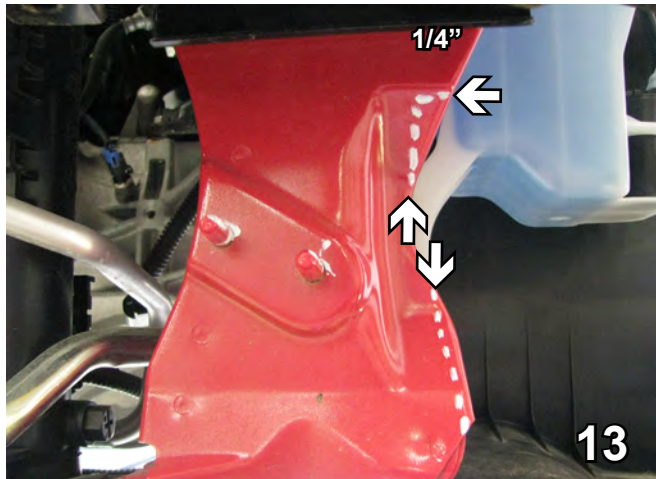

13. Cut 1/4" inch across where the frame starts to bow and straight down. Continuing on down trim off 1/4". Do this on both sides.

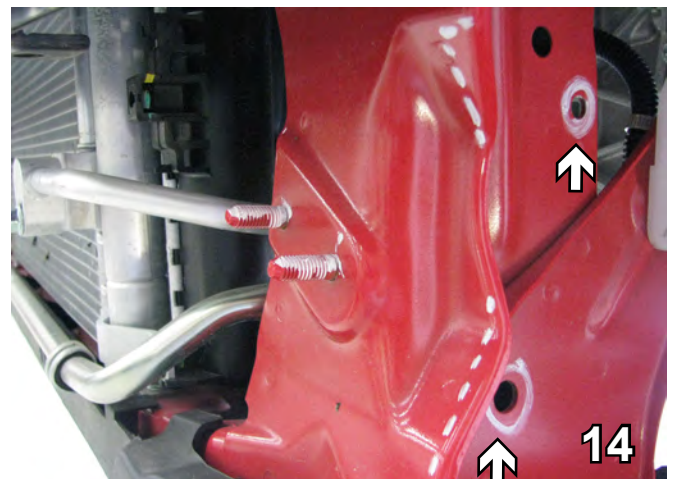

14. Locate these two existing holes on lower frame extension, just above tie down bracket and drill out with the 13/32" drill bit. Do this on both sides.



15. On the back of the lower frame extension, undo the hose clip and using the 1 1/4" hole saw drill out the small hole. Do this on both sides.



16. On the back side of the fascia, cut 3/8" up from the protruding edge and down to the contour then straight across. Do this on both sides.

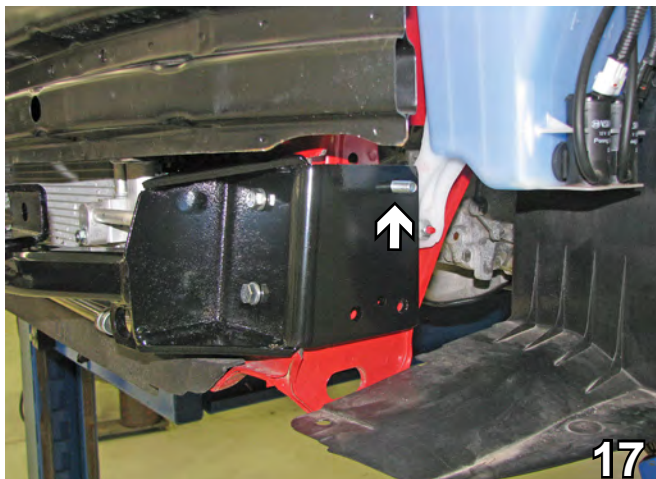

17. Align the baseplate with the upper existing hole on the side of the frame extension. Insert 3/8-16 x 2" hex bolt through baseplate's top hole and 3/4" spacer between the frame and the baseplate. Install 3/8" lock washer and 3/8-16 hex nut on the back side of webbing, tighten with loctite. On the driver side, the bolt comes through the frame to the outside of the baseplate. Be sure the baseplate is level with respect to the vehicle frame.

BE SURE TO USE LOCTITE® RED ON ALL BOLTS BEFORE TIGHTENING. TIGHTEN ALL BOLTS ACCORDING TO THE TORQUE CHART ON THE FRONT PAGE OF THESE INSTRUCTIONS OR ON PAGE 3 OF THE BASEPLATE TOWING GENERAL INSTRUCTIONS.

When using power drills be aware of the dangers of torque and drill bit length.

BX1688

2009-11 Chevy Aveo (Including Foglights)

Installation Instructions

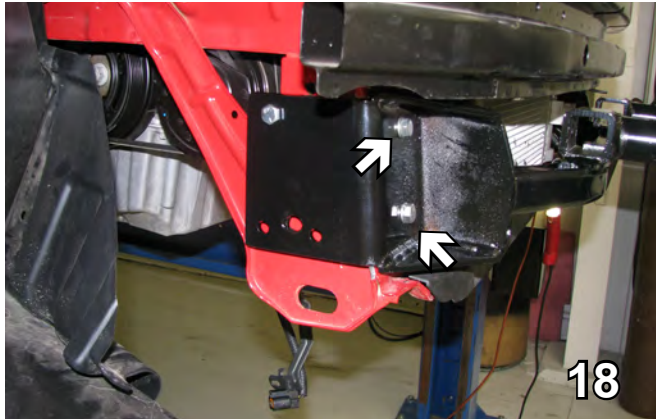

18. Using the baseplate as a template, drill the two holes on the front of baseplate with the 13/32" drill bit. Insert the 3/8-16 nut plates into the 1 1/2" drilled hole in lower frame extension to tighten with 3/8-16 x 1 1/4" bolts and 3/8" lock washers, both sides. Use loctite on bolts.



19. Drill out the two bottom holes on the side. Insert 3/8-16 x 2" hex bolt and 3/8" lock washer through the front side hole (white arrow), through 1/2" spacer into 3/8-16 nut plate. Insert 3/8-16 x 1 1/2" hex bolt into back side hole (gray arrow), through 1/2" spacer tighten with 3/8" lock washer and hex nut, both sides. Be sure and use loctite on all bolts. On the driver side the bolts are turned around.

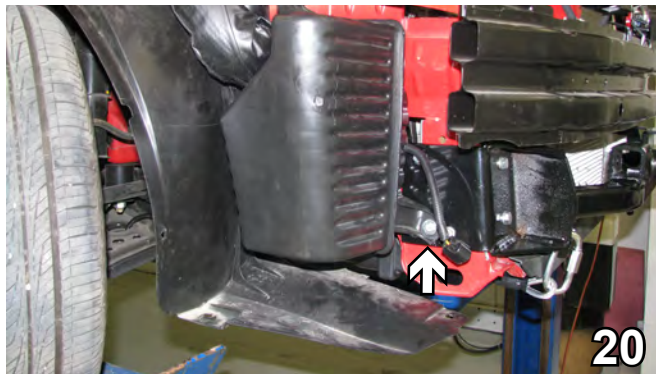

20. Reinstall air baffle on passenger side using the 1/4-20 x 2 1/2" hex bolt, 1/4" flat washer, 1/4" lock washer and 1/4-20 hex nut on front bolt location as shown on page 2. Use the existing hex nut and hex bolt for the back bolt locations. Be sure the connecting tube is properly installed.



21. Attach the permanent baseplate safety cables to the provided convenience link on the baseplate. The photo above shows the recommended installation of the cables to frame of vehicle. Additional options may interfere with suggested mounting; in this case secure the cables to a solid piece of the frame as described in the instructions included with the permanent baseplate safety cables. Be sure the safety cables do not rub against any hoses or moving parts. Do this to both sides.

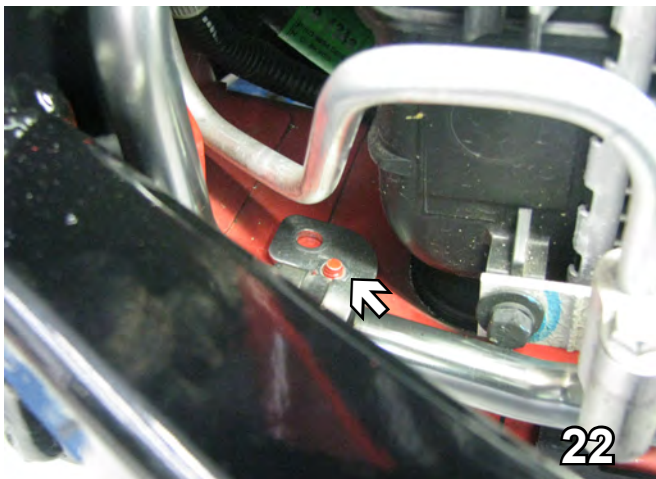

22. On the passenger side only, unbolt the power steering coolant line. Measure 3/4" back, drill a hole and reattach.

BX1688

2009-11 Chevy Aveo (Including Foglights)

Installation Instructions

Be sure that **ALL** electrical connections are plugged in properly and functioning **BEFORE** installing the fascia.

DEALER or INSTALLER:
Be certain the user receives the instruction sheets for their products.

Install the tow bar and safety cables according to the instructions provided in their packages. When demonstrating this to the customer, be sure to include all the contents and packages.

Do **NOT** substitute other devices if the tow bar pins and clips are misplaced.



Shown without removable tabs installed.

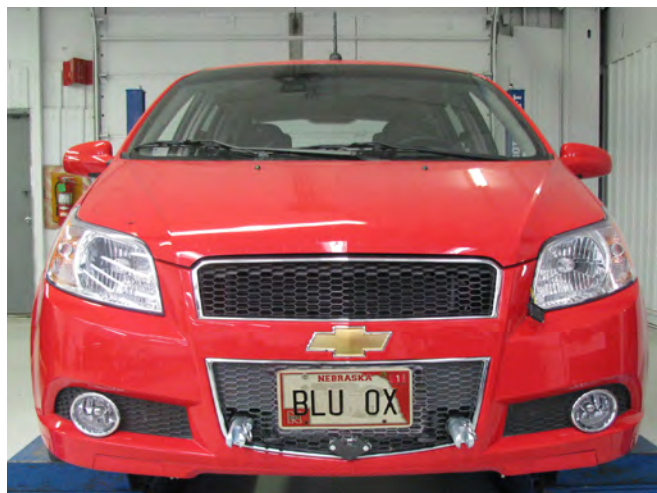

Shown with removable tabs installed.

CUSTOMER SERVICE COMMITMENT

Blue Ox is committed to providing you with exceptional customer care throughout your lifetime with our products. Our team is here to assist you with any questions you may have regarding the performance of your product. Simply call (402) 385-3051 and you can speak with our customer care team.

Additionally, please visit our website to see which rallies our Destination America team will be attending. For a nominal fee, our service technician will service your towing system to ensure it's in proper working condition. Also, as a commitment to our customers, should you visit our factory, you can stay at our full service Blue Ox campground at no charge along with enjoying a factory tour.

Again, thank you for being our customer and for the confidence you have shown in the performance of our products. It is because of customers like you we enjoy the success we have today.

If the baseplate is in an accident, it must be replaced. DO NOT use it again! An accident can cause unseen damage and using it again could result in more damage or serious injury. DO NOT use the baseplate if it is damaged or missing parts.



© 2011 Blue Ox
One Mill Road, Industrial Park
Pender, Nebraska 68047
Phone: (402) 385-3051 • Fax: (402) 385-3360
www.blueox.com