



BX1703

2012-13 Chevy Sonic Turbo

Installation Instructions

Please read BOTH these Installation Instructions and the General Instructions before attempting to install or operate this equipment.

Serial Number

- Blue Ox® towing products and accessories are intended to be installed by Blue Ox® Dealers who are familiar with our products and have the equipment necessary and knowledge to do “fit work”. When necessary Blue Ox® Dealers can be found at www.blueox.com or by contacting our Customer Care Department at (402) 385-3051.
- Many Blue Ox® baseplates are designed to use existing holes and hardware to mount the baseplate to the towed vehicle. Even though bolts are there, do not assume they are adequate for baseplate mounting. Always use hardware supplied in the hardware kit and existing hardware specified in the Baseplate Installation Instructions.

Attachment Tab Height: 13.5”
Attachment Tab Width: 18”

Bolt Torque Specifications		
Torque in Foot-Pounds for Metric Bolts		
Bolt Size	Grade 8.8	Grade 10.9
6MM	6	8
8MM	16	22
10MM	31	40
12MM	54	70
14MM	89	117

Confirm the towability and pre-towing procedures for your vehicle with the owner’s manual or contact the vehicle’s manufacturer for specific towing procedures.

Bolt Torque Specifications		
Torque in Foot-Pounds for Inch Bolts		
Bolt Size	Grade 5	Grade 8
1/4”	10	14
5/16”	19	29
3/8”	33	47
7/16”	54	78
1/2”	78	119
5/8”	154	230



If the front of your vehicle looks different than this, call us at (402) 385-3051.

WARNING

Failure to read and follow these instructions could result in separation of the towed vehicle from the tow bar, causing property damage, loss of towed vehicle, personal injury or death.



BX1703

2012-13 Chevy Sonic Turbo

Installation Instructions

Tools Required		
10MM Socket	13MM Socket	9/16" Socket
T20 Torx	Torque Wrench	Large Vise Grips
Tape Measure	Drill	Flat Screwdriver
13/32" Drill Bit	1/4" Drill Bit	Phillips Screwdriver
Utility Knife	Reciprocating Saw	Loctite® RED

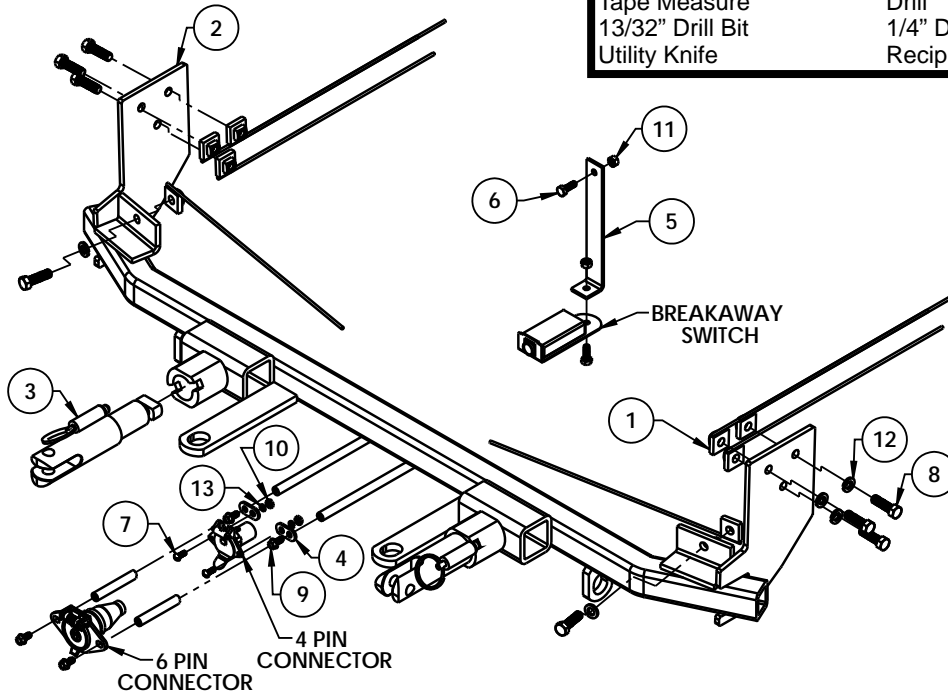

Item No.	Part No.	Description	Qty.
1.....	61-5208.....	3/8"-16 Nut Plate.....	8
2.....	61-7004.....	BX1703 Baseplate.....	1
3.....	62-3468.....	Attachment Tab with Hole.....	2
4.....	101-5822.....	4 Way Connector.....	2
5.....	102-7282.....	Breakaway Bracket.....	1
6.....	201-0050.....	1/4"-20 x 3/4" Hex Head Bolt, Grade 5, ZP.....	2
7.....	201-0192.....	#10-32 1/2" Round Slotted Head Screw.....	2
8.....	201-0368.....	3/8"-16 x 1-1/4" Hex Head Bolt, Grade 5.....	8
9.....	201-0553.....	1/4"-20 x 1/2" Hex Wshd Type F TCS Bolt.....	2
10.....	202-0047.....	#10-32 Hex Nut.....	2
11.....	202-0102.....	1/4"-20 Hex Nylon Insert Nut, ZP.....	2
12.....	203-0010.....	3/8" Lock Washer, ZP.....	8
13.....	203-0054.....	#10 Lock Washer.....	2
14.....	226-0046(not shown).....	Class III Safety Cables.....	2
15.....	229-0359(not shown).....	3/8" Quicklink, ZP.....	2
16.....	290-0437(not shown).....	Black Cap Plug Receiver.....	1
17.....	293-1339(not provided).....	Breakaway Switch.....	1
18.....	294-0805(not provided).....	4 Pin Connector.....	1
19.....	294-0902(not provided).....	6 Pin Connector.....	1

Important:

Use only genuine factory replacement parts on your baseplate. Do NOT substitute homemade or non-typical parts. If a bolt is lost or in need of replacement, for your safety and the preservation of your baseplate, be sure to use a replacement bolt of the same grade (In most cases it will be Grade 5, please reference the parts list above). Replacement parts may be ordered through your nearest Blue Ox® Dealer or Distributor, or call our Customer Care Team at (402)385-3051. Failing to follow and/or altering these installation instructions in either installation or required equipment will void the manufacturer's warranty.



BX1703 2012-13 Chevy Sonic Turbo Installation Instructions

Removable Tabs: Motorhome mount tow bars are recommended for use with this baseplate. Due to the design of the removable tabs, the RangeFinderII, Acclaim, and Ambassador tow bars can not be used. Adapters, except the BX8833, BX88262 and BX88151, can not be used with this baseplate.

Instruction Notes: The fascia, steel fascia support and part of the bellypan are removed and reinstalled during installation of the baseplate. Drilling is required. Trimming is required

The dimensional variations between otherwise identical vehicles can be considerable. While the baseplate was designed for easy installation, it may be necessary to tailor the baseplate slightly to compensate for auto manufacturer's tolerances. These minor adjustments may include filing a hole slightly, bending electrical rods or bending end plates.

The BX8869 Bulb and Socket Wiring Kit is recommended for this vehicle.



Possible location for the Bulb and Socket Wiring Kit (BX8869).

Handling of some cosmetic parts when installing this product may require the use of protective covers, rags, specialty tools, etc. to prevent damage.

Do not use the towed vehicle for storing luggage, equipment, etc. This may cause you to exceed the towing capacity of the tow bar, baseplate, and its accessories.

Installation Instructions:

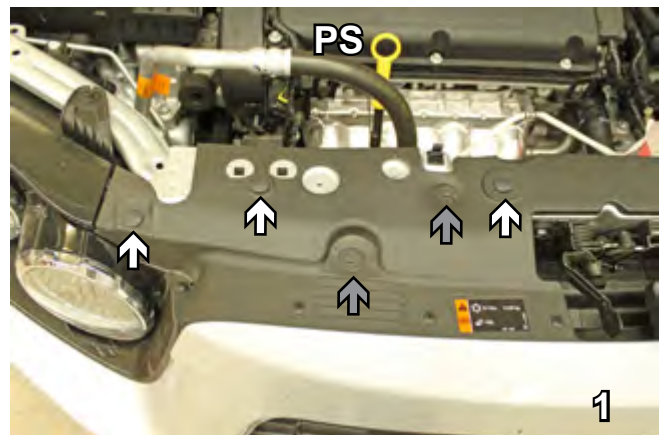
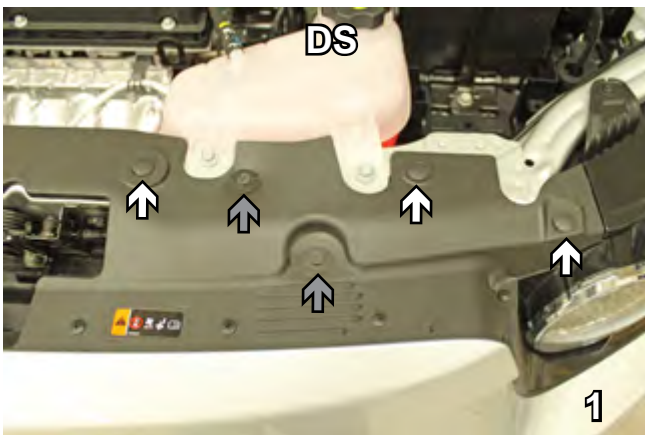

1. With flat screwdriver, remove six push pins from the top of the plastic radiator cover (white arrows). With 10MM socket, remove four bolts from the top of the plastic radiator cover (gray arrows). Set push pins and bolts aside to be reinstalled later.

BX1703

2012-13 Chevy Sonic Turbo Installation Instructions

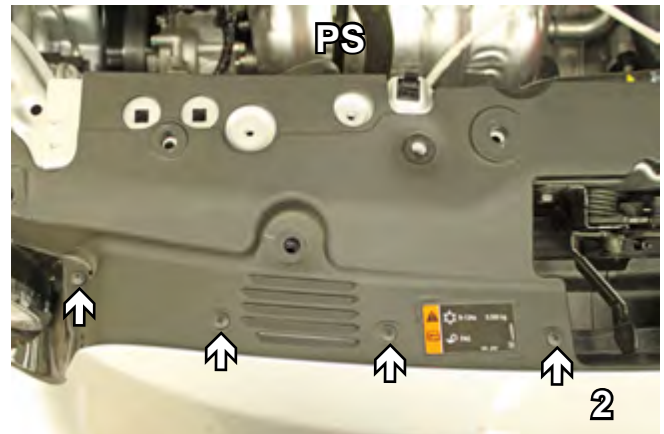
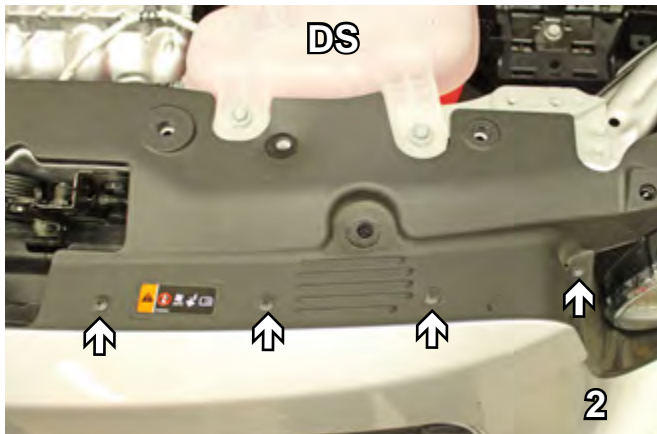

2. With a Phillips screwdriver, remove eight push pins on top of plastic radiator cover. Set push pins aside to be reinstalled later.



3. In front of the tire, using T20 Torx, remove four bolts. Do this to both sides of the vehicle. Set bolts aside to be reinstalled later.

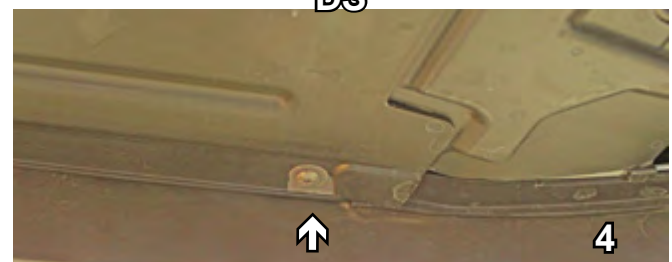
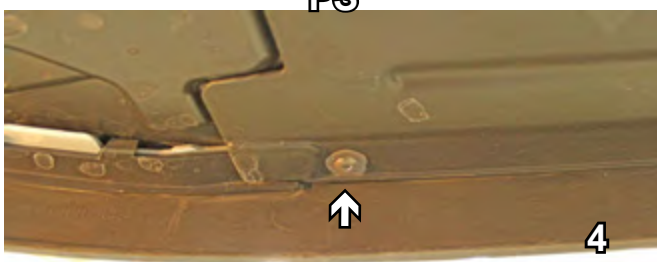

4. Underneath fascia, using T20 Torx, remove six bolts. Set bolts aside to be reinstalled later.

BX1703

2012-13 Chevy Sonic Turbo Installation Instructions

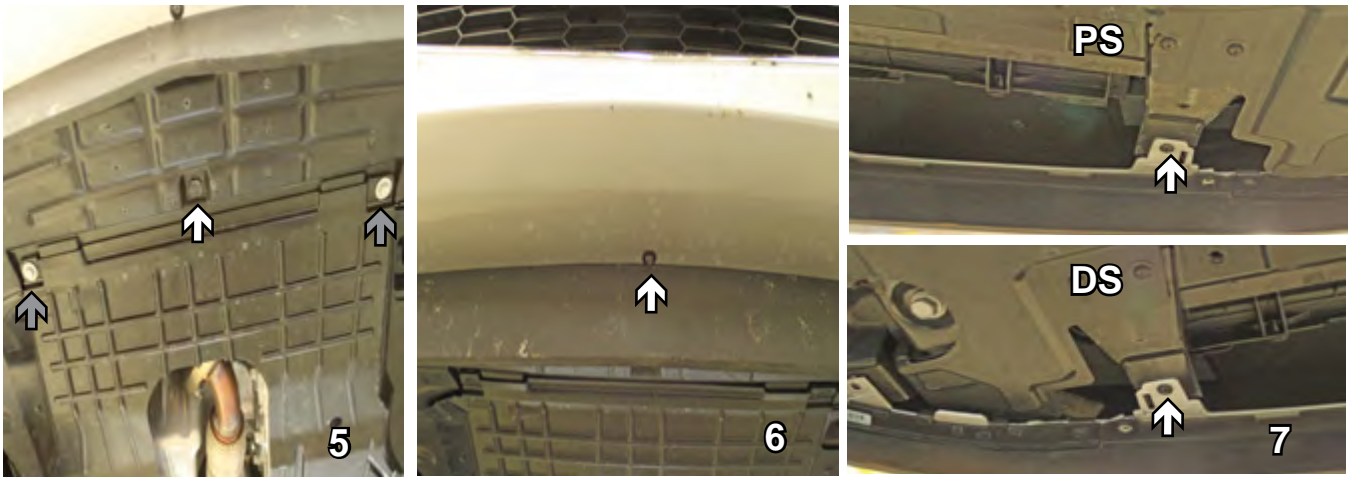

5. On the bellypan, with flat screwdriver, remove one push pin (white arrow) and with a 13MM socket, remove two bolts (gray arrows). Set push pin and bolts aside to be reinstalled later.
6. Underneath the license plate, with T20 Torx, remove one bolt. Set the bolt aside to be reinstalled later.
7. After the removal of the bolt in Instruction #6, the front portion of the bellypan can be removed. Set this portion of the bellypan aside to be reinstalled later. With a Phillips screwdriver, remove two bolts that are now visible after the removal of the bellypan. Set bolts aside to be reinstalled later.



8. To remove fascia, lift up and pull out. Place the fascia on a flat, sturdy surface until after baseplate installation.

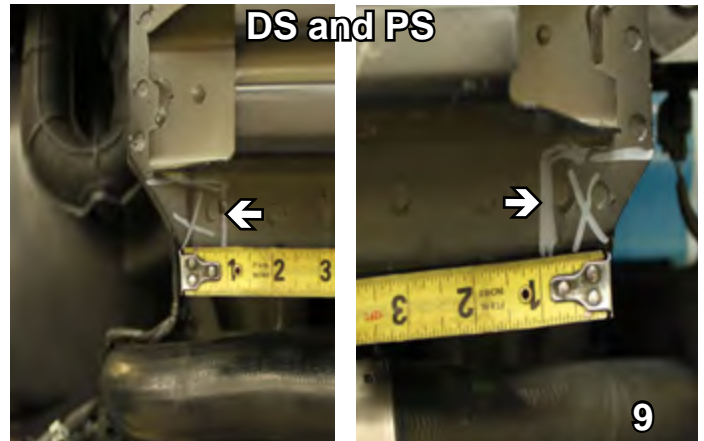

9. With a reciprocating saw, notch over 1" from the edge and upward to just slightly under the bumper. Do this on **BOTH** sides of the vehicle.



BX1703 2012-13 Chevy Sonic Turbo Installation Instructions

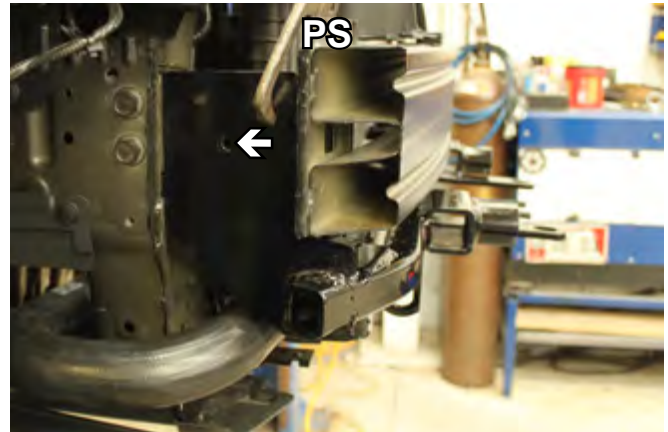
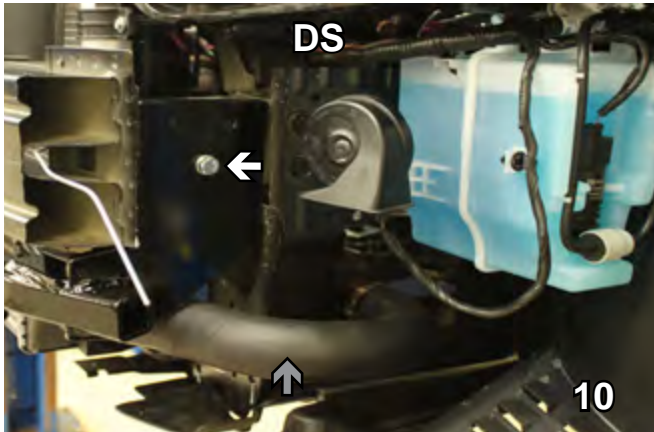

10. Slide baseplate up onto the frame of the vehicle. The baseplate support tabs on the front of the baseplate should be directly under the bumper. Be sure the baseplate is level.

Using a 13/32" drill bit, drill the bottom hole and insert the 3/8"-16 x 1-1/4" hex head bolt, 3/8" lock washer and 3/8"-16 nut plate. Verify the baseplate is still level and tighten all fasteners securely. Do this on **BOTH** sides of the vehicle.

Drill the remaining two (2) holes at the top of the endplates and insert the 3/8" hardware.

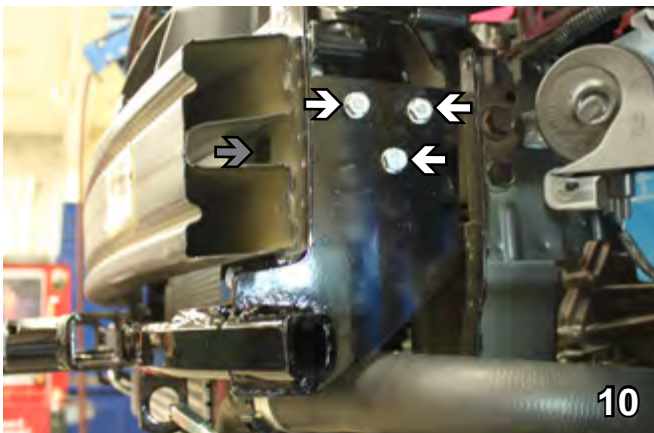

The nut plate will be inserted through the square opening at the backside of the bumper (gray arrow).

BE SURE TO USE LOCTITE® RED ON ALL BOLTS BEFORE TIGHTENING. TIGHTEN ALL BOLTS ACCORDING TO THE TORQUE CHART ON THE FRONT PAGE OF THESE INSTRUCTIONS OR ON PAGE 3 OF THE BASEPLATE TOWING GENERAL INSTRUCTIONS.

When using power drills be aware of the dangers of torque and drill bit length.



BX1703

2012-13 Chevy Sonic Turbo

Installation Instructions



11. Attach the permanent baseplate safety cables to the provided convenience link on the baseplate. Be sure the safety cables do not rub against any hoses or moving parts. Do this to both sides of the vehicle.
12. Hold fascia up as close to original position as possible. With a utility knife, trim fascia to allow baseplate attachment tabs and breakaway, if applicable, to come through. Convenience links should come through the front of the fascia and not require any additional trimming.
13. Reinstall the bellypan and front fascia.



Shown with removable tabs installed



Shown without removable tabs installed

DEALER or INSTALLER:
Be certain the user receives the instruction sheets for their products.

Be sure that **ALL** electrical connections are plugged in properly and functioning **BEFORE** installing the fascia.



BX1703

2012-13 Chevy Sonic Turbo Installation Instructions

CUSTOMER SERVICE COMMITMENT

Blue Ox is committed to providing you with exceptional customer care throughout your lifetime with our products. Our team is here to assist you with any questions you may have regarding the performance of your product. Simply call (402) 385-3051 and you can speak with our customer care team.

Additionally, please visit our website to see which rallies our Destination America team will be attending. For a nominal fee, our service technician will service your towing system to ensure it's in proper working condition. Also, as a commitment to our customers, should you visit our factory, you can stay at our full service Blue Ox campground at no charge along with enjoying a factory tour.

Again, thank you for being our customer and for the confidence you have shown in the performance of our products. It is because of customers like you we enjoy the success we have today.

If the baseplate is in an accident, it must be replaced. DO NOT use it again! An accident can cause unseen damage and using it again could result in more damage or serious injury. DO NOT use the baseplate if it is damaged or missing parts.



© 2011 Blue Ox
One Mill Road, Industrial Park
Pender, Nebraska 68047
Phone: (402) 385-3051
Fax: (402) 385-3360
www.blueox.com