



# BX1710

## 2014 Chevy Silverado 1500 Installation Instructions

Serial Number

**Attachment Tab Height: 18"**

**Attachment Tab Width: 32-1/2"**

**Please read BOTH these Installation Instructions and the General Instructions prior to installing or operating this equipment.**

- Blue Ox® towing products and accessories are intended to be installed by Blue Ox® Dealers who are familiar with our products and have the equipment and knowledge necessary to do "fit work". If needed, Blue Ox® Dealers can be found at [www.blueox.com](http://www.blueox.com) or by contacting our Customer Care Department at (402) 385-3051.
- Many Blue Ox® baseplates are designed to use existing holes and hardware to mount the baseplate to the towed vehicle. Even though bolts are there, do not assume they are adequate for baseplate mounting. Always use the hardware supplied in the hardware kit and existing hardware as specified in the installation instructions.

**Bolt Torque Specifications**  
Torque in Foot-Pounds for Inch Bolts

Bolt Size	Grade 5	Grade 8
1/4"	10	14
5/16"	19	29
3/8"	33	47
7/16"	54	78
1/2"	78	119
5/8"	154	230
3/4"	257	380



**Bolt Torque Specifications**  
Torque in Foot-Pounds for Metric Bolts

Bolt Size	Grade 8.8	Grade 10.9
6MM	6	8
8MM	16	22
10MM	31	40
12MM	54	70
14MM	89	117
16MM	161	230
18MM	222	318

If the front of your vehicle looks different than this, please contact us at (402)385-3051.

**Reference your vehicle owner's manual for manufacturer's towing specifications.**

**⚠ WARNING**

Failure to read and follow these instructions could result in separation of the towed vehicle from the tow bar, causing property damage, loss of towed vehicle, personal injury or death.

BX1710  
2014 Chevy Silverado 1500  
Installation Instructions

**Instruction Notes:** The fascia, fascia cover and bumper are removed and reinstalled for the baseplate installation. Some drilling and trimming is required.

Place all components that are removed on a flat, sturdy surface. All items will be reinstalled unless otherwise noted after the baseplate is installed.

The dimensional variations between otherwise identical vehicles can be considerable. While the baseplate was designed for easy installation, it may be necessary to tailor the baseplate slightly to compensate for vehicle manufacturer's tolerances.

The BX8869 Tail Light Wiring Kit is recommended for this vehicle.



Drill a hole according to the tail  
light wiring kit instructions.

### **NOTICE**

- Handling of some cosmetic parts when installing this product may require the use of protective covers, rags, specialty tools, etc. to prevent damage.
- When using power drills be aware of the dangers of torque and drill bit length.
- When using a reciprocating saw be aware of objects behind the cutting surface.
- Use a good quality paint to spray cut edges of frame to prevent rusting.
- Be sure that **ALL** electrical connections are plugged in and accessories are functioning properly before reinstalling the fascia.
- The baseplate is computer tested to your vehicle's GVWR, exceeding this weight will void the manufacturer's warranty.
- Be sure to use Loctite® Red on all bolts before tightening. Tighten all bolts according to the torque chart provided.
- Dealer or installer be certain the user receives these instruction sheet.
- If the baseplate is in an accident, it must be replaced. **DO NOT** use it again! An accident can cause unseen damage and using it again could result in more damage or serious injury. **DO NOT** use the baseplate if it is damaged or missing parts.

# BX1710

## 2014 Chevy Silverado 1500

### Installation Instructions

#### Tools Required

Large Vise Grip  
 Flat Screwdriver  
 Torque Wrench  
 Drill  
 Tape Measure  
 Loctite® RED  
 1/2" Drill Bit  
 7MM Socket  
 10MM Socket  
 15MM Socket  
 18MM Socket  
 18MM Wrench  
 3/4" Socket  
 3/4" Wrench

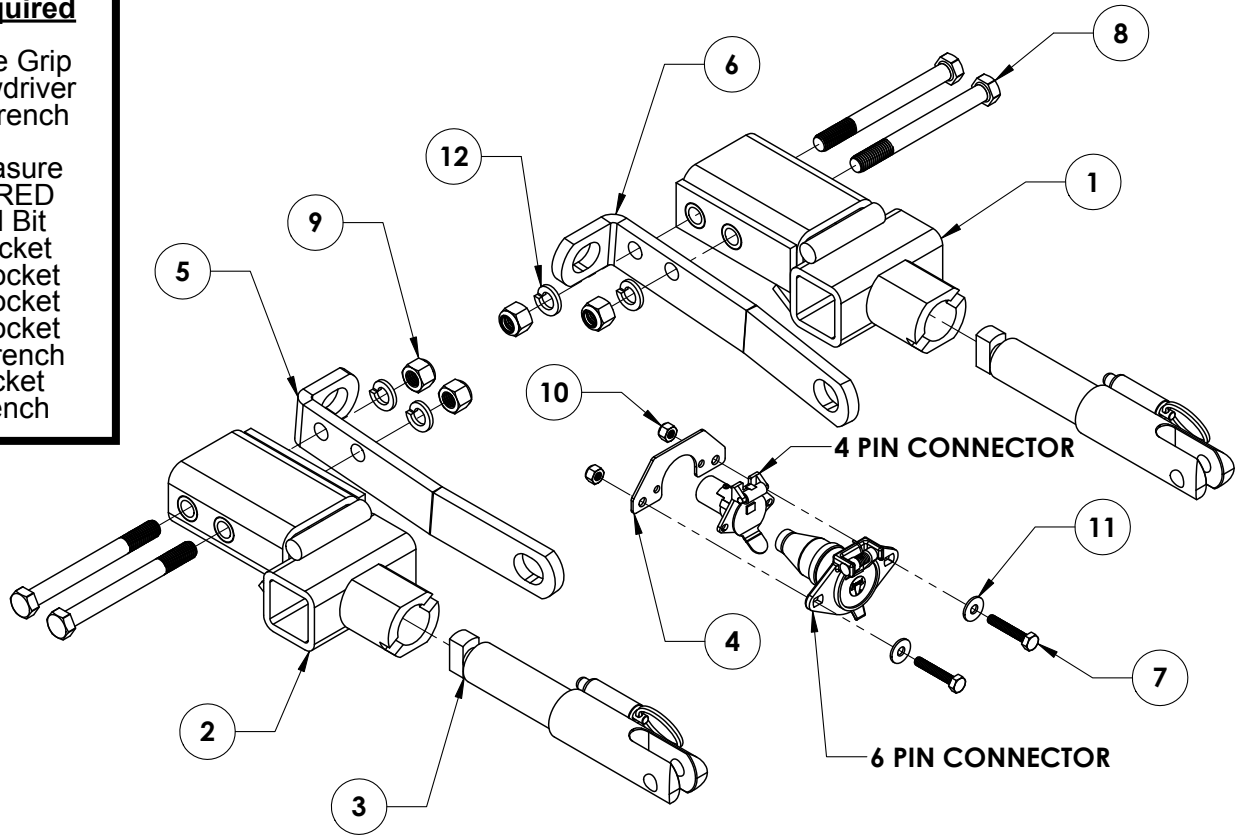

Item No.	Part No.	Description	Qty.
1.....	61-7244.....	BX1710 Driver Side Baseplate.....	1
2.....	61-7245.....	BX1710 Passenger Side Baseplate.....	1
3.....	62-3468.....	Attachment Tab Assembly with Hole.....	2
4.....	101-7756.....	4-Way Electrical Bracket.....	1
5.....	102-6797.....	Convenience Link, PS.....	1
6.....	102-6798.....	Convenience Link, DS.....	1
7.....	201-0448.....	1/4"-20 x 1-1/2" Hex Head Bolt, Grade 5, ZP.....	2
8.....	201-0786.....	1/2"-13 x 5" Hex Head Bolt, Grade 5, ZP.....	4
9.....	202-0094.....	1/2"-13 Hex Nylon Lock Nut, ZP.....	4
10.....	202-0102.....	1/4"-20 Hex Nylon Lock Nut, ZP.....	2
11.....	203-0001.....	1/4" Flat Washer, ZP.....	2
12.....	203-0012.....	1/2" Lock Washer, ZP.....	4
13.....	226-0049(not shown).....	Class IV Safety Cables.....	2
14.....	229-0512(not shown).....	1/2" Quicklink, ZP.....	2
15.....	290-0437(not shown).....	Black Cap Plug Receiver.....	2

#### **Important:**

Use only genuine factory replacement parts on your baseplate. Do **NOT** substitute homemade or non-typical parts. If a bolt is lost or in need of replacement, for your safety and the preservation of your baseplate, be sure to use a replacement bolt of the same grade (In most cases it will be Grade 5, please reference the parts list above). Replacement parts may be ordered through your nearest Blue Ox® Dealer or Distributor. Failing to follow and/or altering these installation instructions in either installation or required equipment will void the manufacturer's warranty. Towing behind a non-motorized vehicle will void the warranty.

BX1710  
2014 Chevy Silverado 1500  
Installation Instructions

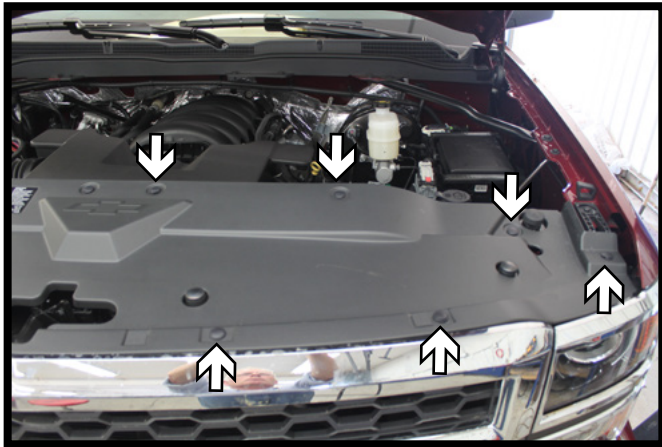

1. Remove the twelve (12) push pins from the fascia cover. There are six (6) on each side. Set the cover aside.

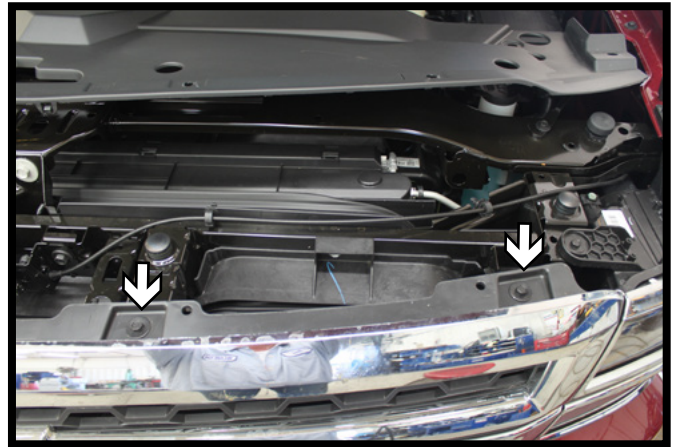

2. Using a 10MM socket, remove the four (4) screws from the top edge of the fascia. There are two (2) on each side.

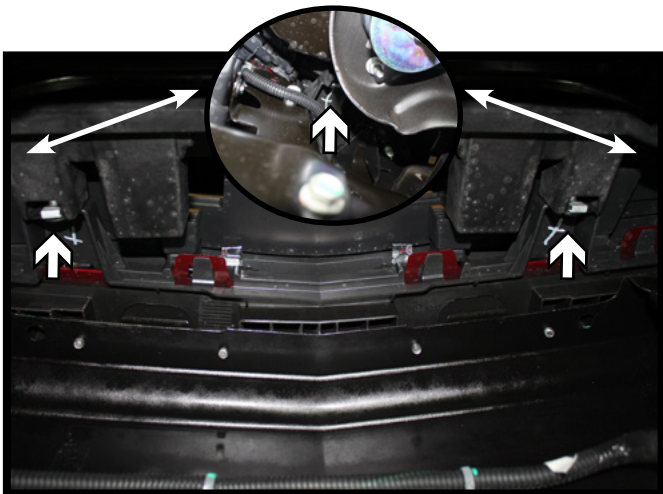

3. Using a 10MM socket, remove the four (4) screws from the underside of the fascia. There are two (2) in the middle and one (1) on each side.

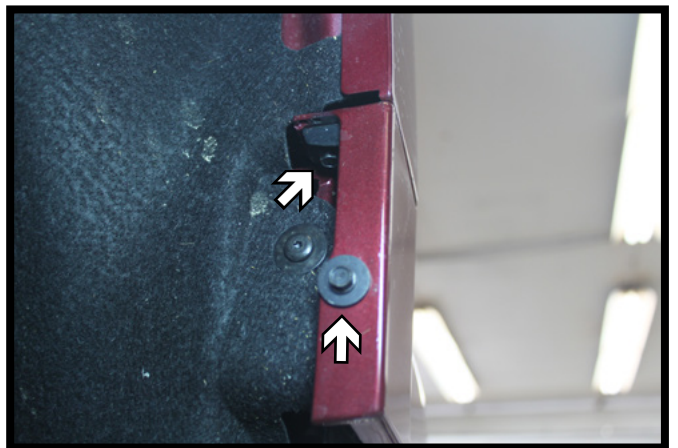

4. Using a 7MM socket, remove the two (2) screws from the wheel well. Do this on both sides of the vehicle. Unsnap the fascia from the body and set aside.

BX1710  
2014 Chevy Silverado 1500  
Installation Instructions

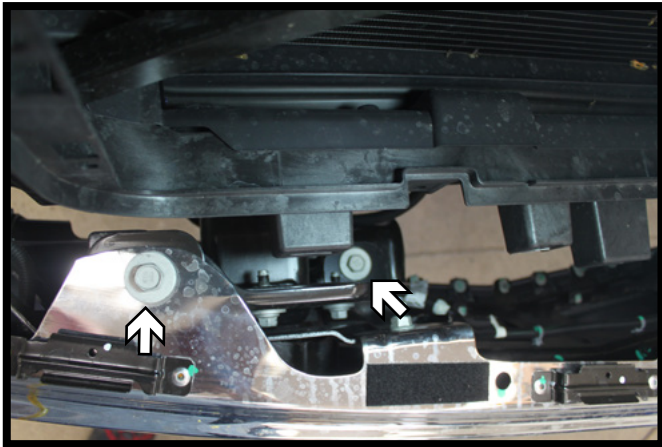

5. Using a 18MM socket, remove the four (4) bolts from the top of the bumper. There are two (2) on each side.

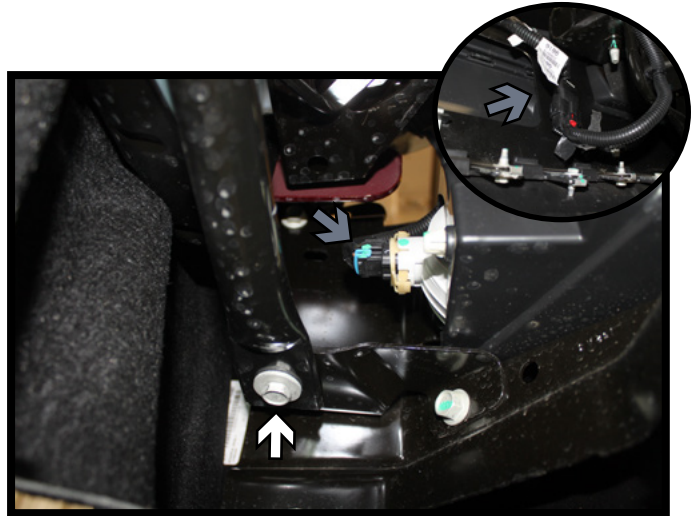

6. Using a 15MM socket, remove the bolt from the bumper reinforcement bar. Do this on both sides of the vehicle. Disconnect the running lights/electrical connections (gray) and set the bumper aside.

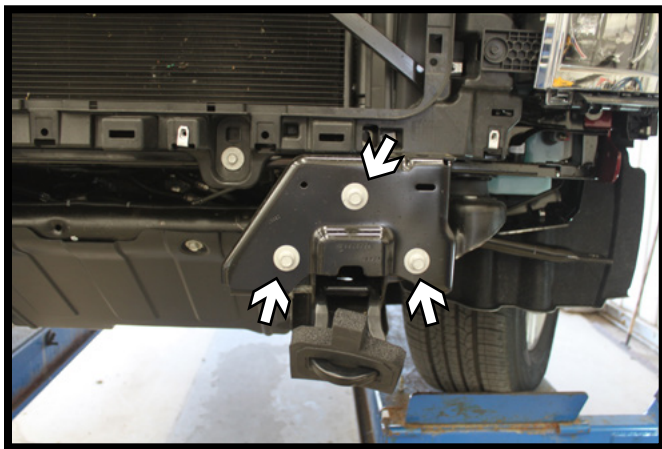

7. Using a 15MM socket, remove the three (3) bolts from the cover plate. Do this on both sides of the vehicle.

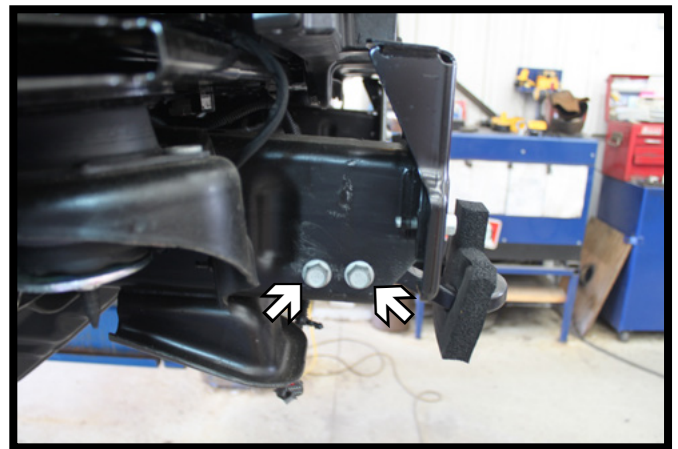

8. Using a 18MM socket/wrench, remove the two (2) bolts from the tow hook. Do this on both sides of the vehicle.

BX1710  
2014 Chevy Silverado 1500  
Installation Instructions

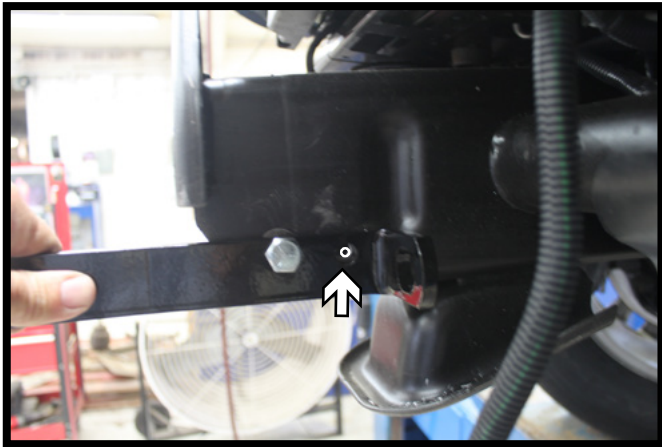

9. Place the convenience link against the frame and pin the front hole with a 1/2" bolt. Level the link and mark the frame for the rear hole. Do this on the inside passenger and outside driver frame rails. Using a 1/2" drill bit, drill out both holes to line up with the existing holes on the other side of the frame.

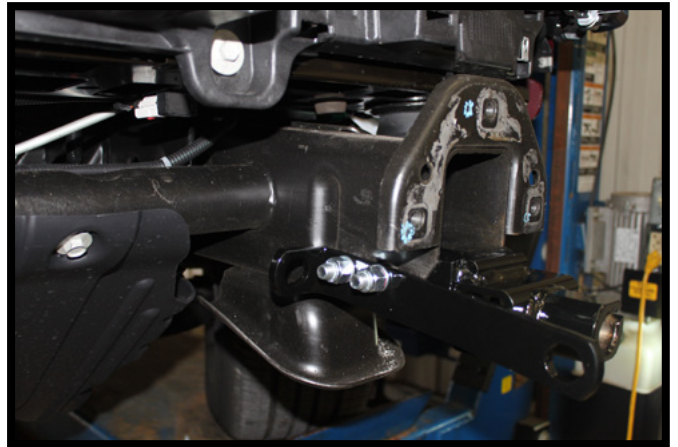

10. Position the appropriate baseplate into the tow hook pocket. Install 1/2"-13 x 5" bolts from the outside of the frame with the convenience link, 1/2" lock washers and lock nuts on the inside of the frame. Tighten down until the frame squeezes against the baseplate. Do this on both sides of the vehicle.

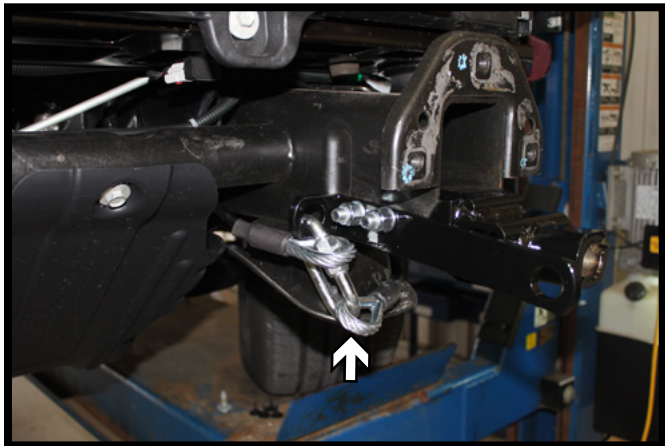

11. Attach the permanent baseplate safety cables to the provided convenience link on the baseplate. The photo above shows the recommended installation of the cables to frame of vehicle. Additional options may interfere with suggested mounting; in this case, secure the cables to a solid piece of the frame as described in the instructions included with the permanent baseplate safety cables. Be sure the safety cables do not rub against any hoses or moving parts. Do this on **BOTH** sides of the vehicle.

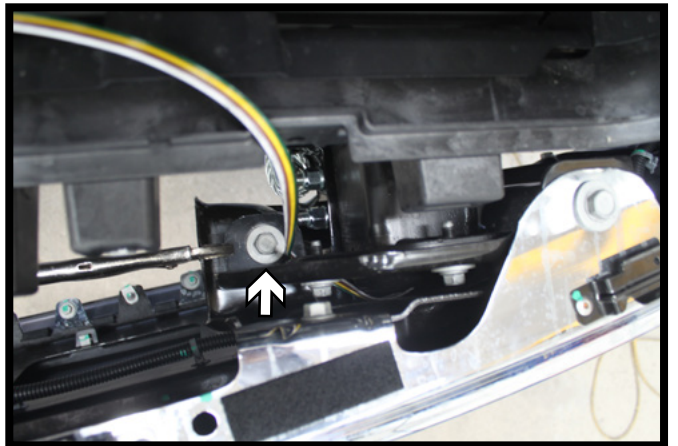

12. Reinstall the bumper onto the vehicle. Install the top outer bolts, then push in on the bottom of the bumper to line up the inner bottom bolts. Clamp the bumper when the hole is lined up and reinstall the lower bolts. Continue to reinstall the bumper bar bolts and reconnecting the electrical connections on the underside of the bumper.

BX1710  
2014 Chevy Silverado 1500  
Installation Instructions



13. **Optional:** Prior to fully reinstalling the fascia. Using a 1/4" drill bit, widen the grille opening to accommodate the plug bolts. Using 1/4" x 1-1/2" bolts with 1/4" washers, install the plug thru the grille. On the backside of the grille, install the electrical bracket and 1/4" locknuts to secure the plug to the grille.



14. Reinstall the fascia and fascia cover.

## CUSTOMER SERVICE COMMITMENT

Blue Ox® is committed to providing you with exceptional customer care throughout your lifetime with our products. Our team is here to assist you with any questions you may have regarding the performance of your product. Simply call (402) 385-3051 and you can speak with our customer care team.

Additionally, please visit our website to see which rallies our Destination America team will be attending. For a nominal fee, our service technician will service your towing system to ensure it's in proper working condition. Also, as a commitment to our customers, should you visit our factory, you can stay at our full service Blue Ox® campground at no charge along with enjoying a factory tour.

Again, thank you for being our customer and for the confidence you have shown in the performance of our products. It is because of customers like you we enjoy the success we have today.

© 2013 Blue Ox  
One Mill Road, Industrial Park  
Pender, Nebraska 68047  
Phone: (402) 385-3051  
Fax: (402) 385-3360  
[www.blueox.com](http://www.blueox.com)