



Baseplate Installation Instructions

BX1839

# 2006 Infinity G35 Installation Instructions

Serial Number

Please read BOTH these Installation Instructions and the General Towing Instructions before attempting to install or operate this equipment.

1. Blue Ox® towing products and accessories are intended to be installed by Blue Ox® Dealers who are familiar with our products and have the equipment and knowledge to do “fit work.” When necessary, Blue Ox® Dealers can be found at [www.blueox.com](http://www.blueox.com) or by contacting our 24/7 Customer Care Department at (888) 425-5382.

Attachment Tab Height: 12 1/2”  
Attachment Tab Width: 24”

2. Many Blue Ox® Baseplates are designed to use existing holes and hardware to mount the baseplate to the towed vehicle. Even though bolts are there, do not assume they are adequate for baseplate mounting. Always use hardware supplied in the hardware kit or existing hardware specified in the Baseplate Towing Installation Instructions.

### Bolt Torque Specifications

Torque in Foot-Pounds per Metric Bolts

Bolt Size	Grade 8.8	Grade 10.9
6MM	6	8
8MM	16	22
10MM	31	40
12MM	54	70
14MM	89	117

Confirm the towability and pre-towing procedures for your vehicle with the owner’s manual or contact the vehicle’s manufacturer for specific towing procedures. You can also contact REMCO for additional information at 1(800)228-2481.

### Bolt Torque Specifications

Torque in Foot-Pounds per Inch Bolts

Bolt Size	Grade 5	Grade 8
1/4”	10	14
5/16”	19	29
3/8”	33	47
7/16”	54	78
1/2”	78	119
5/8”	154	230



## ! WARNING

Failure to read and follow these instructions could result in separation of the towed vehicle from the tow bar, causing property damage, loss of towed vehicle, personal injury or death.

# BX1839

## 2006 Infinity G35

### Installation Instructions

## Parts List

Ref. No.	Qty.	Part #	Description
1	1	61-6367	WLDM'T, BASEPLATE, BX1839
2	2	61-6404	WLDM'T, LOWER BRKT, BX1839
3	2	61-6405	WLDM'T, UPPER BRKT, BX1839
4	8	201-0418	8MM-1.25 X 35MM HEX BOLT GRD.8.8 ZP
5	12	203-0009	5/16 LOCK WASHER, ZP
6	12	203-0002	5/16 FLAT WASHER, ZP
7	8	201-0051	1/2-13 X 1 1/2 HEX BOLT GRD.5, ZP
8	8	203-0012	1/2 LOCK WASHER, ZP
9	6	203-0005	1/2 FLAT WASHER, ZP
10	4	201-0004	5/16-18 X 1 1/4 HEX TAP BOLT GRD.5
11	4	202-0070	5/16-18 HEX FLANGE WHIZ LOCK NUT ZP
12	4	202-0005	1/2-13 HEX NUT, ZP
13	1		Existing Metric Bolt
14	1	201-0553	1/4-20 X 1/2 HX.WSHD.TYPE F TCS, ZP
15	1	201-0192	10-32 X 1/2 SLOT, RD. HD. SCREW
16	1	203-0054	#10 LOCK WASHER
17	1	202-0047	#10-32 HEX NUT
18	1	101-5822	ADAPTER, 4 WAY CONNECTOR
19	2	62-3469	ATT TAB ASSY, REM, SF/LB, 1 HOLE
	2	226-0046	BASEPLATE SAFETY CABLE, 36" CL III (Not Shown)
	2	229-0359	QUICKLINK, 3/8, ZP (Not Shown)
	2	290-0437	RECEIVER, CAP PLUG (BLK)

## Tools Required

Loctite® RED  
 Phillips Screwdriver  
 9/16" Socket  
 3/4" Socket  
 10MM Socket  
 12MM Socket  
 14MM Socket  
 Diagonal Cutters  
 Reciprocating Saw

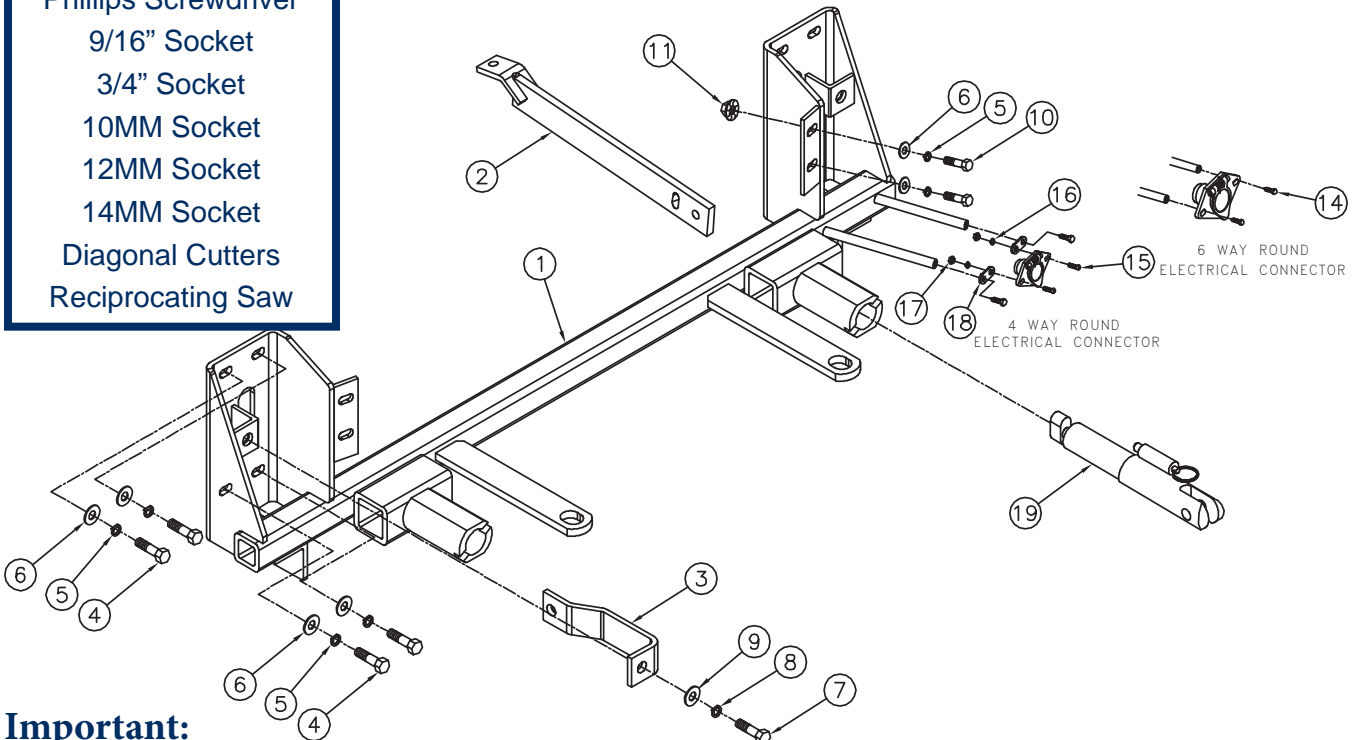

## Important:

Use only genuine factory replacement parts on your baseplate. Do **NOT** substitute homemade or non-typical parts. If a bolt is lost or in need of replacement, for your safety and the preservation of your baseplate, be sure to use a replacement bolt of the same grade (In most cases it will be Grade 5, please reference the parts list above). Replacement parts may be ordered through your nearest Blue Ox® Dealer or Distributor.

# BX1839

## 2006 Infinity G35

### Installation Instructions

#### Vehicle Weight:

The weight of this vehicle is near the Class III, 5,000 lb. rating limitations. Some models, depending on options, may well exceed this 5,000 lb rating. Be sure to confirm the weight of your individual vehicle before towing. As of 1999 the Aventa® II is now 10,000 lbs. and either the Aventa® II or the Aventa® LX tow bar must be used for these applications.

**Tow Bar Adapters are NOT to be used with vehicles weighing over 5,000 lbs.**

**Installation Notes:** The fascia is removed for installation.

The dimensional variations between otherwise identical vehicles can be considerable. While the baseplate was designed for easy installation, it may be necessary to tailor the baseplate slightly to compensate for auto manufacturer's tolerances. These minor adjustments may include filing a hole slightly, bending electrical rods and/ or bending end plates.

The BX8948 Diode Wiring Kit is recommended for this vehicle.

#### Installation Instructions:

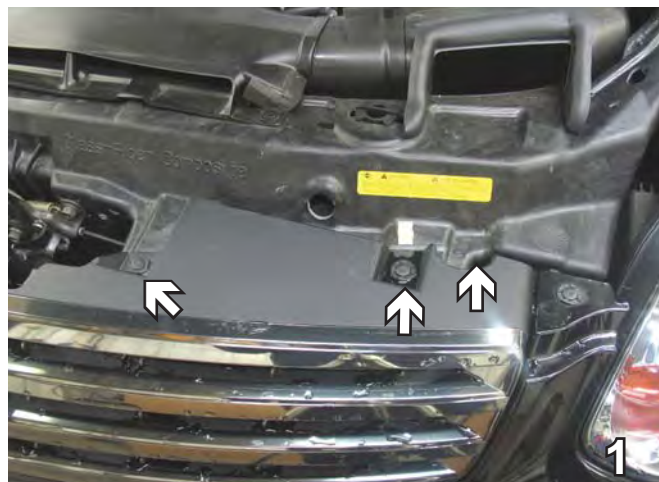

1. Using a flat screwdriver, remove 6 pushpins, 3 on each side in exactly the same spot (driver's side shown) from the flat plastic piece on top of fascia. Set pushpins and flat plastic aside to be reinstalled later.



2. Underneath the fascia remove the 10 bolts all the way across the bottom (driver's side shown) using a 10MM socket. Set bolts aside for later installation.

BX1839  
2006 Infinity G35  
Installation Instructions

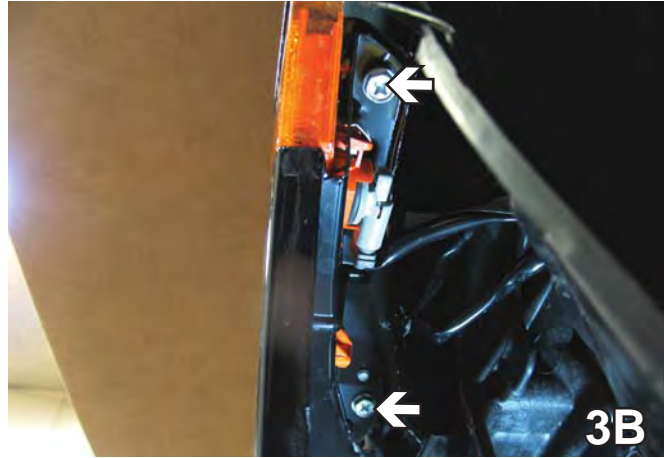

3. Pry out the wheel well cover. Use a 10MM socket or a Phillips Screw Driver to remove two bolts forward of the front tire. Set bolts aside to be reinstalled later. Do this to both sides of the vehicle. Pull the fascia corners out to the side of the vehicle, both sides, then pull fascia forward and carefully set aside for later reinstallation.



4. Remove styrofoam from metal bumper and styrofoam shroud from lower air dam. Set both aside for later reinstallation.
5. Remove the lower air dam (grey arrow). Using a flat screwdriver, remove the 3 push pins. One is above the wiring, one on top and one on the back side. Do this on both sides of the vehicle. The plastic piece and the shroud will not be reinstalled.



BX1839  
2006 Infinity G35  
Installation Instructions



6. To remove middle belly pan, remove 8 bolts using a 10MM socket and a push pin with a flat screwdriver. There are 4 bolts on each side with the push pin (grey arrow) in the middle. Do to both sides. Set bolts and push pin aside for later reinstallation.



7. With a Phillips Screw Driver remove the plastic push pin from washer reservoir spout. Set aside for later reinstallation.
8. To remove the windshield washer, you need to reach around behind the lower cross member with a 10MM wrench to remove the 2 hex nuts from the washer reservoir. Pull reservoir straight out to the side. Do this on the passenger side only. Disconnect all electrical and fluid lines. Set aside hex nuts and reservoir for later reinstallation.

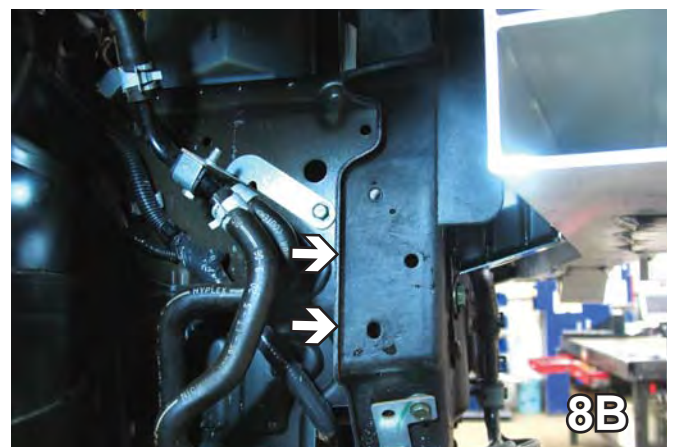
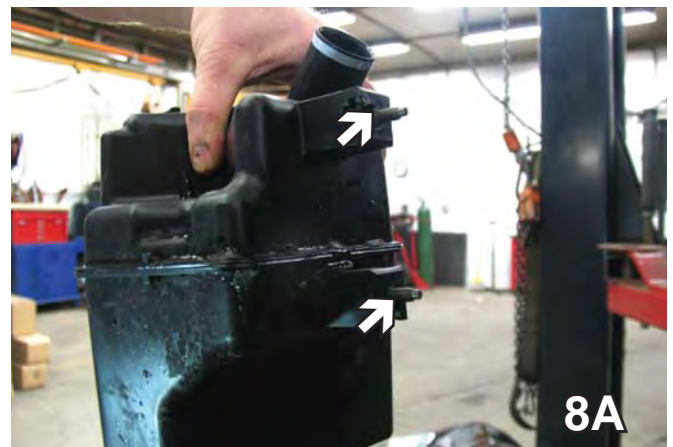

BX1839  
2006 Infinity G35  
Installation Instructions



9. Remove the air baffle on the drivers side by removing two bolts using a 10MM Socket. This will all be reinstalled in the same place later.

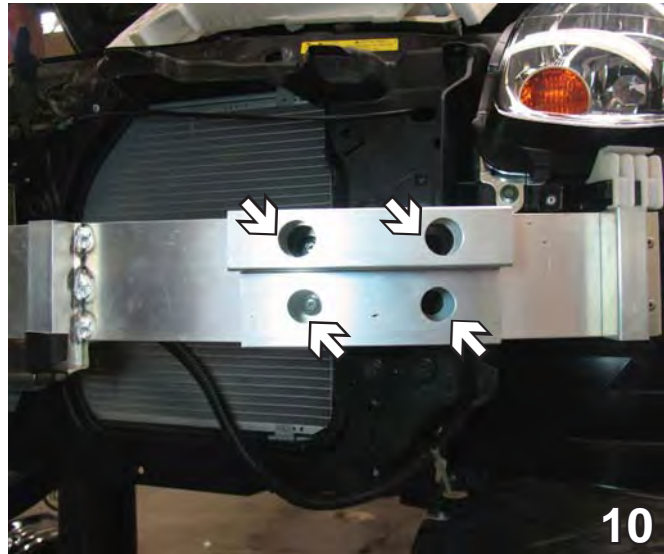

10. To remove the aluminum bumper, remove 4 bolts (two on top, two on bottom) using a 12MM socket. Do this to both sides. Pull bumper forward. Set aside bumper and bolts for later reinstallation.

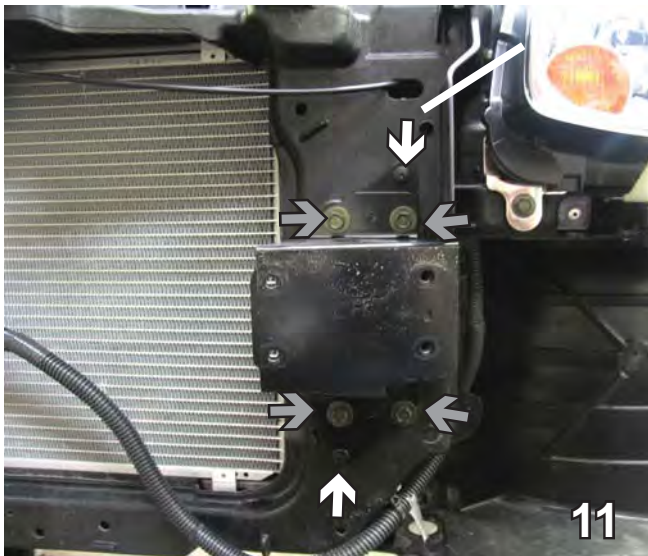

11. Remove bumper bracket, using a Phillips Screwdriver remove the 2 push pins (white arrows). Using a 12 MM Socket, remove 4 bolts (grey arrows). Do this on both sides. Save for later reinstallation.



12. Using a reciprocating saw, cut and remove marked area as depicted in steps 13 and 14. Do to both sides of the vehicle.

BX1839  
 2006 Infinity G35  
 Installation Instructions

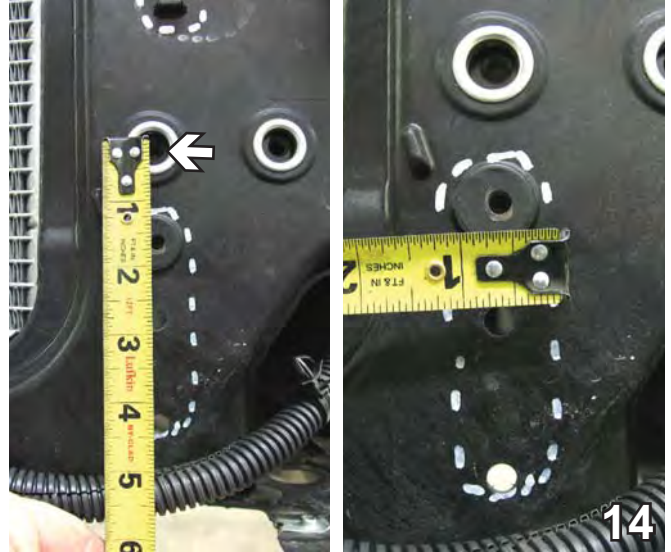
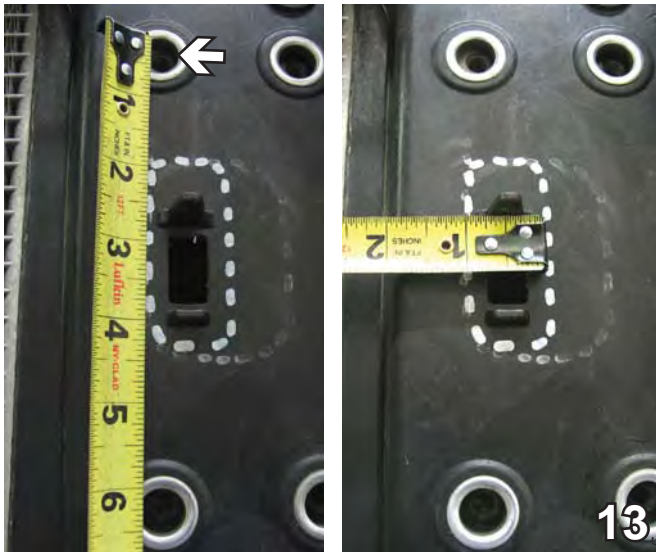
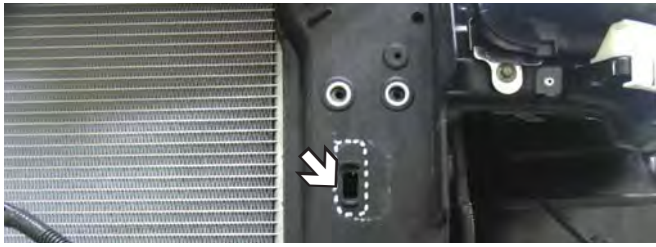

13. Right in front, after bumper brackets are removed, make slit as shown. From the center of the hole, go 1 3/4" down, make a slit to 4 1/4" by 1" wide. There is a little bracket at the end of the frame follow that around. This is done on both sides.

14. On the bottom make a second long slice, 1" wide by 3 3/8" long, around the corner down to the bottom of the third hole. Do this to both sides.

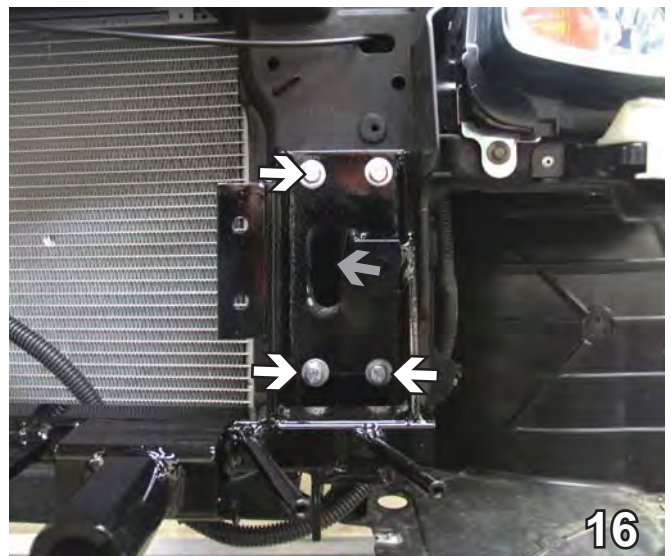

15. To start base plate installation, hold base plate to align with bumper bracket holes, start one bolt on each side. Use 8MM hex bolts and 5/16" flat and lock washers.

16. Insert the additional 8MM hex bolts, use Loctite Red and tighten according to specs. Do to both sides.

BX1839  
2006 Infinity G35  
Installation Instructions

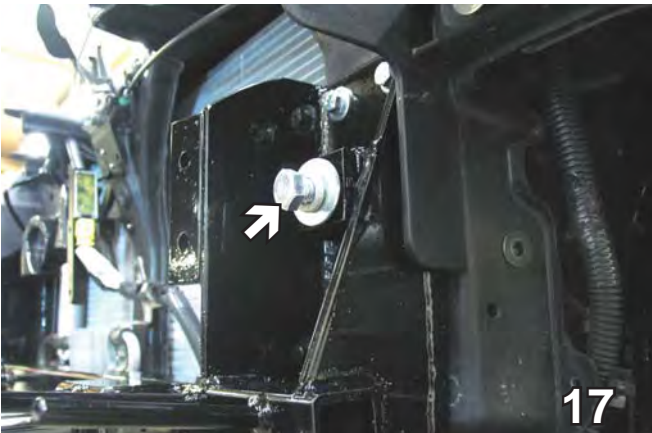

17. Slide upper bracket into hole in base plate (see grey arrow on step 16) and start 1/2"-13 x 1 1/2" Hex bolt with lock and flat washer on front side.



18. Align the upper bracket with existing hole in frame, then start 1/2"-13 x 1 1/2" Hex bolt with lock and flat washers. Tighten front bolt first and then the back bolt with Loctite Red. Do this to both sides.

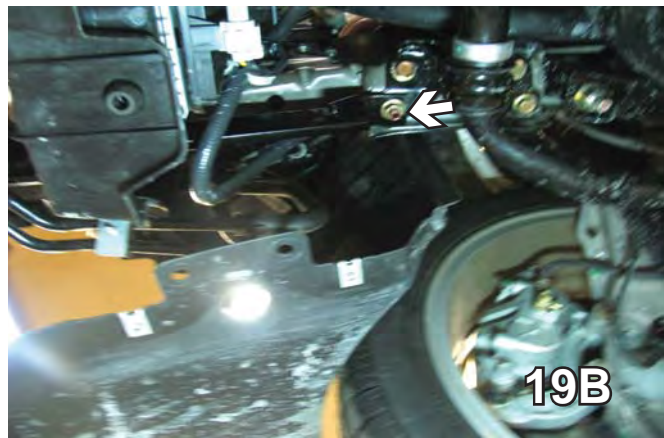
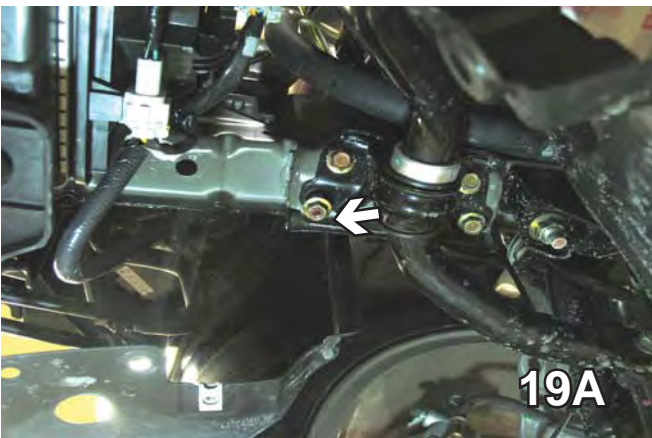

19. On the sway bar, passenger side, remove the front outside hex nut with a 14 MM socket. Install lower bracket following diagram on page 2. Use 1/2"-13 x 1 1/2" hex bolts with flat and lock washers and hex nuts, tighten with Loctite Red.

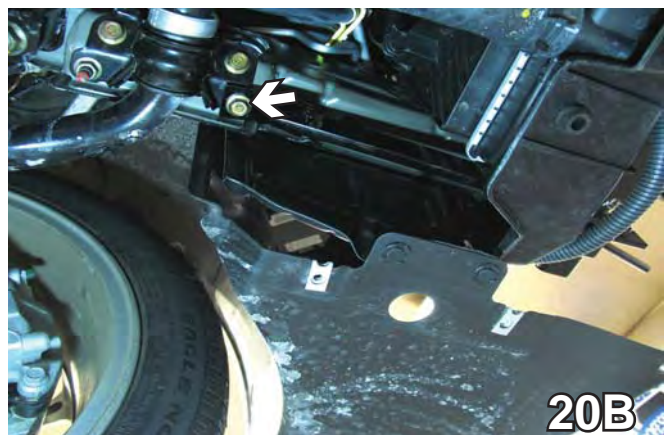
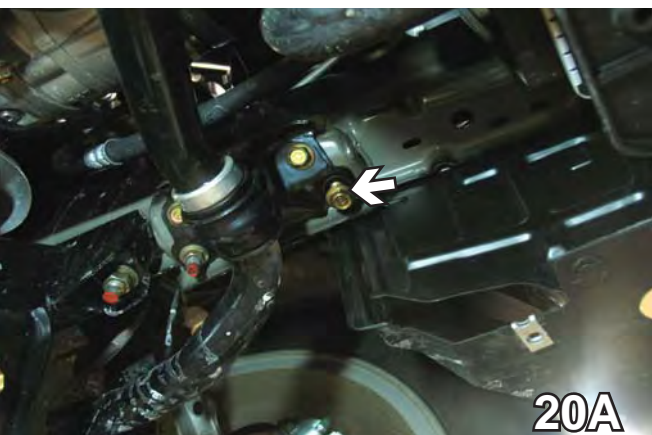

20. On the drivers side, remove the bolt. Install lower bracket following diagram on page 2. Use 1/2"-13 x 1 1/2" hex bolt with lock and flat washers, tighten with Loctite Red.



BX1839  
2006 Infinity G35  
Installation Instructions

**BE SURE TO USE LOCTITE® RED ON ALL BOLTS BEFORE TIGHTENING. TIGHTEN ALL BOLTS ACCORDING TO THE TORQUE CHART ON THE FRONT PAGE OF THESE INSTRUCTIONS OR ON PAGE 3 OF THE BASEPLATE TOWING GENERAL INSTRUCTIONS.**

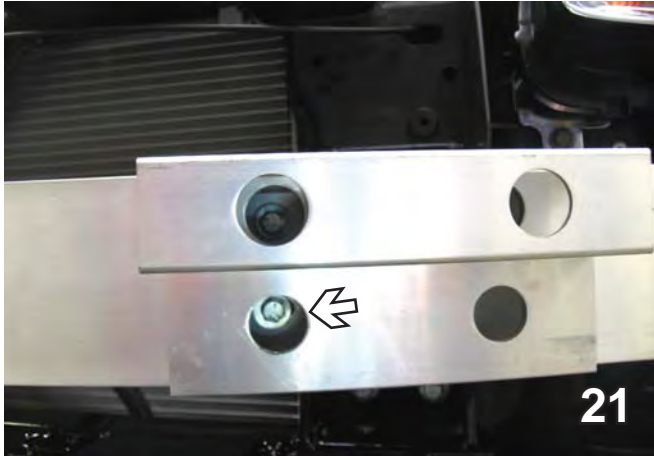

21. Use the inside holes to bolt the aluminum bumper back on. Use 5/16-18 x 1 1/4" Hex bolt with a flat and lock washer on the front. On the back use 5/16-18 whiz nuts. Do this on both sides.
22. Reinstall washer reservoir on passenger's side and an air baffle on driver's side.



23. Attach baseplate safety cables as in above photo or as close as possible. If you are unable to place safety cables in this position, position the cables around a solid piece of the frame. 226-0046 baseplate safety cables and 229-0359 quick links are recommended.

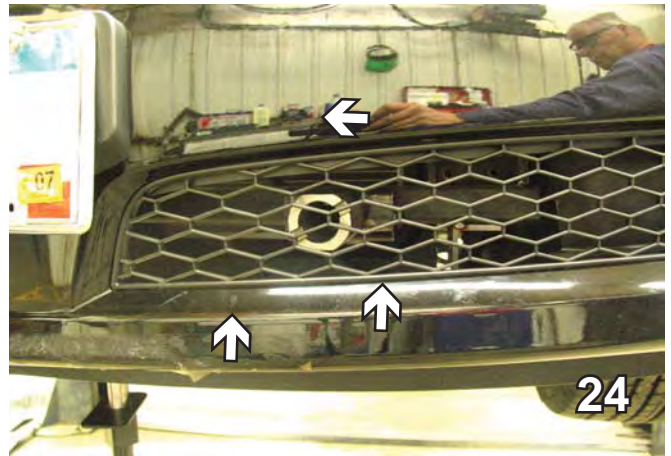

24. Hold fascia as close to its original position as possible, trim as necessary on both sides with the diagonal cutters. Reinstall fascia.

# BX1839

## 2006 Infinity G35

### Installation Instructions

Install the tow bar and safety cables according to the instructions provided in their packages. When demonstrating this to the customer, be sure to include all the contents and packages.

Do **NOT** substitute other devices if the tow bar pins and clips are misplaced.

**DEALER or INSTALLER:**  
Be certain the user receives the instruction sheets for their products.



Shown without removable tabs installed.



Shown with removable tabs installed.

Be sure that **ALL** electrical connections are plugged in properly and functioning **BEFORE** installing the fascia.

## Customer Service Commitment

Blue Ox® is focused on providing exemplary customer service, as observed in our mission statement and guiding principles. In accordance with this objective, Blue Ox® is proud to provide services such as repairs and general maintenance of Blue Ox® products at over 150 RV Rallies. Look for our Destination America or Blue Ox® Racing service crews at the next rally or race that you attend. If you were not present, you will find an informative, personalized note explaining any services that may have been performed to your Blue Ox® products.

Blue Ox® also offers educational seminars at rallies and through our Park and Resort teams. In addition, Blue Ox® customers visiting our factory may take advantage of the well-equipped Blue Ox® RV park at no charge to you, our valued and appreciated customer.

