



BX1842

2008-12 Nissan Infinity G37S

Installation Instructions

Serial Number

Please read BOTH these Installation Instructions and the General Towing Instructions before attempting to install or operate this equipment.

1. Blue Ox® towing products and accessories are intended to be installed by Blue Ox® Dealers who are familiar with our products and have the equipment and knowledge to do “fit work.” When necessary, Blue Ox® Dealers can be found at www.blueox.com or by contacting our 24/7 Customer Care Department at (888) 425-5382.

2. Many Blue Ox® Baseplates are designed to use existing holes and hardware to mount the baseplate to the towed vehicle. Even though bolts are there, do not assume they are adequate for baseplate mounting. Always use hardware supplied in the hardware kit or existing hardware specified in the Baseplate Towing Installation Instructions.

Attachment Tab Height: 15”
Attachment Tab Width: 25”

Bolt Torque Specifications		
Torque in Foot-Pounds per Metric Bolts		
Bolt Size	Grade 8.8	Grade 10.9
6MM	6	8
8MM	16	22
10MM	31	40
12MM	54	70
14MM	89	117



If the front of your vehicle looks different than this, please contact us at (402)385-3051.

Bolt Torque Specifications		
Torque in Foot-Pounds per Inch Bolts		
Bolt Size	Grade 5	Grade 8
1/4”	10	14
5/16”	19	29
3/8”	33	47
7/16”	54	78
1/2”	78	119
5/8”	154	230

Reference your vehicle owner’s manual for manufacturer’s towing specifications.

WARNING

Failure to read and follow these instructions could result in separation of the towed vehicle from the tow bar, causing property damage, loss of towed vehicle, personal injury or death.

BX1842
2008-12 Nissan Infinity G37S
Installation Instructions

Parts List

Ref. No.	Qty.	Part #	Description
1	6	61-5208	3/8"-16 Nut Plate with 14" Wire
2	1	61-6501	BX1842 Baseplate
3	2	62-3469	Attachment Tab
4	2	101-5822	4 Way Connector Adapter
5	1	102-7056	Breakaway Bracket
6	1	201-0050	1/4"-20 x 3/4" Hex Head Bolt, Grade 5, ZP
7	2	201-0192	#10-32 1/2" Slotted Round Head Screw
8	6	201-0440	3/8"-16 x 1-1/2" Hex Head Bolt, Grade 5, ZP
9	2	201-0553	1/4"-20 x 1/2" Hex Wshd. Type F TCS Screw, ZP
10	1	201-0654	#10-16 x 1" Self Tapping Screw, ZP
11	2	202-0047	#10-32 Hex Nut
12	1	202-0102	1/4"-20 Hex Nylon Nut, ZP
13	6	203-0010	3/8" Lock Washer, ZP
14	2	203-0054	#10 Lock Washer
15	2	226-0046 (not shown)	Class III Safety Cables
16	2	229-0359 (not shown)	3/8" Quicklink, ZP
17	1	293-1339 (not provided)	Breakaway Switch
18	1	294-0805 (not provided)	4 Pin Connector
19	1	294-0902 (not provided)	6 Pin Connector

Tools Required

Loctite® RED
Flat Screwdriver
9/16" Socket
10MM Socket
12MM Socket
13/32" Drill Bit
Utility Knife
1-1/4" Hole Saw
Large Vise Grip

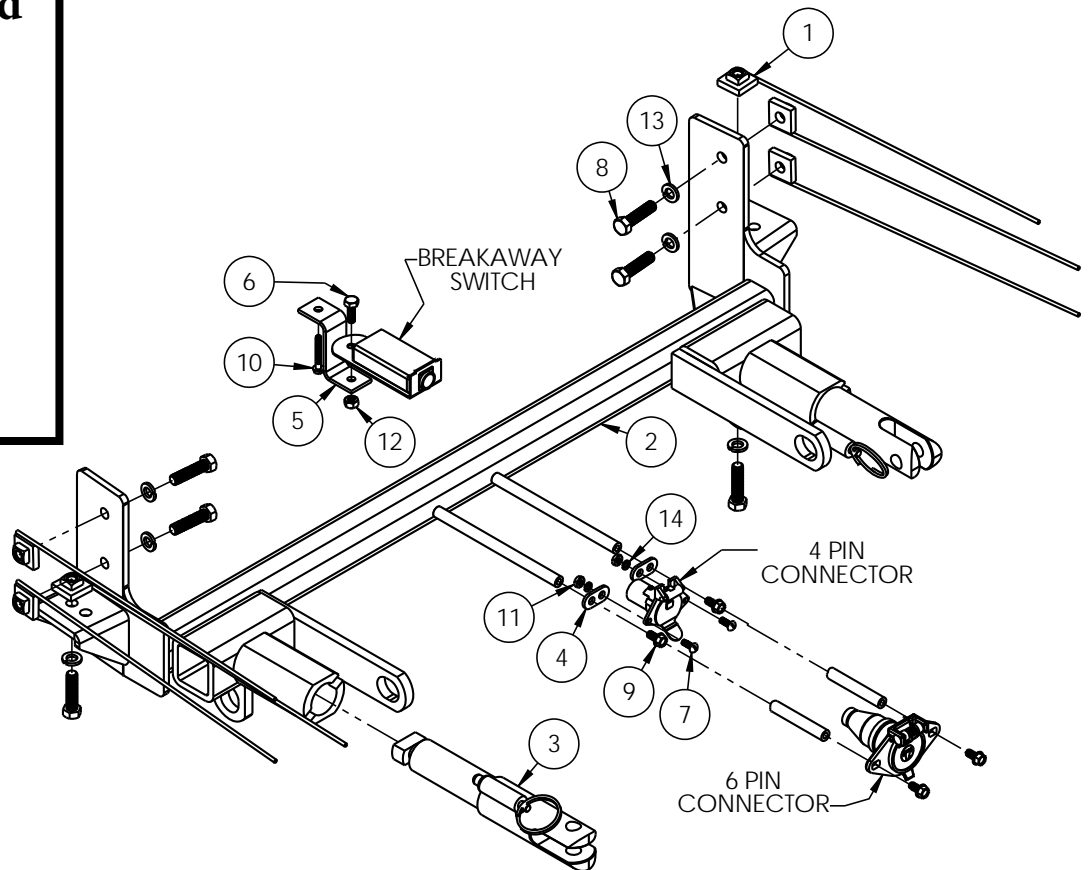

Important:

Use only genuine factory replacement parts on your baseplate. Do **NOT** substitute homemade or non-typical parts. If a bolt is lost or in need of replacement, for your safety and the preservation of your baseplate, be sure to use a replacement bolt of the same grade (In most cases it will be Grade 5, please reference the parts list above). Replacement parts may be ordered through your nearest Blue Ox® Dealer or Distributor.

BX1842
2008-12 Nissan Infinity G37S
Installation Instructions

Vehicle Weight

The weight of this vehicle is near the Class III, 5,000 lb. rating limitations. Some models, depending on options, may well exceed this 5,000 lb rating. Be sure to confirm the weight of your individual vehicle before towing. As of 1999 the Aventa® II is now 10,000 lbs. and either the Aventa® II or the Aventa® LX tow bar must be used for these applications.

Tow Bar Adapters are NOT to be used with vehicles weighing over 5,000 lbs.

Installation Notes

The fascia, bumper, bolts and push pins are removed and reinstalled

The dimensional variations between otherwise identical vehicles can be considerable. While the baseplate was designed for easy installation, it may be necessary to tailor the baseplate slightly to compensate for auto manufacturer's tolerances. These minor adjustments may include filing a hole slightly, bending electrical rods and/ or bending end plates.

The BX8848 Diode Wiring Kit is recommended for this vehicle.

Installation Instructions

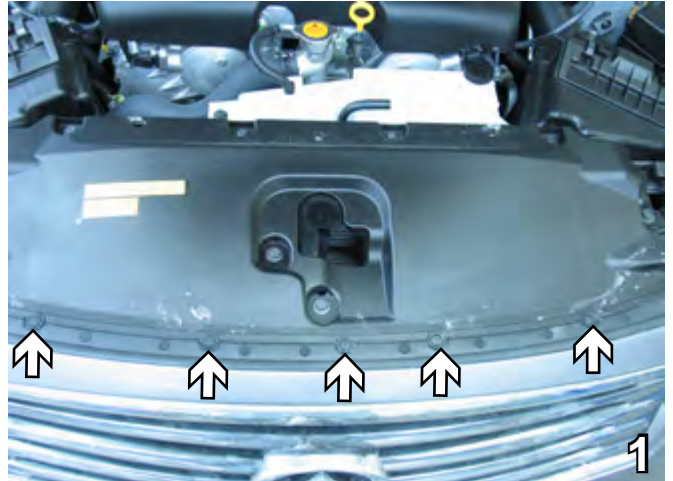

1. Using a flat screwdriver, remove seven (7) push pins from the flat plastic piece on top of fascia. Set push pins aside to be reinstalled later.



2. Pull back cover on the top above the front tire. Use a 10MM socket to remove the bolt. Do this to both sides of the vehicle. Set bolt aside to be reinstalled later.

BX1842
2008-12 Nissan Infinity G37S
Installation Instructions



3. Underneath the fascia remove the ten (10) bolts all the way across the bottom (driver's side shown) using a 10MM socket. Set bolts aside for later reinstallation.



4. Using a 10MM socket remove three (3) more bolts underneath the fascia in front of the tire. Do this on both sides. Set both aside for later reinstallation.



5. In the wheel well, just forward the front tire, remove one (1) push pin. Do this on both sides and set aside for later reinstallation.



6. Pry out the wheel well cover. Use a 10MM socket to remove bolt forward of the front tire. Do this to both sides of the vehicle. Set bolt aside to be reinstalled later. Pull the fascia corners out to the side of the vehicle, both sides, then pull fascia forward and carefully set aside for later reinstallation.

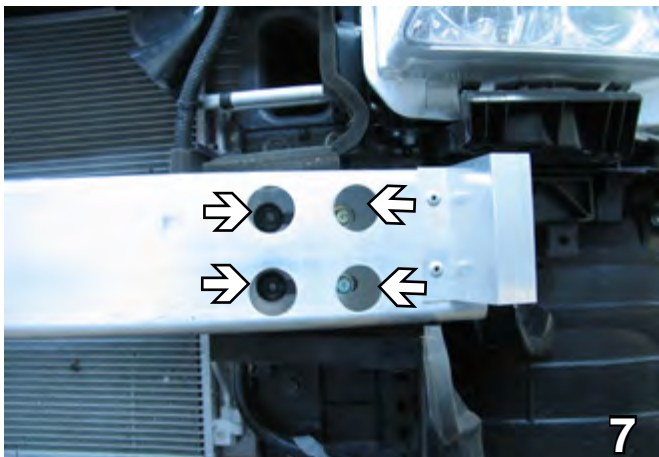

7. To remove the aluminum bumper, remove four (4) bolts, two (2) on the top and two (2) on the bottom using a 12MM socket. Do this to both sides. Unfasten all clips. Pull bumper forward. Set aside bumper and bolts for later reinstallation.

BX1842
2008-12 Nissan Infinity G37S
Installation Instructions

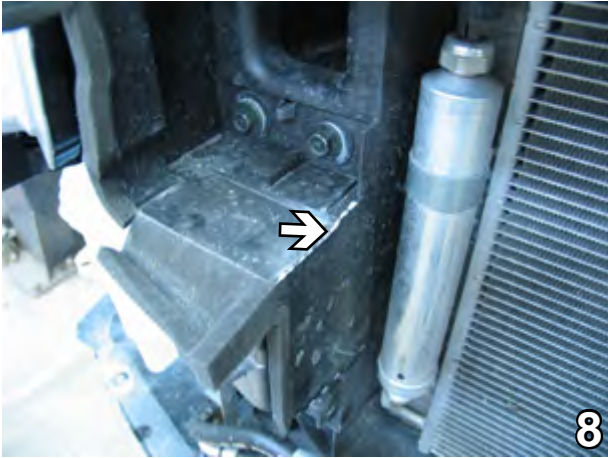

8. On the driver's side, unsnap the plastic cover. On the passenger side, use the utility knife to cut across the top and remove the plastic cover.

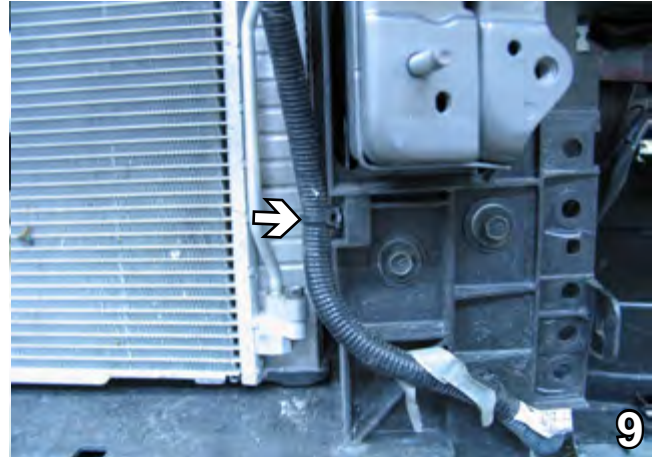

9. On the driver's side, pull the clip holding the hose to loosen it.

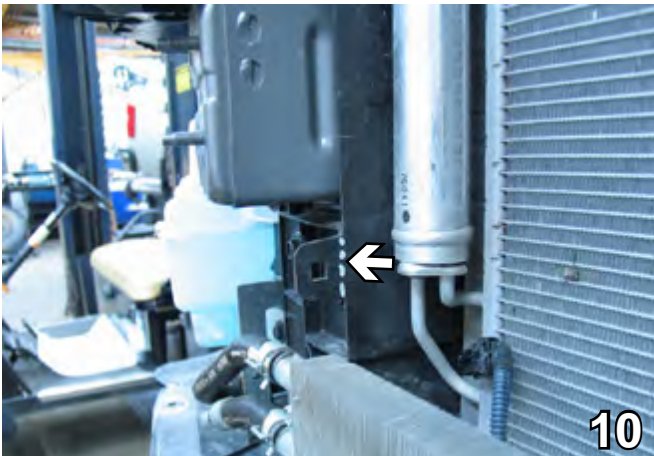

10. On the passenger side, with a utility knife trim off the plastic tab.

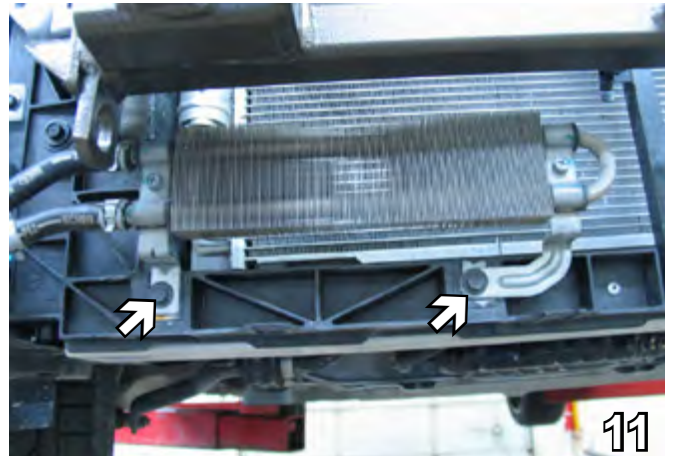

11. On the passenger side, using a 10MM socket remove the two bolts on the bottom of the radiator in order to swing it down and get it out of the way.

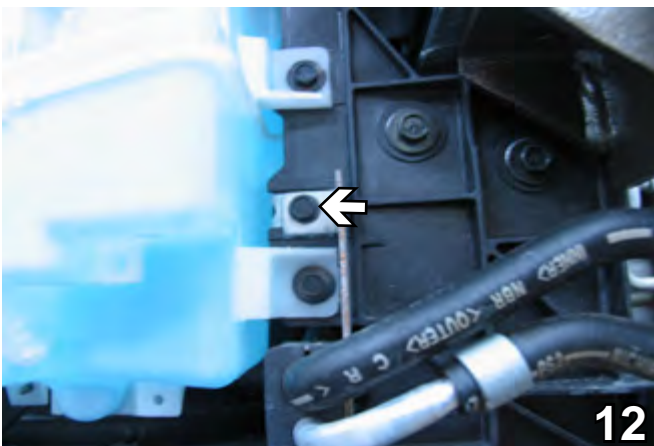

12. On the passenger side, using a 10MM socket remove the center bolt holding the washer reservoir.

BX1842
2008-12 Nissan Infinity G37S
Installation Instructions

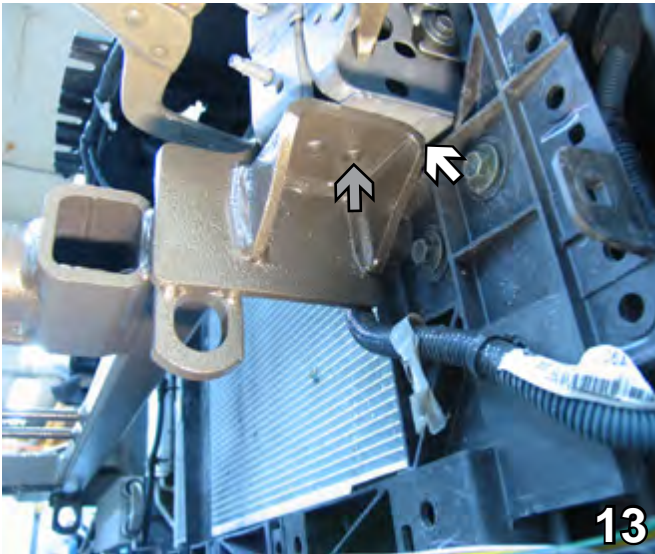

13. To install the baseplate raise up as high as possible until it hits the bottom of the bracket and as far back as it will go. Be sure it is level and clamp. Do this on both sides.

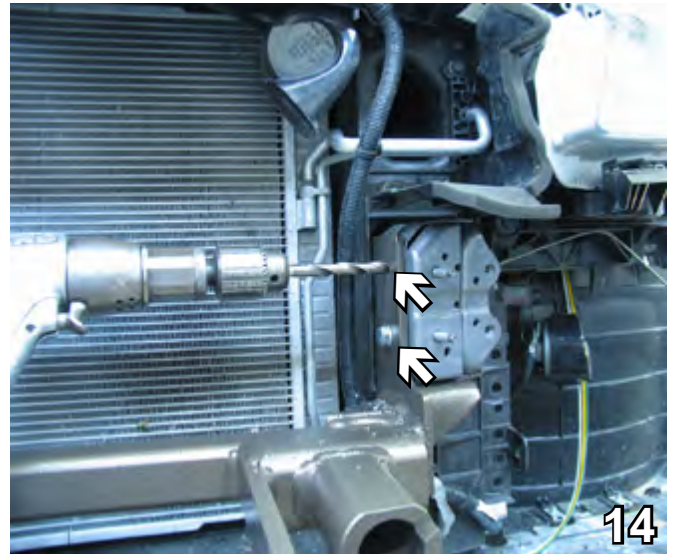

14. Using the baseplate as a template drill two holes into the side of the frame with the 13/32" drill bit. Do this on both sides.

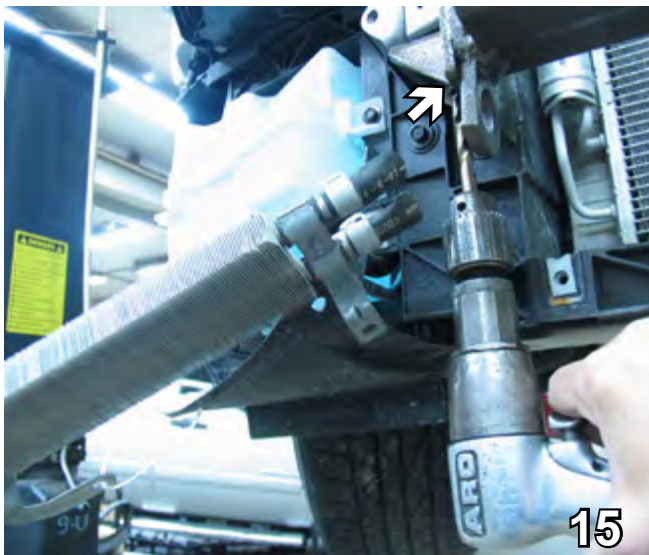

15. Also using the 13/32" drill bit, drill the back hole on the bottom of the plate (see gray arrow on #13). Do this on both sides.

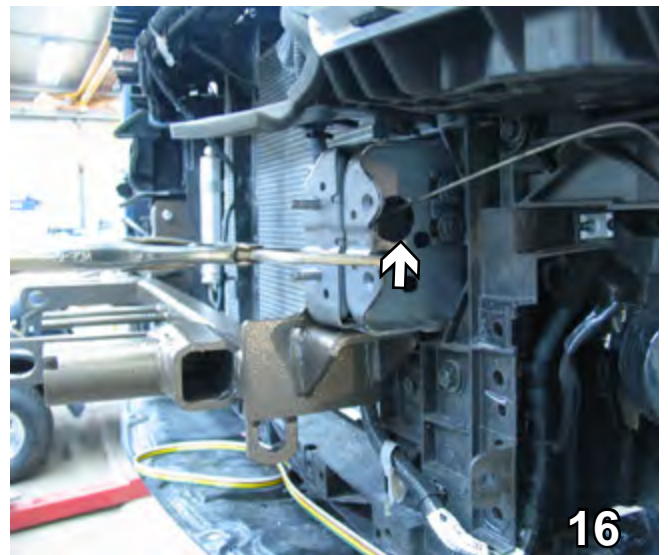

16. Use the 1 1/4" hole saw to drill the hole on the back side in order to insert the 61-5208s. Do this on both sides.

BX1842
2008-12 Nissan Infinity G37S
Installation Instructions

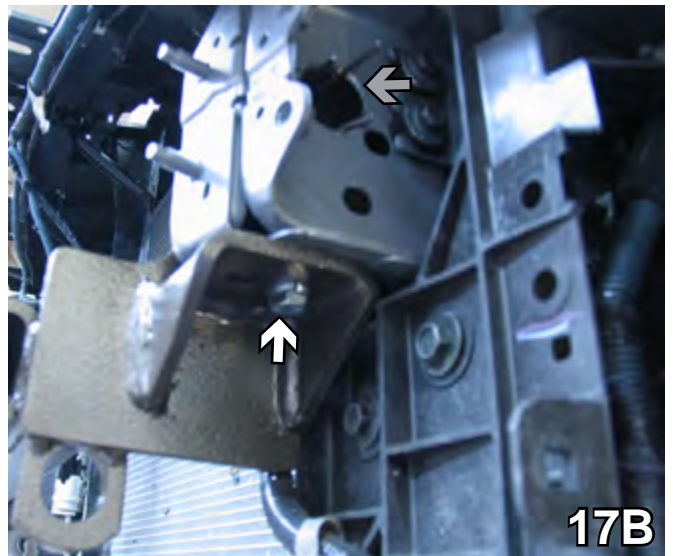
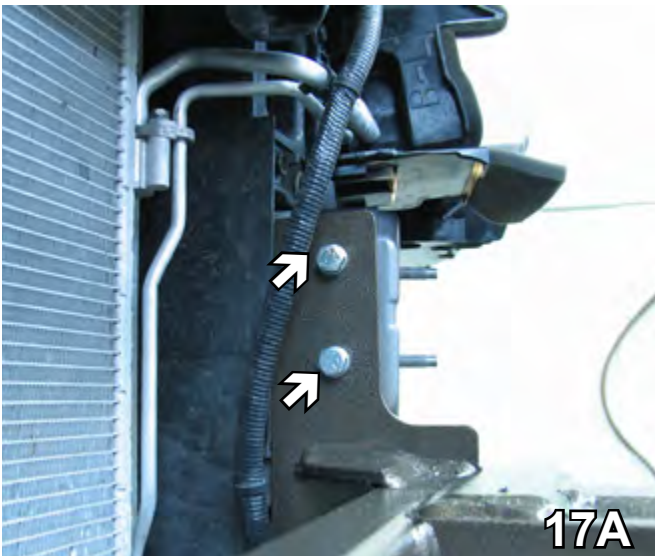

17. Install into the three drilled holes, two on the side and one on the bottom, 3/8-16 x 1 1/2" hex bolts and 3/8" lock washers with 61-5208 nut plates inserted into the frame end (photo 17B, gray arrow). Use Loctite Red on all the bolts and tighten. Do to both sides of the vehicle.

BE SURE TO USE LOCTITE® RED ON ALL BOLTS BEFORE TIGHTENING. TIGHTEN ALL BOLTS ACCORDING TO THE TORQUE CHART ON THE FRONT PAGE OF THESE INSTRUCTIONS OR ON PAGE 3 OF THE BASEPLATE TOWING GENERAL INSTRUCTIONS.

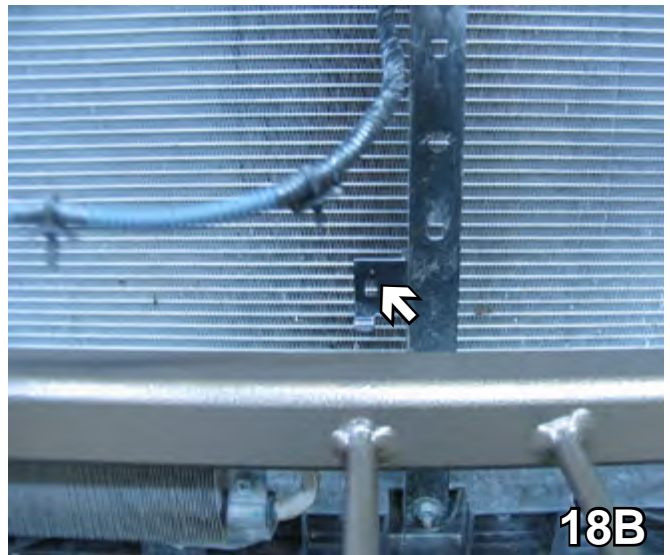

18. Pop off the plastic piece from the back of the bumper (photo 18A). Mount it to the bracket shown in photo 18B.

BX1842
2008-12 Nissan Infinity G37S
Installation Instructions



19. Attach baseplate safety cables as in above photo or as close as possible. If you are unable to place safety cables in this position, position the cables around a solid piece of the frame. 226-0047 baseplate safety cables and 229-0359 quick links are recommended.
20. Reattach the radiator and reinstall the bumper.
21. Reinstall the fascia.
22. Install the tow bar and safety cables according to the instructions provided in their packages.
23. Do **NOT** substitute other devices if the tow bar pins and clips are misplaced.



DEALER or INSTALLER:
Be certain the user receives the instruction sheets for their products.

Be sure that **ALL** electrical connections are plugged in properly and functioning **BEFORE** installing the fascia.

BX1842
2008-12 Nissan Infinity G37S
Installation Instructions

Customer Service Commitment

Blue Ox® is focused on providing exemplary customer service, as observed in our mission statement and guiding principles. In accordance with this objective, Blue Ox® is proud to provide services such as repairs and general maintenance of Blue Ox® products at over 150 RV Rallies. Look for our Destination America or Blue Ox® Racing service crews at the next rally or race that you attend. If you were not present, you will find an informative, personalized note explaining any services that may have been performed to your Blue Ox® products.

Blue Ox® also offers educational seminars at rallies and through our Park and Resort teams. In addition, Blue Ox® customers visiting our factory may take advantage of the well-equipped Blue Ox® RV park at no charge to you, our valued and appreciated customer.