



Baseplate Installation Instructions

BX1980

2008-10 Chrysler Town & Country
2008-10 Dodge Caravan
Installation Instructions

Serial Number

Please read BOTH these Installation Instructions and the General Towing Instructions before attempting to install or operate this equipment.

- Blue Ox® towing products and accessories are intended to be installed by Blue Ox® Dealers who are familiar with our products and have the equipment and knowledge to do “fit work.” When necessary, Blue Ox® Dealers can be found at www.blueox.com or by contacting our Customer Care Department at (402) 385-3051.
- Many Blue Ox® Baseplates are designed to use existing holes and hardware to mount the baseplate to the towed vehicle. Even though bolts are there, do not assume they are adequate for baseplate mounting. Always use hardware supplied in the hardware kit or existing hardware specified in the Baseplate Towing Installation Instructions.

Attachment Tab Height: 13”
Attachment Tab Width: 17”

Bolt Torque Specifications
Torque in Foot-Pounds for Metric Bolts

Bolt Size	Grade 8.8	Grade 10.9
6MM	6	8
8MM	16	22
10MM	31	40
12MM	54	70
14MM	89	117

Confirm the towability and pre-towing procedures for your vehicle with the owner’s manual or contact the vehicle’s manufacturer for specific towing procedures.

Bolt Torque Specifications
Torque in Foot-Pounds for Inch Bolts

Bolt Size	Grade 5	Grade 8
1/4”	10	14
5/16”	19	29
3/8”	33	47
7/16”	54	78
1/2”	78	119
5/8”	154	230



If the front of your vehicle looks different than this, call us at (402) 385-3051.

! WARNING

Failure to read and follow these instructions could result in separation of the towed vehicle from the tow bar, causing property damage, loss of towed vehicle, personal injury or death.

BX1980
2008-10 Chrysler Town & Country
2008-10 Dodge Caravan
Installation Instructions

Parts List

Ref. No.	Qty.	Part #	Description
1	1	61-6465	WLDM'T, BASEPLATE, BX1980
2	12	201-0368	3/8-16 X 1 1/4 HEX HEAD BOLT,GRD. 5
3	12	203-0010	3/8 LOCK WASHER, ZP
4	12	202-0003	3/8-16 HEX NUT, ZP
5	2	201-0553	1/4-20 X 1/2 HX.WSHD.TYPE F TCS, ZP
6	2	201-0192	10-32 X 1/2 SLOT, RD. HD. SCREW
7	2	203-0054	#10 LOCK WASHER
8	2	202-0047	#10-32 HEX NUT
9	2	101-5822	ADAPTER, 4 WAY CONNECTOR
10	2	62-3468	ATT TAB ASSY, REM, SF/SB, 1 HOLE
	2	226-0046	BASEPLATE SAFETY CABLE, 36" CL III (NOT SHOWN)
	2	290-0437	RECEIVER, CAP PLUG (BLK) (NOT SHOWN)
	2	229-0359	QUICKLINK, 3/8, ZP (NOT SHOWN)

Tools Required

- 10MM Socket
- 9/16" Socket
- T20 Torx
- Reciprocating Saw
- Flat Screwdriver
- Phillips Screwdriver
- Utility Knife
- Tape Measure
- 13/32" Drill Bit
- Loctite® RED

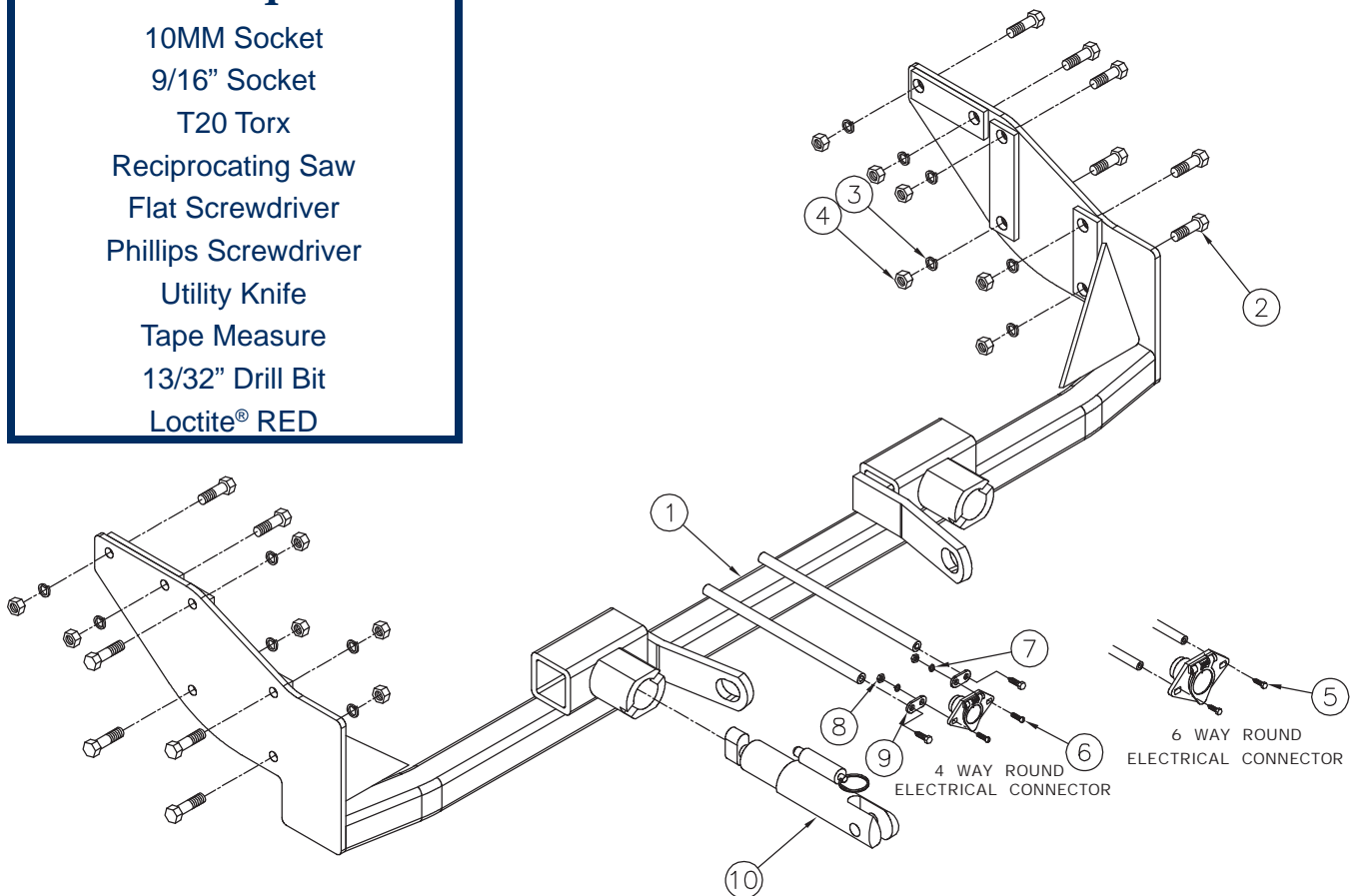

Important:

Use only genuine factory replacement parts on your baseplate. Do **NOT** substitute homemade or non-typical parts. If a bolt is lost or in need of replacement, for your safety and the preservation of your baseplate, be sure to use a replacement bolt of the same grade (In most cases it will be Grade 5, please reference the parts list above). Replacement parts may be ordered through your nearest Blue Ox® Dealer or Distributor. Failing to follow and/or altering these installation instructions in either installation or required equipment will void the manufacturer's warranty.

BX1980

2008-10 Chrysler Town & Country 2008-10 Dodge Caravan Installation Instructions

Vehicle Weight:

Motorhome mount tow bars are recommended for use with this baseplate. Due to the design of the removable tabs, the RangeFinderII and Ambassador tow bars can not be used. Adapters, except the BX8833 and BX88151, can not be used with this baseplate.

Installation Notes: The fascia is removed and reinstalled during installation of the baseplate. Drilling is required. Trimming of the fascia is required.

The dimensional variations between otherwise identical vehicles can be considerable. While the baseplate was designed for easy installation, it may be necessary to tailor the baseplate slightly to compensate for auto manufacturer's tolerances. These minor adjustments may include filing a hole slightly, bending electrical rods and/ or bending end plates.

The BX8869 Bulb and Socket Wiring Kit is recommended for this vehicle.



Installation Instructions:



1. Using a 10MM socket remove the bolt above the headlight. Using a flat screwdriver remove the push pin. Do this to both sides and set bolts and push pins aside for later reinstallation.



- 2a. Chrysler Town & Country:** Using a Phillips screwdriver, remove two push pins just forward of the front tire on the wheel well. Do this to both sides of the vehicle. Set push pins aside to be reinstalled later.
- 2b. Dodge Caravan:** Using a T20 Torx, remove two push pins just forward of the front tire on the wheel well. Do this to both sides of the vehicle. Set push pins aside to be reinstalled later.

BX1980
2008-10 Chrysler Town & Country
2008-10 Dodge Caravan
Installation Instructions

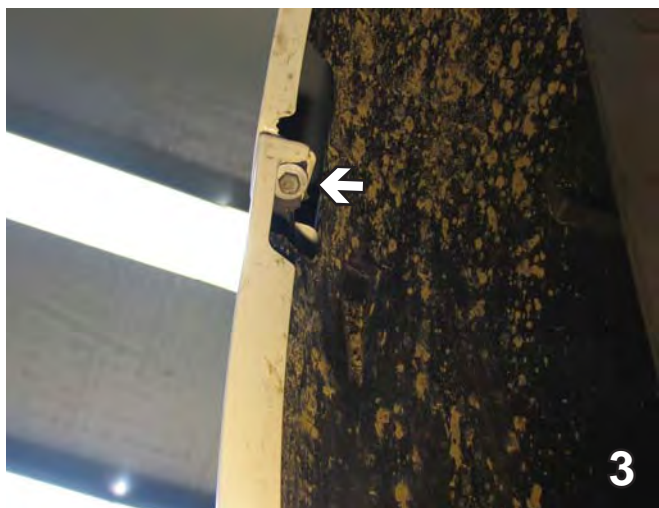

3. Continuing just forward of the front tire on the wheel well, using a 10MM socket, remove the bolt in the corner. Do to both sides and set bolt aside for later reinstallation.



4. On the driver side only, follow the fire wall around to the back, use a flat screwdriver to remove the push pin. Set the pin aside for later reinstallation.



5. Using a flat screwdriver, remove four push pins from underneath the front edge of the fascia. Set push pins aside to be reinstalled later. The corner of the fascia is then pulled out to the side and forward to remove. Set fascia aside carefully to be reinstalled later. Be sure to unplug the fog lights.

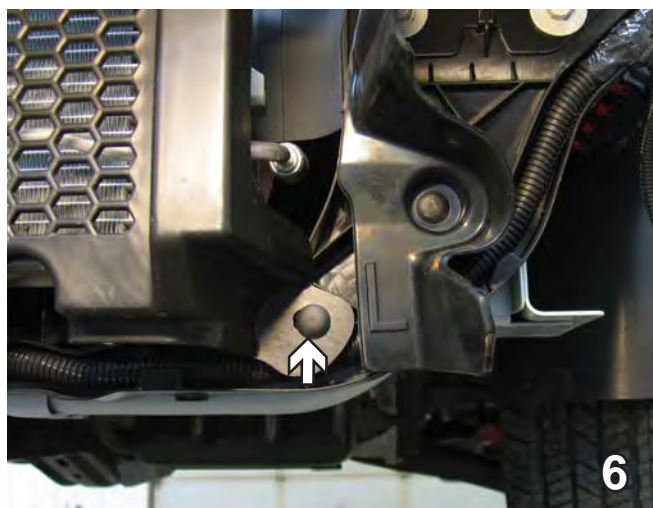

6. Using a flat screwdriver, remove the push pin on each side of the opening under the fascia.

BX1980

2008-10 Chrysler Town & Country 2008-10 Dodge Caravan Installation Instructions

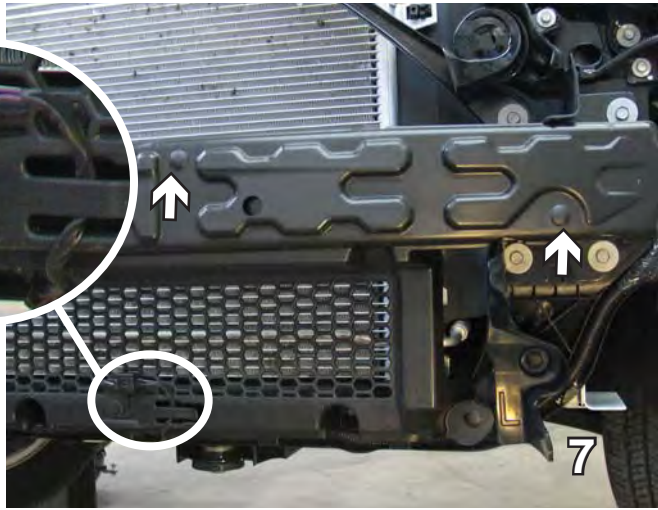

7. Using a flat screwdriver, remove the push pin from the air temperature control and let it hang (see arrow in inset). Continue removing four more push pins across the top. Remove the plastic cover.

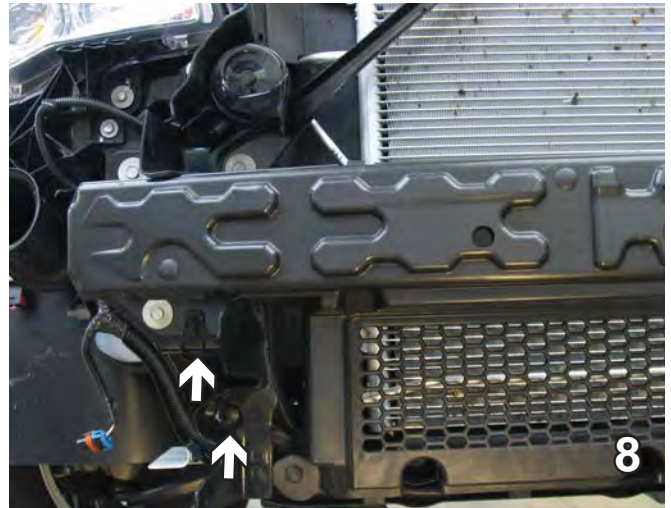

8. Using a flat screwdriver, remove the push pin. Then using a utility knife, cut the loose plastic right along the bumper. Do this to both sides.

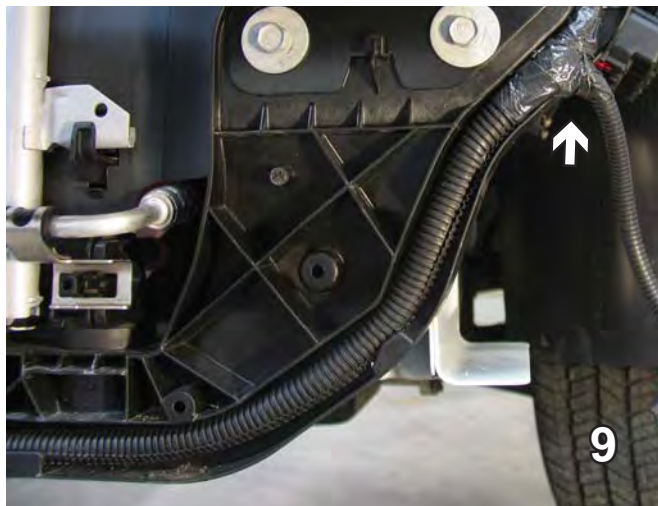

9. On the driver's side, pull out the push pin clip and take the wire harness out.



10. Using a utility knife, cut straight across right along side the bottom of the plate and straight up to a 90° angle. Do this on both sides.

BX1980
2008-10 Chrysler Town & Country
2008-10 Dodge Caravan
Installation Instructions

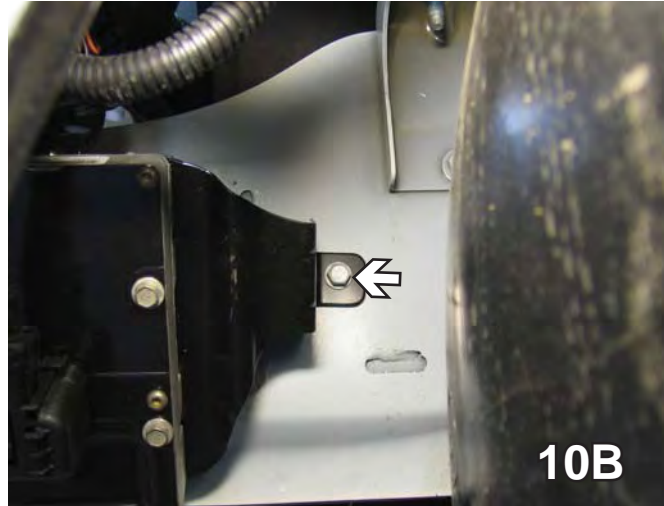
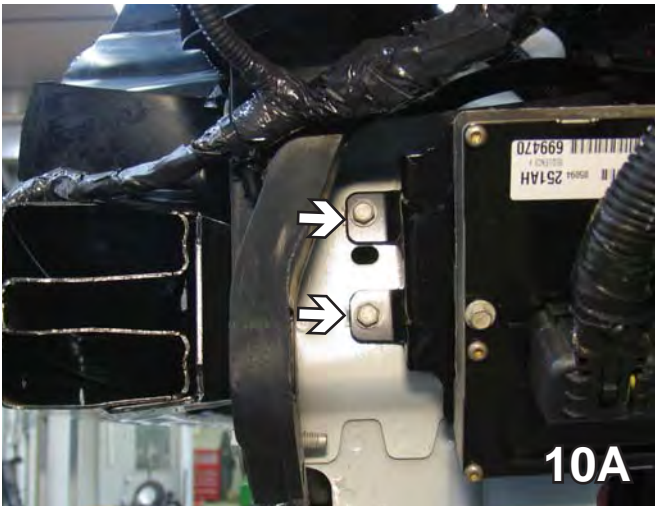

10. On the driver's side, using a 10MM socket remove two bolts on the front and one on the back then let the computer hang down in order to do drilling. Set bolts aside to be reinstalled later.

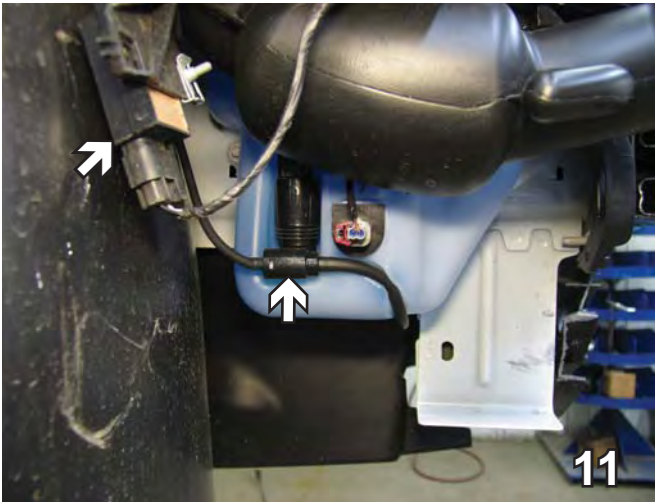

11. Unplug the electrical plug and take the water lines off the washer reservoir and plug them.



12. Using a 10MM socket, remove the two bolts one on each side of the washer reservoir. Set washer reservoir and bolts aside to be reinstalled later.

BX1980

2008-10 Chrysler Town & Country 2008-10 Dodge Caravan Installation Instructions

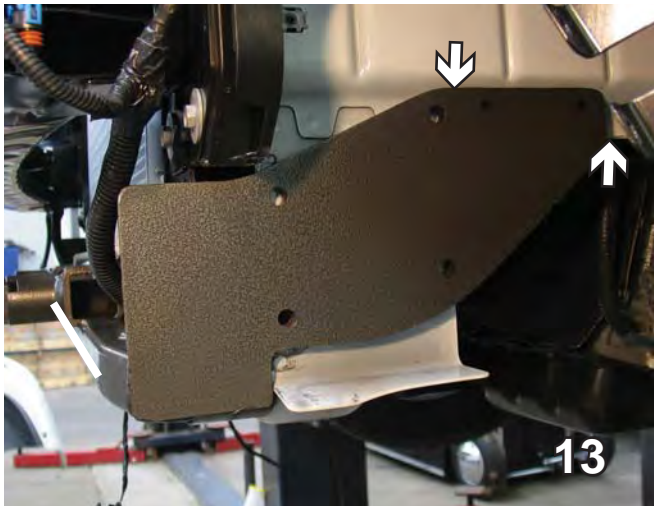

13. Slide the baseplate up where we cut and back as far as it will go. Be sure the baseplate is level.



14. There is 1/2" gap between the line and the baseplate.

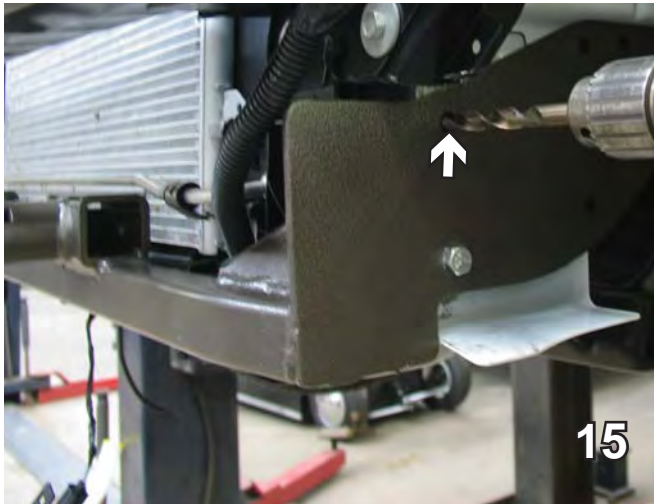

15. Using the baseplate as a template, drill six holes with a 13/32" drill bit.

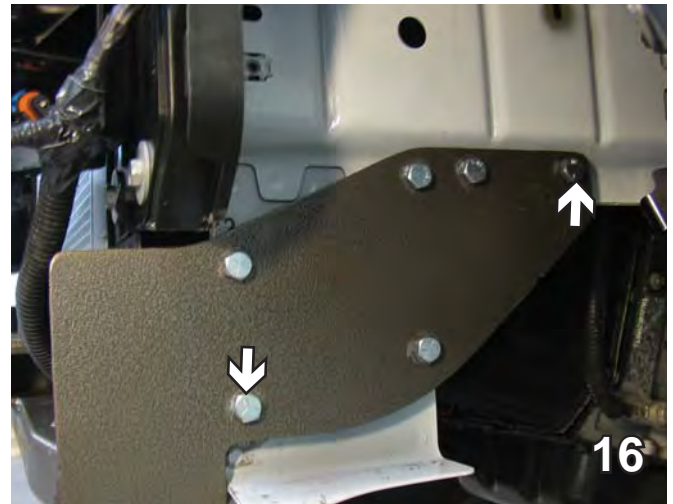

16. On the driver's side, mount the baseplate using 3/8" x 1 1/4" hex bolts going in and 3/8" lock washers and 3/8" hex nuts. Be sure to use LOCTITE Red on ALL bolts.

BE SURE TO USE LOCTITE® RED ON ALL BOLTS BEFORE TIGHTENING. TIGHTEN ALL BOLTS ACCORDING TO THE TORQUE CHART ON THE FRONT PAGE OF THESE INSTRUCTIONS OR ON PAGE 3 OF THE BASEPLATE TOWING GENERAL INSTRUCTIONS.

BX1980

2008-10 Chrysler Town & Country 2008-10 Dodge Caravan Installation Instructions

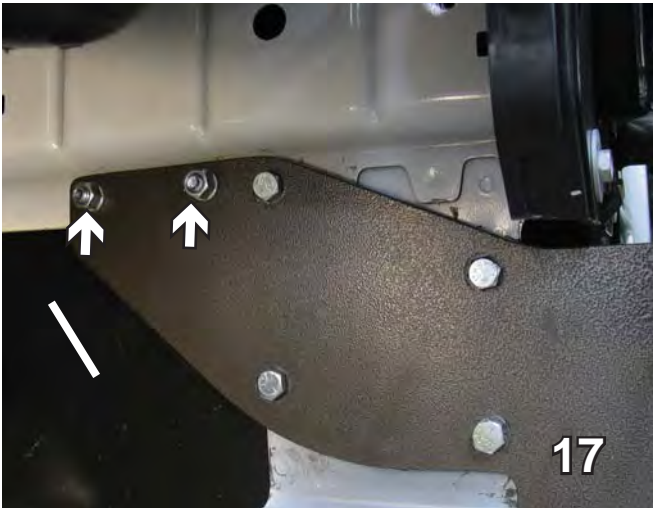

17. On the passenger's side, the top two bolts are brought from the inside out because of the black plastic shield. The same 3/8" x 1 1/4" hex bolts and 3/8" lock washers and 3/8" hex nuts are used. Be sure to use LOCTITE Red on ALL bolts.



18. Hold the plastic shield up to the front and with the utility knife cut out as needed for the baseplate tabs.



19. Using the utility knife cut 3" straight down on the corner of the plastic shield. Do this on both sides.

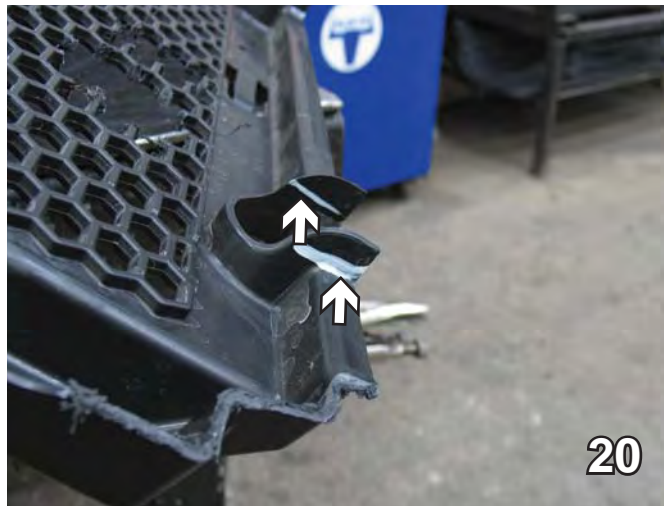

20. On the back side of the plastic shield, cut off the six tabs.

BX1980

2008-10 Chrysler Town & Country 2008-10 Dodge Caravan Installation Instructions

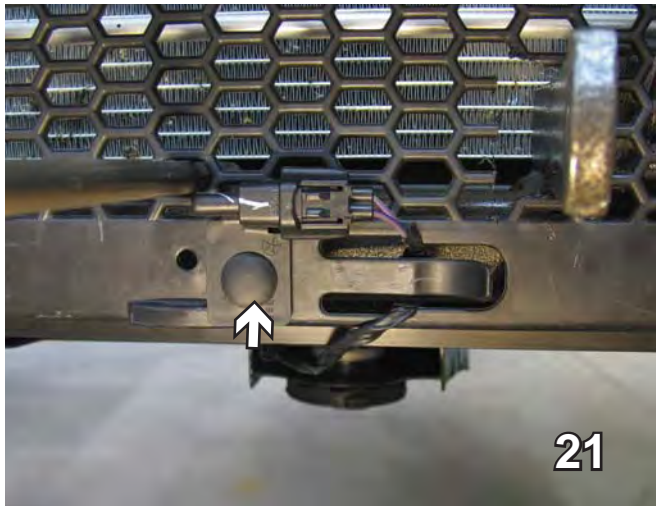

21. The air temperature control will not go back into the original hole. Hold it up and drill another hole.

Be sure that **ALL** electrical connections are plugged in properly and functioning **BEFORE** installing the fascia.

23. Replug the fog lights. Reinstall the fascia, computer and washer reservoir.



22. Attach the permanent baseplate safety cables to the provided convenience link on the baseplate (see grey arrow). The photo above shows the recommended installation of the cables to frame of vehicle (see white arrow). Additional options may interfere with suggested mounting; in this case secure the cables to a solid piece of the frame as described in the instructions included with the permanent baseplate safety cables. Be sure the safety cables do not rub against any hoses or moving parts. Do this to both sides of the vehicle.

BX1980

2008-10 Chrysler Town & Country 2008-10 Dodge Caravan Installation Instructions

Install the tow bar and safety cables according to the instructions provided in their packages. When demonstrating this to the customer, be sure to include all the contents and packages.

Do **NOT** substitute other devices if the tow bar pins and clips are misplaced.

DEALER or INSTALLER:
Be certain the user receives the instruction sheets for their products.



Shown with removable tabs installed.

If the baseplate is in an accident, it must be replaced. **DO NOT** use it again! An accident can cause unseen damage and using it again could result in more damage or serious injury. **DO NOT** use the baseplate if it is damaged or missing parts.

CUSTOMER SERVICE COMMITMENT

Blue Ox is committed to providing you with exceptional customer care throughout your lifetime with our products. Our team is here to assist you with any questions you may have regarding the performance of your product. Simply call 1-800-385-3051 and you can speak with our customer care team.

Additionally, please visit our website to see which rallies our Destination America team will be attending. For a nominal fee, our service technician will service your towing system to ensure it's in proper working condition. Also as a commitment to our customers, should you visit our factory you can stay at our full service Blue Ox campground at no charge along with enjoying a factory tour.

Again thank you for being our customer and for the confidence you have shown in the performance of our products. It is because of customers like you we enjoy the success we have today.



© 2007, 08, 09, 11 Blue Ox
One Mill Road, Industrial Park
Pender, Nebraska 68047
Phone: (402) 385-3051 • Fax: (402) 385-3360
www.blueox.com