

2008-10 Chrysler Sebring Convertible Installation Instructions

Serial Number

Please read **BOTH** these Installation Instructions and the General Instructions before attempting to install or operate this equipment.

- Blue Ox® towing products and accessories are intended to be installed by Blue Ox® Dealers who are familiar with our products and have the equipment necessary and knowledge to do "fit work". When necessary Blue Ox® Dealers can be found at www.blueox.com or by contacting our Customer Care Department at (402) 385-3051.
- Many Blue Ox® Baseplates are designed to use existing holes and hardware to mount the baseplate to the towed vehicle. Even though bolts are there, do not assume they are adequate for baseplate mounting. Always use hardware supplied in the hardware kit and existing hardware specified in the Baseplate Installation Instructions.

Attachment Tab Height: 32 3/4"

Attachment Tab Width: 18"

Bolt Torque Specifications

Torque in Foot-Pounds for Metric Bolts

Bolt Size	Grade 8.8	Grade 10.9
6MM	6	8
8MM	16	22
10MM	31	40
12MM	54	70
14MM	89	117

Confirm the towability and pre-towing procedures for your vehicle with the owner's manual or contact the vehicle's manufacturer for specific towing procedures.

Bolt Torque Specifications

Torque in Foot-Pounds for Inch Bolts

Bolt Size	Grade 5	Grade 8
1/4"	10	14
5/16"	19	29
3/8"	33	47
7/16"	54	78
1/2"	78	119
5/8"	154	230

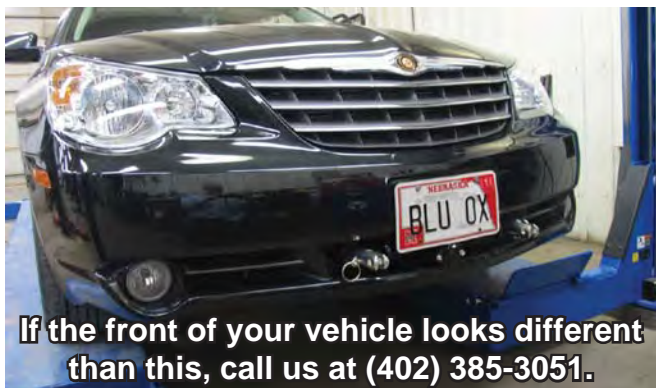

If the front of your vehicle looks different than this, call us at (402) 385-3051.

WARNING

Failure to read and follow these instructions could result in separation of the towed vehicle from the tow bar, causing property damage, loss of towed vehicle, personal injury or death.

BX1984

2008-10 Chrysler Sebring Convertible

Installation Instructions

Parts List

Ref. No.	Qty.	Part #	Description
1	1	61-6530	WLDM'T, BASEPLATE, BX1984
2	9	61-5208	WLDT, NUT PLT, 1/4X1X1, 3/8 BLT WIR
3	9	201-0368	3/8-16 X 1 1/4 HEX HEAD BOLT,GRD. 5
4	9	203-0010	3/8 LOCK WASHER, ZP
5	4	201-0418	8MM-1.25 X 35MM HEX BOLT GRD.8.8 ZP
6	1	201-0419	8MM-1.25 X 50MM HEX BOLT GRD.8.8 ZP
7	5	203-0102	8MM LOCK WASHER, ZP
8	1	107-1756	TUBE, 3/4 OD X 11GA X 1 INCH
9	2	107-1760	TUBE, 3/4 OD X 11 GA W X 3/4
10	4	107-1801	TUBE, 3/4 OD X 11GA X 1/2 INCH
11	1	201-0655	6MM-1.0 X 30MM HEX BOLT, GRD8.8,ZP
12	1	203-0161	6MM, LOCK WASHER, ZP
13	2	201-0553	1/4-20 X 1/2 HX.WSHD.TYPE F TCS, ZP
14	2	201-0192	10-32 X 1/2 SLOT, RD. HD. SCREW
15	2	203-0054	#10 LOCK WASHER
16	2	202-0047	#10-32 HEX NUT
17	2	101-5822	ADAPTER, 4 WAY CONNECTOR
18	2	62-3469	ATT TAB ASSY, REM, SF/LB, 1 HOLE
	2	226-0046	BASEPLATE SAFETY CABLE, 36" CL III (NS)
	2	229-0359	QUICKLINK, 3/8, ZP (Not Shown)
	2	290-0437	RECEIVER, CAP PLUG (BLK) (Not Shown)

Tools Required

- 7MM Socket
- 10MM Socket
- 13MM Socket
- 9/16" Socket
- 9/16" Wrench
- T25 Torx
- Large Vise Grips
- Reciprocating Saw
- 1 1/2" Hole Saw
- 13/32" Drill Bit
- Utility Knife
- Pliers
- LOCTITE Red

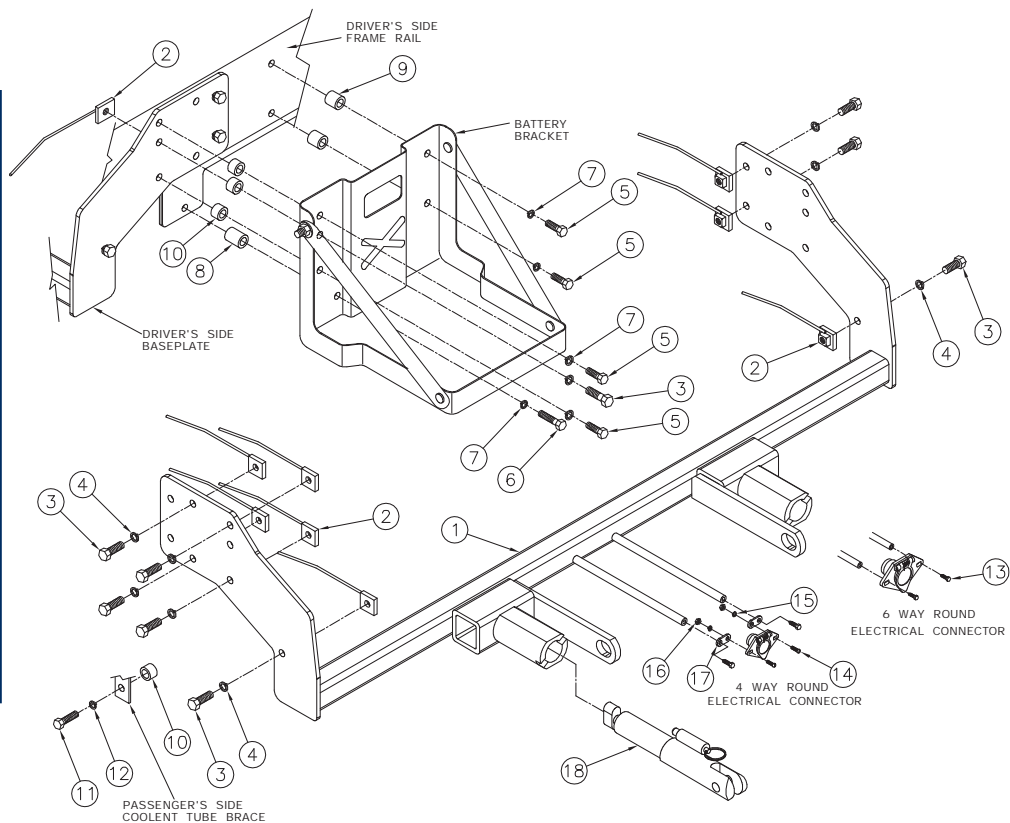

Important:

Use only genuine factory replacement parts on your baseplate. Do NOT substitute homemade or non-typical parts. If a bolt is lost or in need of replacement, for your safety and the preservation of your baseplate, be sure to use a replacement bolt of the same grade (In most cases it will be Grade 5, please reference the parts list above). Replacement parts may be ordered through your nearest Blue Ox® Dealer or Distributor, or call our Customer Care Team at (402)385-3051. Failing to follow and/or altering these installation instructions in either installation or required equipment will void the manufacturer's warranty. Towing behind a non-motorized vehicle will void the warranty.

BX1984

2008-10 Chrysler Sebring Convertible

Installation Instructions

Removable Tab:

Motorhome mount tow bars are recommended for use with this baseplate. Due to the design of the removable tabs, the RangeFinder II, Adventurer, and Ambassador tow bars can not be used. The Acclaim tow bar may be used, but will not fold and store on the front of the vehicle. Adapters, except the BX8833 and the BX88151, can not be used with this baseplate.

Instructions:

The grille, fascia, horn, headlight assembly, battery, washer reservoir, bumper, bolts and push pins are removed and reinstalled for the baseplate installation. Drilling is required. Trimming is required.

The dimensional variations between otherwise identical vehicles can be considerable. While the baseplate was designed for easy installation, it may be necessary to tailor the baseplate slightly to compensate for auto manufacturer's tolerances. These minor adjustments may include filing a hole slightly, bending electrical rods or bending end plates.

The BX8869, Bulb and Socket Wiring Kit is recommended for this vehicle.



Installation Instructions



1. Remove six push pins, three on each side and one in the middle (white arrow). With a 10MM socket remove the two metric bolts, one on each side (gray arrow). Lift the grille up, pull forward and off. Set aside to be reinstalled later.



2. Just forward of the front tire, inside the wheel well, remove the three bolts using a 7MM socket. Do this to both sides of the vehicle. Set bolts aside to reinstall later.

Handling of some cosmetic parts when installing this product may require the use of protective covers, rags, specialty tools, etc. to prevent damage.

BX1984

2008-10 Chrysler Sebring Convertible Installation Instructions



3. Remove the push pins, one in each corner on the bottom side of the fascia (gray arrow). Then remove the nine bolts all the way around (white arrow) using a 7MM socket. Do this on both sides. To remove fascia, pull the corner out to the side and forward a little bit. Unplug the running lights and remove the fascia. Set fascia aside carefully to be reinstalled later.



4. Disconnect the sensor located underneath the bumper (gray arrow). Disconnect the tabs holding the transmission coolant line (white arrows). Set down in the tray right below to be reinstalled later.



5. On the driver's side, remove the horn using a 10MM socket to remove the bolt. Set the horn and the bolt aside to be reinstalled later.
7. Using a 13MM socket, remove the four bolts from the main bumper two on the top and two on the bottom. Do this on both sides. Set aside to be reinstalled later.



6. Remove the bolt holding the main brace with a 10MM socket. Do this on both sides. Set the bolt aside to be reinstalled later.

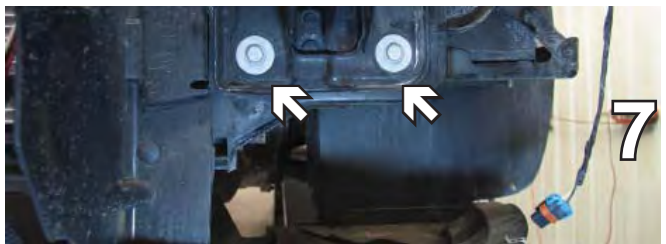

BX1984 2008-10 Chrysler Sebring Convertible Installation Instructions



8. Remove the bolt on the side of the headlight (white arrow) with the 10MM socket. Using a 25 Torx, remove the bolt on front (gray arrow). Do this on both sides. Set aside to be reinstalled later.



9. Using a 25 Torx, remove the bolt on the side of the headlight assembly. Do this on both sides. Set aside to be reinstalled later.

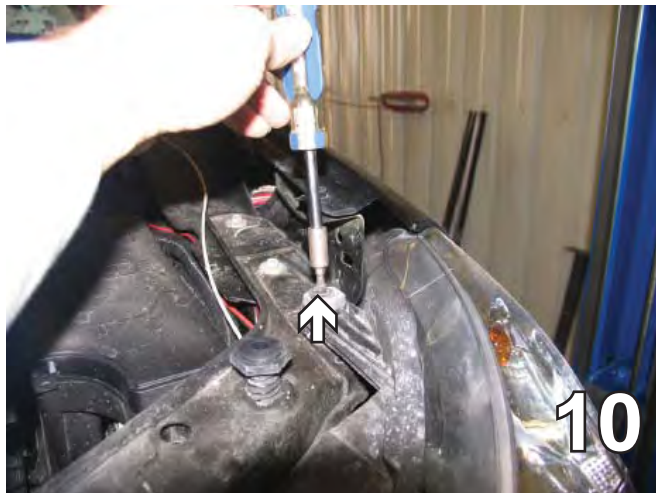

10. Using a 25 Torx, remove the bolt above the headlight. Do this on both sides. Set the bolts aside to be reinstalled later.



11. Remove the torx bolt (11A) with a 25 Torx socket. Just under the torx, using a pliers, screw out the plastic plug (11B) and remove the headlight. Do this on both sides. Set aside to be reinstalled later.

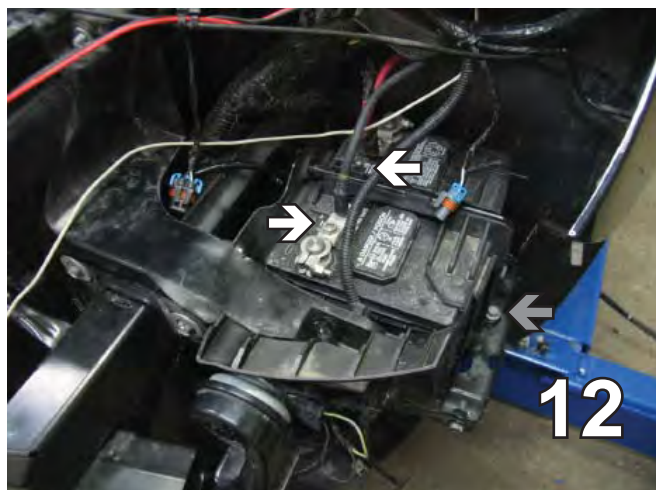

13. On the driver's side, use a 12MM socket to remove the bolt on the ground side and a 10MM socket for the positive side of the battery. Use a 13MM socket for the bolt on the battery bracket (gray arrow). Remove the battery and bracket, set aside to be reinstalled later.

BX1984

2008-10 Chrysler Sebring Convertible

Installation Instructions

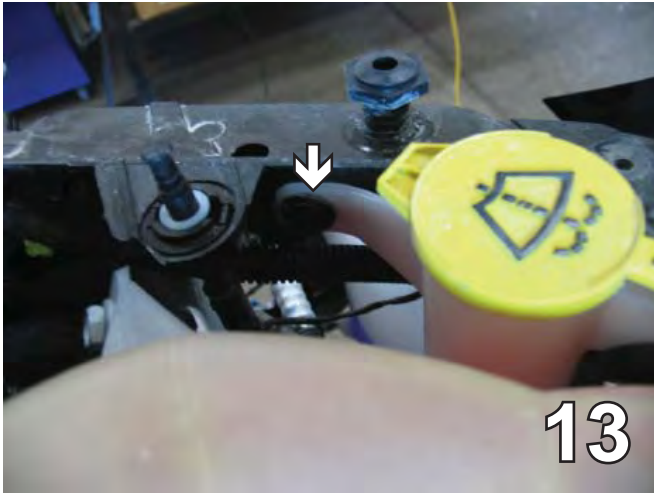

13. On the passenger side, on the top of the washer reservoir remove the push pin.

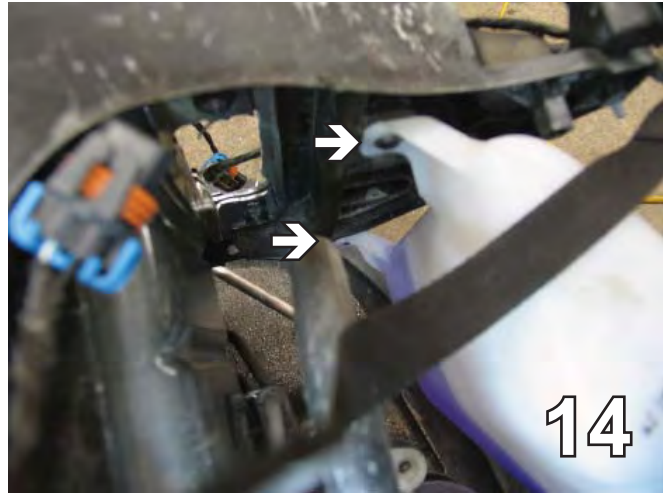

14. Use a 25 Torx to unscrew the two bolts on the inside of the washer reservoir. Set aside to be reinstalled later.



15. Using a 10MM socket, remove the bolt on the outside of the washer reservoir. You will then need to unplug the hoses and electrical connections. Set the bolts and washer reservoir aside to be reinstalled later.



16. On the driver's side, in front of the tire, remove the push pin. Set aside to be reinstalled later.

17. On the driver's side, remove the five bolts with a 13MM socket and take the battery tray off. Set aside to be reinstalled later.

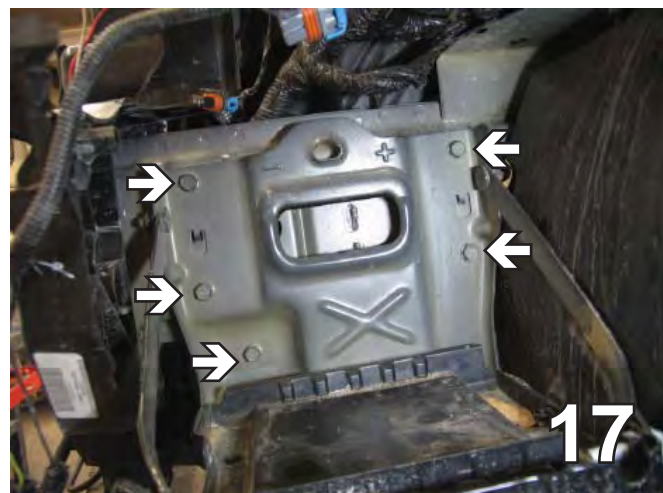

BX1984

2008-10 Chrysler Sebring Convertible

Installation Instructions

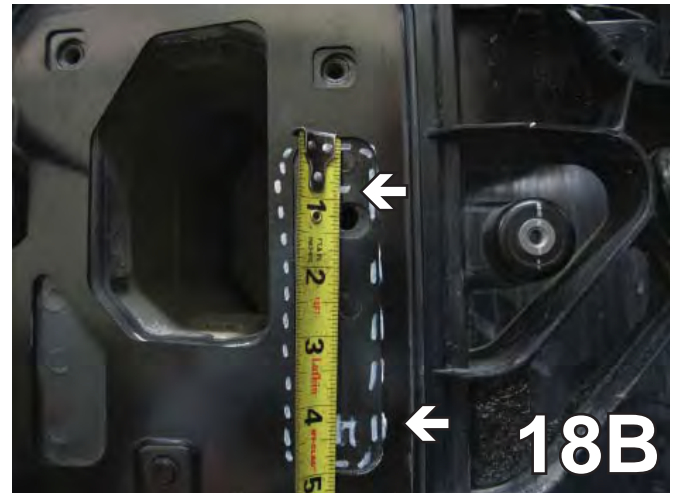
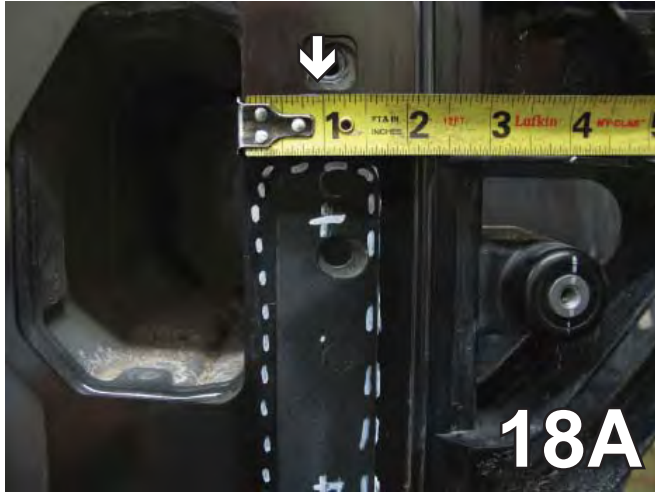

18. Trim out around the groove, a little to the outside, so the cut is flush with the frame. Measure in 1" from the hook and 3/4" down, this will be the center of the hole. Do the same on the bottom.

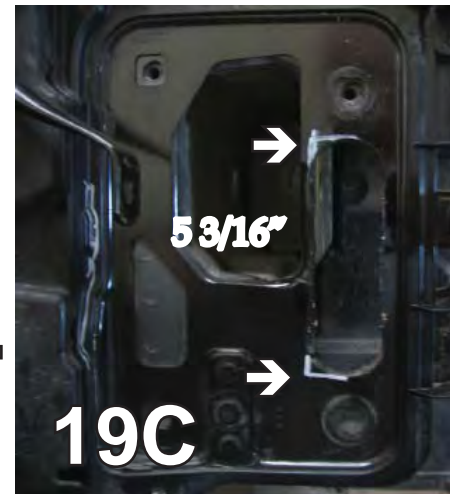
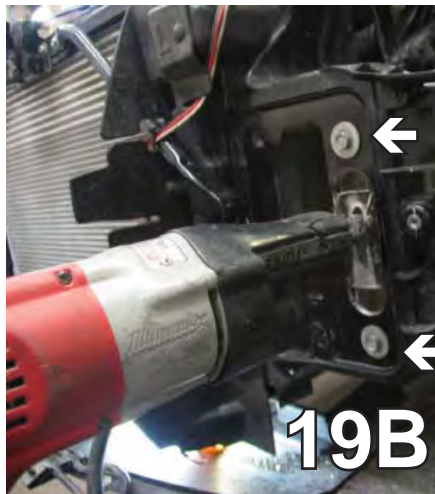

19. Using the 1 1/2" hole saw, drill on both ends with the reciprocating saw finish trimming. The bolts in step 19B may be reinserted to stabilize. Make the cut on the inside square. It should measure 5 3/16" inside to inside. Do this on both sides. Paint the cut edges of the frame to prevent rusting.



Using a good quality paint, spray cut edges of frame to prevent rusting.

When using power drills be aware of the dangers of torque and drill bit length.

20. Reattach the bumper and brace from step 6 to the bumper.

BX1984

2008-10 Chrysler Sebring Convertible

Installation Instructions

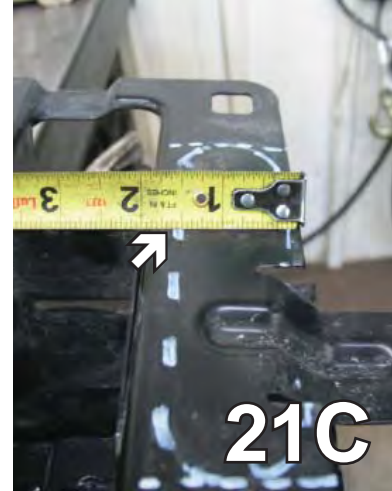
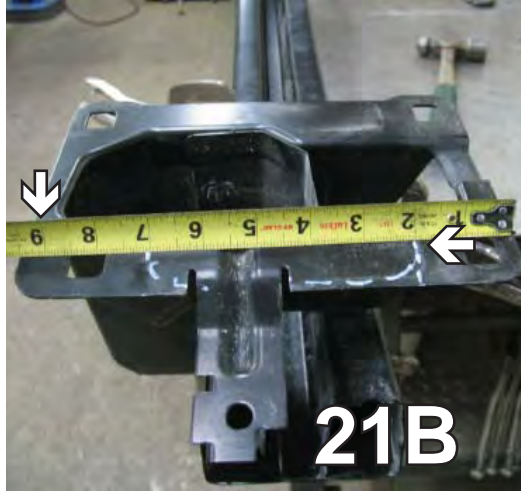

21. On the backside of the bumper, using the front as a template, mark the general area to be trimmed. The area should leave 2" at the top and be 1 3/4" wide. Trim making the cut on the inside square. This is so the bumper will fit back on after the baseplate is installed. Do this on both sides.

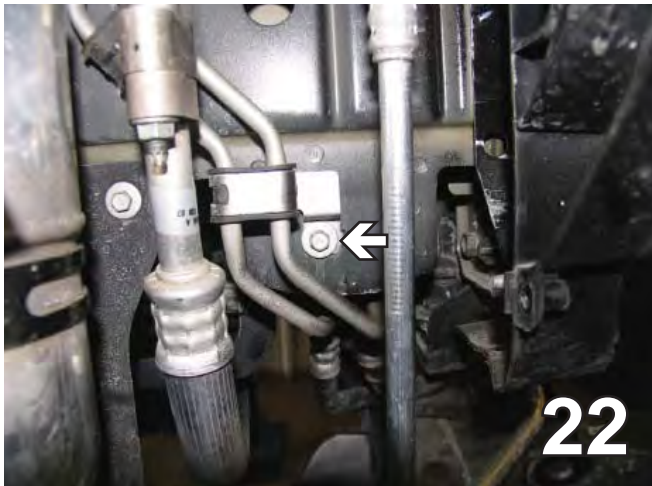

22. In order to slide the baseplate in, remove the bolt with a 10MM socket. It will be replaced later.

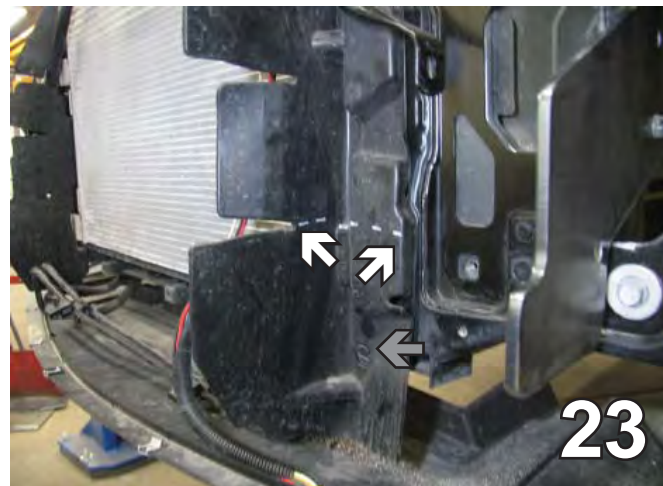

23. Remove the push pin (gray arrow). Start at the groove, trim and discard the rubber guard. Do this on both sides.

24. By the latch, remove the two bolts with a 10MM socket in order to move the brace down and out of the way to get the bumper back on.



BX1984
2008-10 Chrysler Sebring Convertible
Installation Instructions



25. Reattach the horn on both sides.

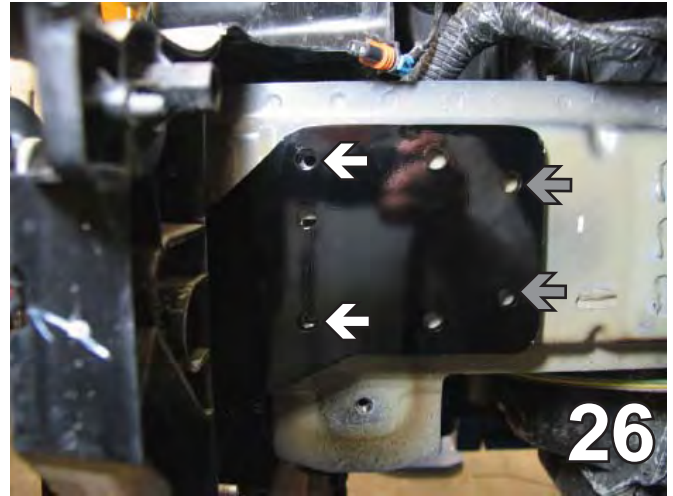

26. Slide the baseplate into our cut slots. On the driver's side, start 8MM-1.25 x 35 MM bolts in the two existing front holes (white arrows). (No Loctite at this time.) Using the 13/32" drill bit, drill the back two holes. Then install the 3/8-16 x 1 1/4" bolts, 3/8" lock washers to the 3/8-16 nut plates placed inside the frame. Use Loctite Red on the bolts.



27. Measure out 3 3/8" just below the lower bumper from the bolt to the front edge of the baseplate on both sides. Be sure the baseplate is level across the top and clamp.

BE SURE TO USE LOCTITE® RED ON ALL BOLTS BEFORE TIGHTENING. TIGHTEN ALL BOLTS ACCORDING TO THE TORQUE CHART ON THE FRONT PAGE OF THESE INSTRUCTIONS OR ON PAGE 3 OF THE BASEPLATE TOWING GENERAL INSTRUCTIONS.

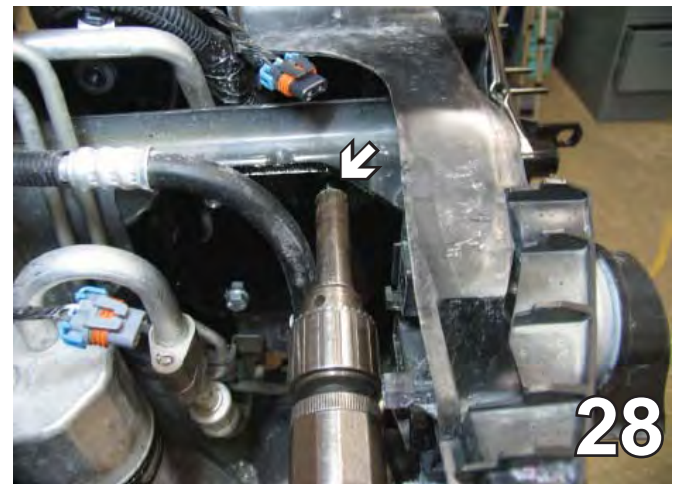

28. Using the baseplate as a template, drill the four holes on the passengers side with a 13/32" drill bit. See page 2 for drilled hole locations. Use a tube on the drill bit to prevent rubbing coolant lines when drilling all front four holes on the passenger side. Attach with 3/8-16 x 1 1/4" bolts and 3/8" lock washers to 3/8-16 nut plates placed inside the frame. Use Loctite Red on all bolts.

BX1984

2008-10 Chrysler Sebring Convertible

Installation Instructions

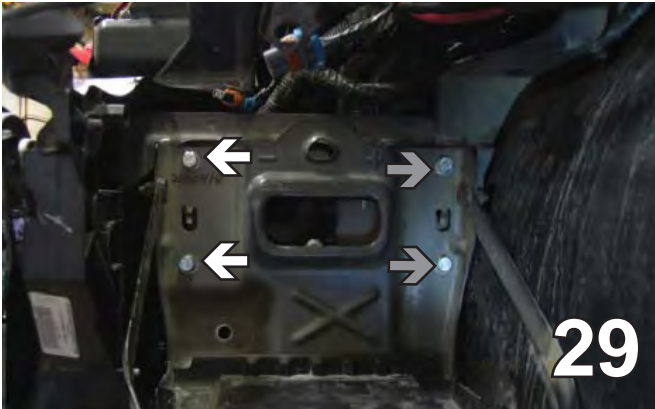

29. On the driver's side, remove the front two bolts from the base plate in order to put the battery tray back on. Reattach with four 8MM-1.25 x 35MM hex bolts and 8MM lock washers. Insert 1/2" spacers behind the battery tray in the front and 3/4" spacers in the back (gray arrows).



30. Measure down 2", straight in line with the other two and drill the third hole through the battery tray with a 13/32" drill bit to line up with the hole in the baseplate. Insert a 3/8-16 x 1 3/4" hex bolt and an 8MM lock washer with a 1/2" spacer and a 3/8-16 nut plate placed in the side frame.

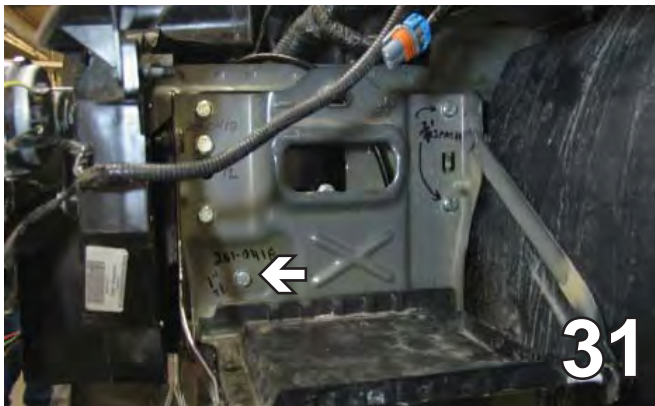

31. Insert a 8MM-1.25 x 50MM hex bolt and an 8MM lock washer with a 1" spacer in the lower hole.



32. Remove plastic battery tray liner and drill a 13/32" hole 1" back (closer to the engine). Reinstall the liner and push pin from step 17, to the wheel well.

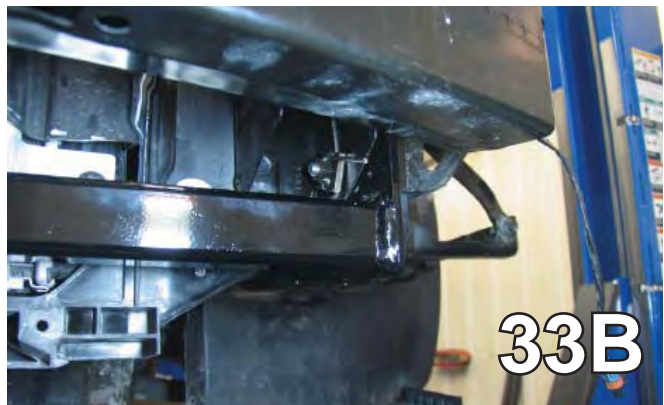
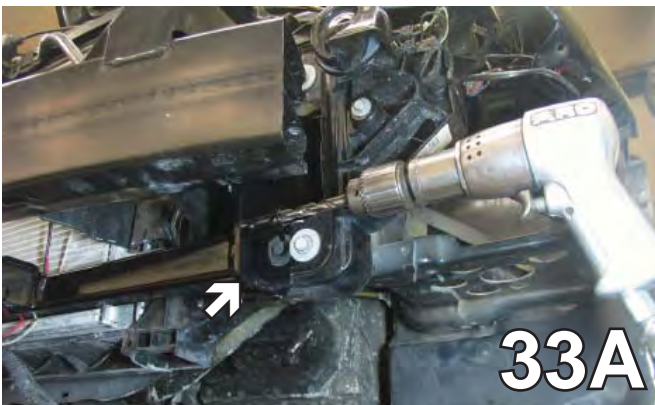

32. Reattach the bumper with existing bolts. Using a 13/32" drill bit, drill the hole into bumper support (33A). Insert 3/8-16 x 1 1/4" hex bolt with 3/8" lock washer and 3/8-16 nut plate on the back side of the bumper support (33B).

BX1984

2008-10 Chrysler Sebring Convertible

Installation Instructions

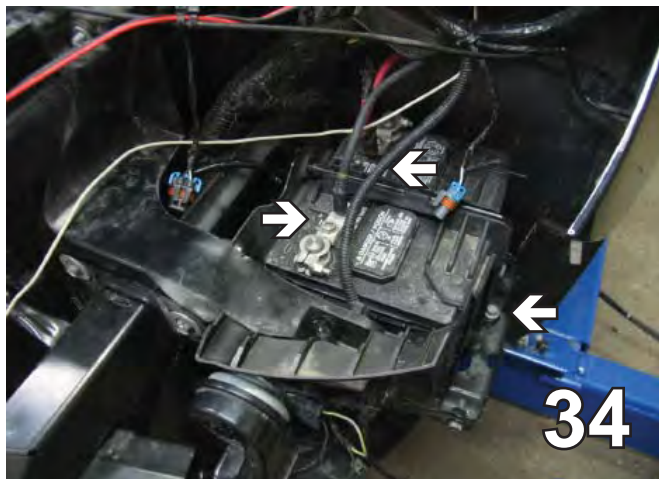

34. Reinstall the battery and reconnect.

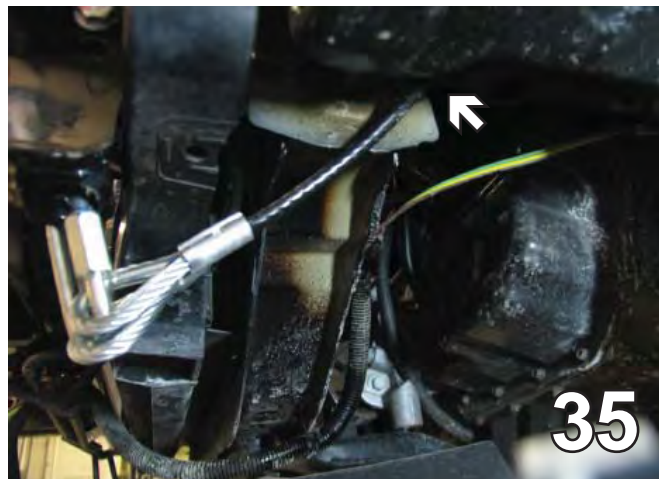

35. Attach the permanent baseplate safety cables to the provided convenience link on the baseplate (see grey arrow). The photo above shows the recommended installation of the cables to frame of vehicle (see white arrow). Additional options may interfere with suggested mounting; in this case secure the cables to a solid piece of the frame as described in the instructions included with the permanent baseplate safety cables. Be sure the safety cables do not rub against any hoses or moving parts. Do this to both sides of the vehicle.



36. Reinstall coolant line brace from step 22 with a 6MM-1.00 x 30MM bolt, 6MM lock washer and a 1/2" spacer. Then reattach the washer reservoir and reconnect the hoses and electrical connections with existing hardware.



37. Reinstall the headlight assembly, reconnect the transmission coolant line, reconnect the sensor, replug the running lights, reinstall the fascia and the grille.



38. If the vehicle has a license plate bracket, bend the tabs down for the wiring connection.

BX1984

2008-10 Chrysler Sebring Convertible

Installation Instructions

Be sure that ALL electrical connections are plugged in properly and functioning BEFORE installing the fascia.

DEALER OR INSTALLER: BE CERTAIN THE USER RECEIVES THE INSTRUCTION SHEETS.

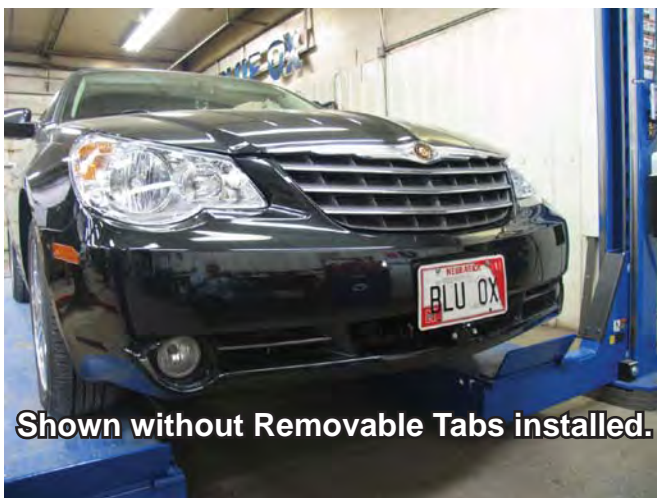

Shown without Removable Tabs installed.



Shown with Removable Tabs Installed.

If the baseplate is in an accident, it must be replaced. DO NOT use it again! An accident can cause unseen damage and using it again could result in more damage or serious injury. DO NOT use the baseplate if it is damaged or missing parts.

Install the tow bar and safety cables according to the instructions included in their packages.

Do not substitute other devices if the tow bar pin and clip are lost.

CUSTOMER SERVICE COMMITMENT

Blue Ox is committed to providing you with exceptional customer care throughout your lifetime with our products. Our team is here to assist you with any questions you may have regarding the performance of your product. Simply call (402) 385-3051 and you can speak with our customer care team.

Additionally, please visit our website to see which rallies our Destination America team will be attending. For a nominal fee, our service technician will service your towing system to ensure it's in proper working condition. Also as a commitment to our customers, should you visit our factory you can stay at our full service Blue Ox campground at no charge along with enjoying a factory tour.

Again thank you for being our customer and for the confidence you have shown in the performance of our products. It is because of customers like you we enjoy the success we have today.



© 2008, 09, 10 Blue Ox
One Mill Road, Industrial Park
Pender, Nebraska 68047
Phone: (402) 385-3051
Toll Free: (888) 425-5382
Fax: (402) 385-3360
www.blueox.com