



BX1985

2009-11 Dodge Journey SE Installation Instructions

Serial Number

Please read BOTH these Installation Instructions and the General Instructions before attempting to install or operate this equipment.

- Blue Ox® towing products and accessories are intended to be installed by Blue Ox® Dealers who are familiar with our products and have the equipment necessary and knowledge to do "fit work". When necessary Blue Ox® Dealers can be found at www.blueox.com or by contacting our Customer Care Department at (402) 385-3051.
- Many Blue Ox® Baseplates are designed to use existing holes and hardware to mount the baseplate to the towed vehicle. Even though bolts are there, do not assume they are adequate for baseplate mounting. Always use hardware supplied in the hardware kit and existing hardware specified in the Baseplate Installation Instructions.

Attachment Tab Height: 15"

Attachment Tab Width: 22"

Bolt Torque Specifications
Torque in Foot-Pounds for Metric Bolts

Bolt Size	Grade 8.8	Grade 10.9
6MM	6	8
8MM	16	22
10MM	31	40
12MM	54	70
14MM	89	117

Confirm the towability and pre-towing procedures for your vehicle with the owner's manual or contact the vehicle's manufacturer for specific towing procedures.

Bolt Torque Specifications
Torque in Foot-Pounds for Inch Bolts

Bolt Size	Grade 5	Grade 8
1/4"	10	14
5/16"	19	29
3/8"	33	47
7/16"	54	78
1/2"	78	119
5/8"	154	230



If the front of your vehicle looks different than this, call us at (402) 385-3051.

! WARNING

Failure to read and follow these instructions could result in separation of the towed vehicle from the tow bar, causing property damage, loss of towed vehicle, personal injury or death.

BX1985

2009-11 Dodge Journey SE

Installation Instructions

Parts List

Ref. No.	Qty.	Part #	Description
1	1	61-6582	WLDM'T, BP, BX1985
2	6	61-5208	WLD, NUT PLT, 1/4X1X1, 3/8"/14"WIRE
3	4	201-0418	8MM-1.25 X 35MM HEX BOLT GRD.8.8 ZP
4	4	203-0102	8MM LOCK WASHER, ZP
5	9	201-0368	3/8-16 X 1 1/4 HEX HEAD BOLT,GRD. 5
6	9	203-0010	3/8 LOCK WASHER, ZP
7	3	203-0003	3/8 FLAT WASHER, ZP
8	3	202-0090	3/8-16 HEX NYL. INS. LOCK NUT, ZP
9	2	201-0553	1/4-20 X 1/2 HX.WSHD.TYPE F TCS, ZP
10	2	201-0192	10-32 X 1/2 SLOT, RD. HD. SCREW
11	2	203-0054	#10 LOCK WASHER
12	2	202-0047	#10-32 HEX NUT
13	2	101-5822	ADAPTER, 4 WAY CONNECTOR
14	2	62-3469	ATT TAB ASSY, REM, SF/LB, 1 HOLE
	2	226-0046	BASEPLATE SAFETY CABLE, 36" CL III (NS)
	2	229-0359	QUICKLINK, 3/8, ZP (Not Shown)
	2	290-0437	RECEIVER, CAP PLUG (BLK) (Not Shown)

Tools Required

7MM Socket	Large Vise Grips
10MM Socket	Reciprocating Saw
13MM Socket	Pliers
9/16" Socket	1 1/4" Hole Saw
9/16" Wrench	13/32" Drill Bit
	LOCTITE Red

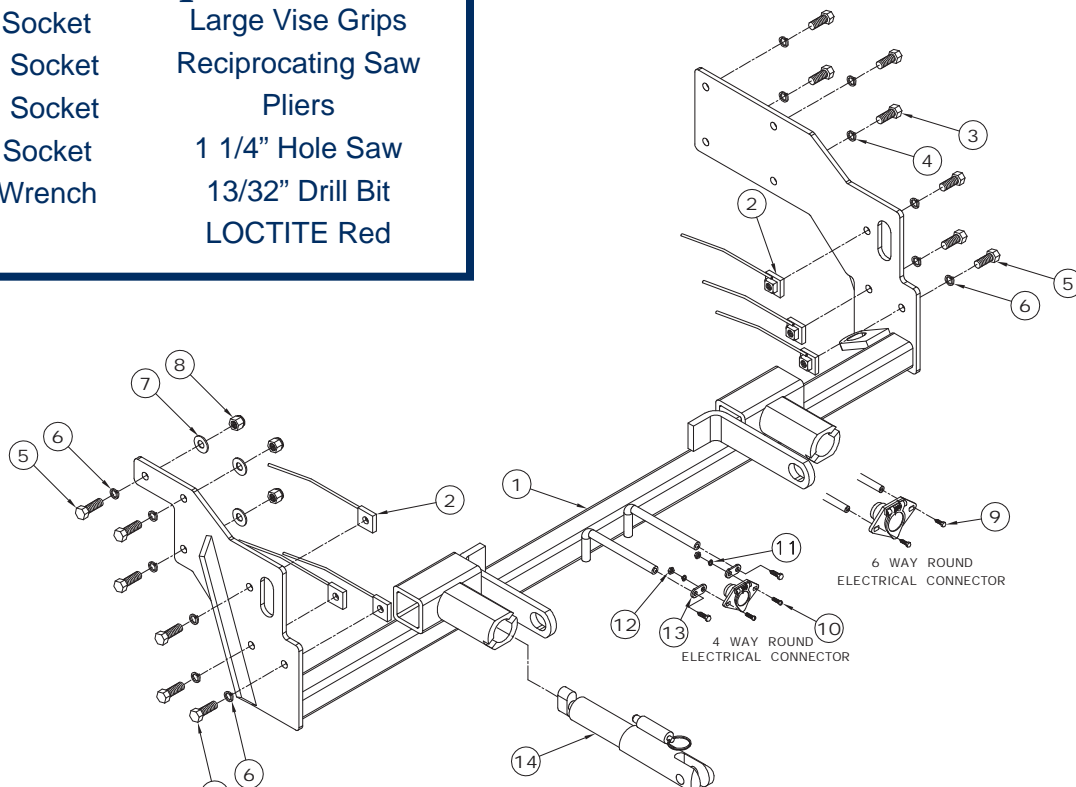

Important:

Use only genuine factory replacement parts on your baseplate. Do NOT substitute homemade or non-typical parts. If a bolt is lost or in need of replacement, for your safety and the preservation of your baseplate, be sure to use a replacement bolt of the same grade (In most cases it will be Grade 5, please reference the parts list above). Replacement parts may be ordered through your nearest Blue Ox® Dealer or Distributor, or call our Customer Care Team at (402)385-3051. Failing to follow and/or altering these installation instructions in either installation or required equipment will void the manufacturer's warranty.

BX1985

2009-11 Dodge Journey SE

Installation Instructions

Removable Tab:

Motorhome mount tow bars are recommended for use with this baseplate. Due to the design of the removable tabs, the RangeFinder II and Ambassador tow bars can not be used. Adapters, except the BX8833 and the BX88151, can not be used with this baseplate.

Instructions:

The fascia, bumper, headlight assembly, battery, battery case, bolts and push pins are removed and reinstalled for the baseplate installation. Drilling is required. Trimming is required.

The dimensional variations between otherwise identical vehicles can be considerable. While the baseplate was designed for easy installation, it may be necessary to tailor the baseplate slightly to compensate for auto manufacturer's tolerances. These minor adjustments may include filing a hole slightly, bending electrical rods or bending end plates.

The BX8869, Bulb and Socket Wiring Kit is recommended for this vehicle.



Installation Instructions



1. Remove five push pins, three on the driver's side and two on the passenger side. Set push pins aside to be reinstalled later.



2. Just forward of the front tire, inside the wheel well, remove the three push pins. Do this to both sides of the vehicle. Set push pins aside to reinstall later.

Handling of some cosmetic parts when installing this product may require the use of protective covers, rags, specialty tools, etc. to prevent damage.

BX1985
2009-11 Dodge Journey SE
Installation Instructions



3. Just forward of the front tire, inside the wheel well, up in the corner, using a 7MM socket remove the bolt. Do this to both sides of the vehicle. Set bolts aside to reinstall later.



4. Remove the push pins, one in each corner underneath the fascia. Do this on both sides.



5. Then remove the four push pins all the way around. Do this on both sides.



6. To remove fascia, pull the fascia and unhook the notches. Set fascia aside carefully to be reinstalled later.

7. Remove a push pin from the top of the bumper on both sides (gray arrow). Using a 13MM socket, remove the four bolts from the main bumper two on the top and two on the bottom. Do this on both sides. Set aside to be reinstalled later.

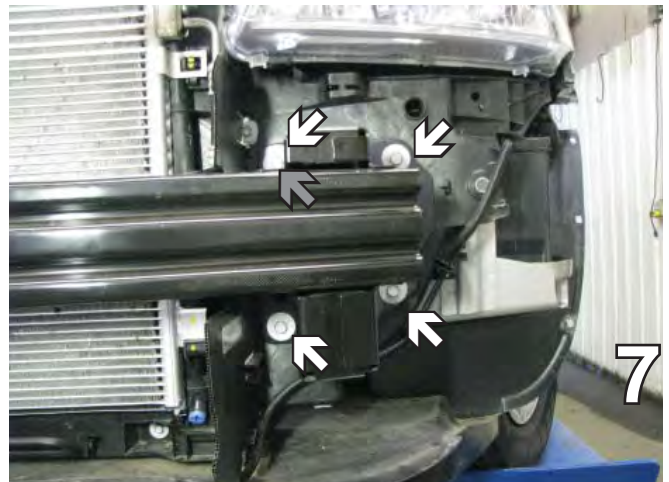

BX1985
2009-11 Dodge Journey SE
Installation Instructions



8. Remove the bolt on the side of the bumper with the 8MM socket. Do this on both sides. Set aside to be reinstalled later.

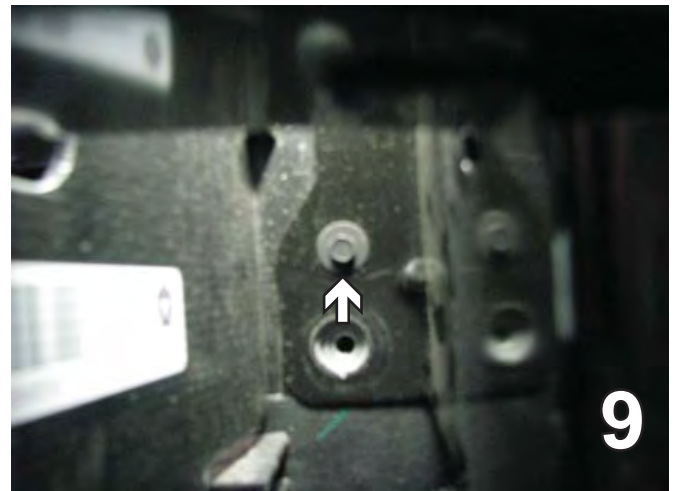

9. Using a 8MM socket, remove the bolt on the bottom of the bumper toward the inside. Do this on both sides. Set bumper and bolts aside to be reinstalled later.

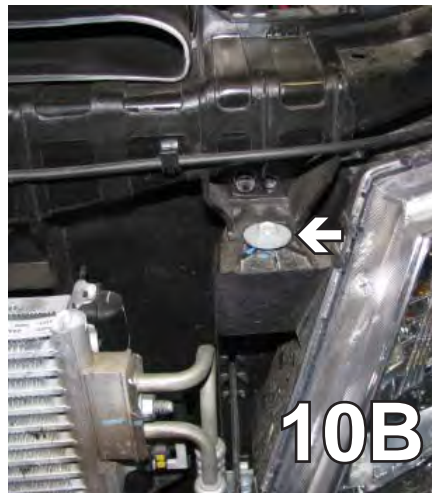

10. Using a 10MM socket, remove the three bolts around the headlight. Pull the headlight forward, disconnect and set aside to be reinstalled later. Do this on both sides.

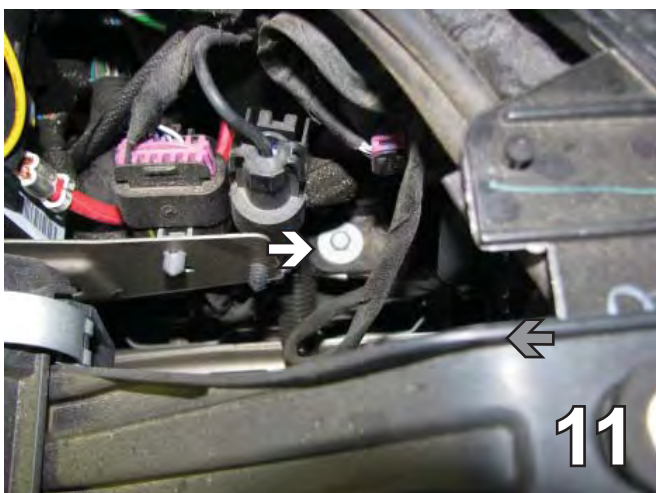

11. Use a 10MM socket with extension to remove the bolt behind the headlight. Do this on both sides. Set aside to be reinstalled later.

BX1985

2009-11 Dodge Journey SE

Installation Instructions



12. On the driver's side, use a 10MM socket to remove the two bolts on the sides (white arrows). Use a 13MM socket to take the nut off the back (gray arrow). Slide the battery out the side and set aside to be reinstalled later.

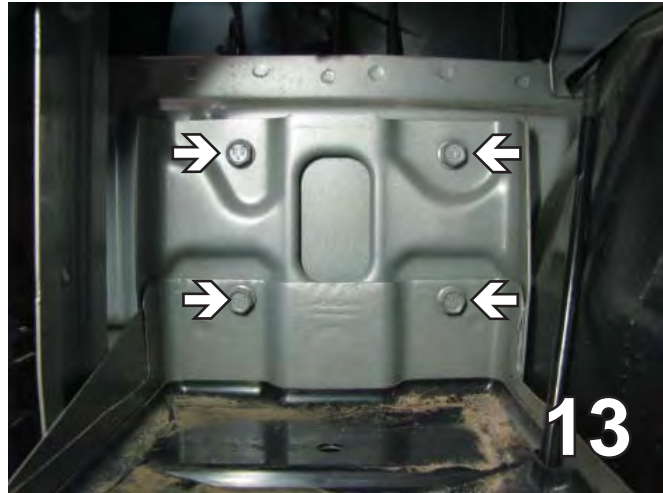

13. Use a 13MM socket to remove the four bolts on the battery case. Take the case out and set aside with the bolts to be reinstalled later.



14A. Saw out a slot by first measuring 7/8" in from the inside. Using a 1 1/4" hole saw, drill where the bumper bolts were on both ends. Use a reciprocating saw to connect the cuts. Do this on both sides.

When using power drills be aware of the dangers of torque and drill bit length.

Using a good quality paint, spray cut edges of frame to prevent rusting.

15. Using a reciprocating saw, trim up both sides. Take a pair of vice grips and twist off at the top. Do this on both sides.

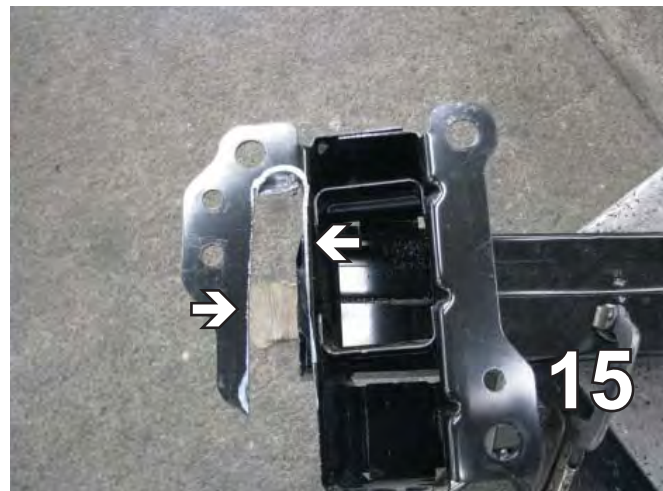

BX1985
2009-11 Dodge Journey SE
Installation Instructions

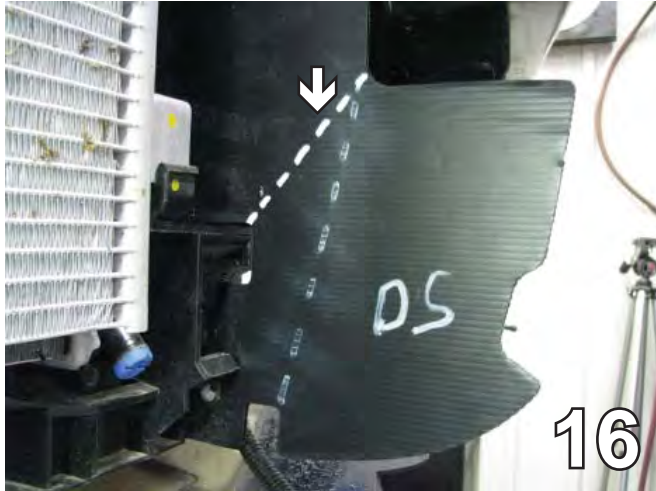

16. Using a reciprocating saw, trim from corner to corner as shown on the driver's side.

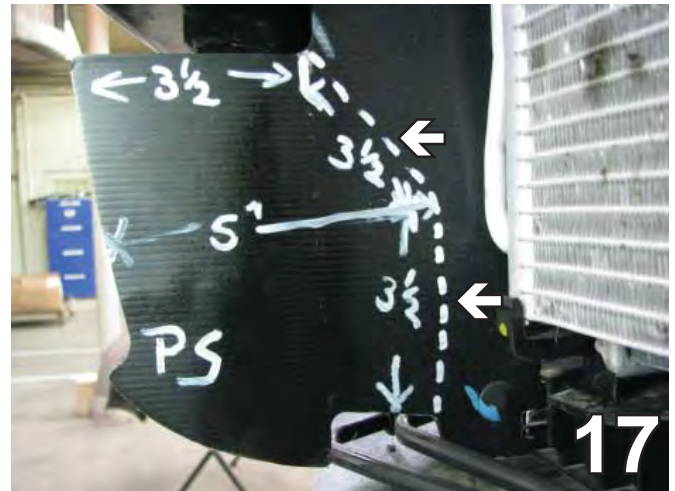

17. On the passenger side, measure 3 1/2" across at the top, 3 1/2" down and 3 1/2" down and 5" across the middle. Trim using a reciprocating saw.

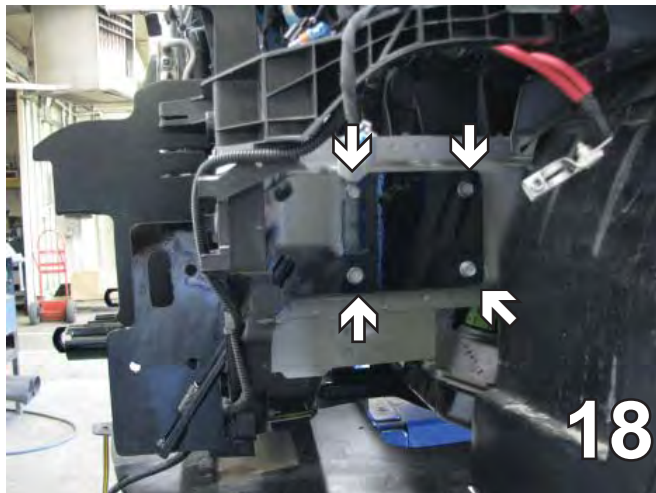

18. On the driver's side, slide the baseplate in place, line up with the four holes that held the battery case. Start 8MM-1.25 MM x 35MM bolts with 8MM lock washers in all four holes.

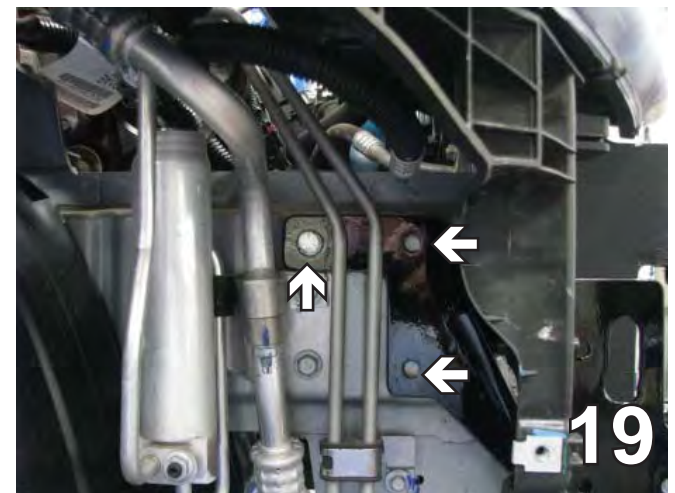

19. On the passenger side, line up the baseplate and be sure it is level with the frame. Using the 13/32" drill bit, drill the left hole first. Insert 3/8-16 x 1 1/4" bolt with 3/8" lock washer and tighten to 3/8" flat washer and 3/8-16 nyloc nut on the inside. Drill the other two holes. Tighten with bolts, washers and nuts. Use Loctite Red on all bolts.

BE SURE TO USE LOCTITE® RED ON ALL BOLTS BEFORE TIGHTENING. TIGHTEN ALL BOLTS ACCORDING TO THE TORQUE CHART ON THE FRONT PAGE OF THESE INSTRUCTIONS OR ON PAGE 3 OF THE BASEPLATE TOWING GENERAL INSTRUCTIONS.

BX1985
2009-11 Dodge Journey SE
Installation Instructions

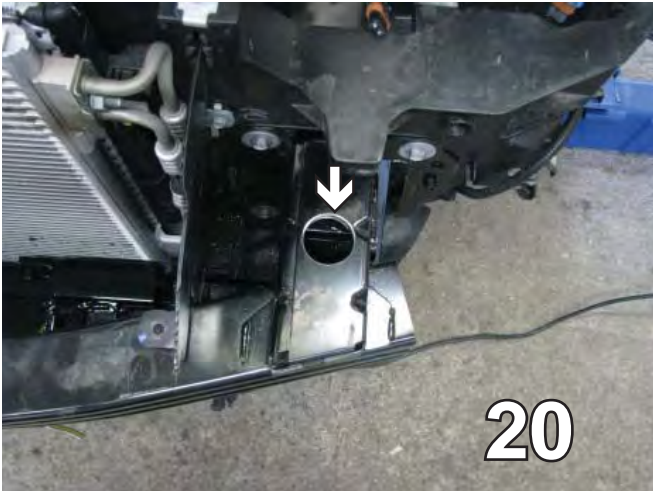

20. Reattach the bumper with existing bolts. Using the baseplate as a template with the 13/32" drill bit, drill three holes on both sides. Using 1 1/4" hole saw drill one hole on top on both sides.

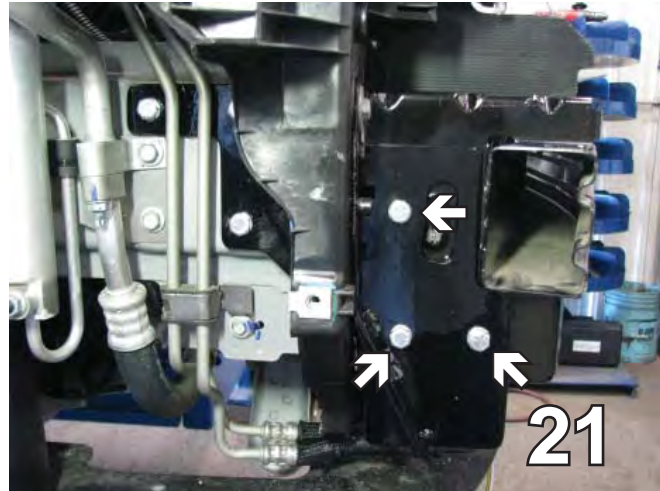

21. For all three holes use 3-8"-16 x 1 1/4" bolts with 3/8" lock washers attached to 3/8-16 nut plates inserted on the inside. Use Loctite Red on all bolts. Do this on both sides.

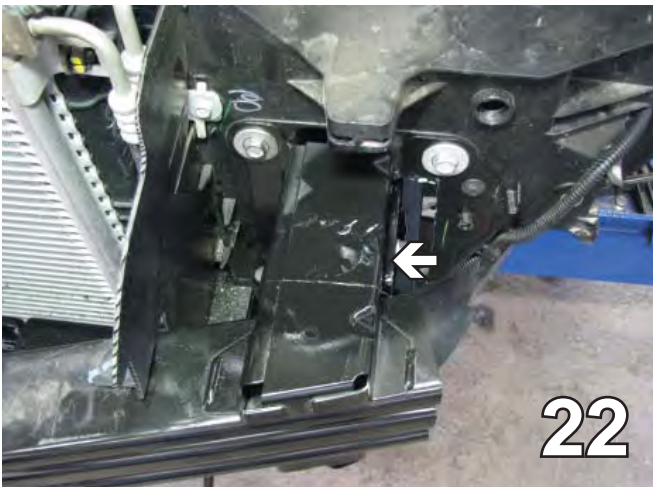

22. Place tape over the top hole and paint black.

Install the tow bar and safety cables according to the instructions included in their packages.

Do not substitute other devices if the tow bar pin and clip are lost.

DEALER OR INSTALLER: BE CERTAIN THE USER RECEIVES THE INSTRUCTION SHEETS.



23. On the driver's side, reinstall the battery tray and attach the baseplate with 8MM-1.25 MM x 35MM bolts and 8MM lock washers in all four holes. Use Loctite Red on all bolts.

24. Reinstall the battery and reconnect.

25. Attach baseplate safety cables. Position the cables around a solid piece of the frame and to the baseplate.

26. Reinstall the headlight assembly, replug the lights, and reinstall the fascia.

Be sure that **ALL** electrical connections are plugged in properly and functioning **BEFORE** installing the fascia.

BX1985
2009-11 Dodge Journey SE
Installation Instructions



Shown without Removable Tabs installed.



Shown with Removable Tabs Installed.

If the baseplate is in an accident, it must be replaced. DO NOT use it again! An accident can cause unseen damage and using it again could result in more damage or serious injury. DO NOT use the baseplate if it is damaged or missing parts.

DEALER or INSTALLER:
Be certain the user receives the instruction sheets for their products.

CUSTOMER SERVICE COMMITMENT

Blue Ox is committed to providing you with exceptional customer care throughout your lifetime with our products. Our team is here to assist you with any questions you may have regarding the performance of your product. Simply call 1-402-385-3051 and you can speak with our customer care team.

Additionally, please visit our website to see which rallies our Destination America team will be attending. For a nominal fee, our service technician will service your towing system to ensure it's in proper working condition. Also as a commitment to our customers, should you visit our factory you can stay at our full service Blue Ox campground at no charge along with enjoying a factory tour.

Again thank you for being our customer and for the confidence you have shown in the performance of our products. It is because of customers like you we enjoy the success we have today.



© 2008, 09, 11 Blue Ox
One Mill Road, Industrial Park
Pender, Nebraska 68047
Phone: (402) 385-3051
Toll Free: (888) 425-5382
Fax: (402) 385-3360
www.blueox.com
2/11/11