



BLUE OX®

Baseplate Installation Instructions

BX1993 2010-11 Mitsubishi Lancer ES/ES Sport Installation Instructions

Serial Number

Please read BOTH these Installation Instructions and the General Instructions before attempting to install or operate this equipment.

- Blue Ox® towing products and accessories are intended to be installed by Blue Ox® Dealers who are familiar with our products and have the equipment necessary and knowledge to do "fit work". When necessary Blue Ox® Dealers can be found at www.blueox.com or by contacting our Customer Care Department at (402) 385-3051.
- Many Blue Ox® baseplates are designed to use existing holes and hardware to mount the baseplate to the towed vehicle. Even though bolts are there, do not assume they are adequate for baseplate mounting. Always use hardware supplied in the hardware kit and existing hardware specified in the Baseplate Installation Instructions.

Attachment Tab Height: 12"

Attachment Tab Width: 22"

Bolt Torque Specifications
Torque in Foot-Pounds for Metric Bolts

Bolt Size	Grade 8.8	Grade 10.9
6MM	6	8
8MM	16	22
10MM	31	40
12MM	54	70
14MM	89	117

Confirm the towability and pre-towing procedures for your vehicle with the owner's manual or contact the vehicle's manufacturer for specific towing procedures.

Bolt Torque Specifications
Torque in Foot-Pounds for Inch Bolts

Bolt Size	Grade 5	Grade 8
1/4"	10	14
5/16"	19	29
3/8"	33	47
7/16"	54	78
1/2"	78	119
5/8"	154	230

Do not use the towed vehicle for storing luggage, equipment, etc. This may cause you to exceed the towing capacity of the tow bar, baseplate, and its accessories.



If the front of your vehicle looks different than this, call us at (402) 385-3051.

! WARNING

Failure to read and follow these instructions could result in separation of the towed vehicle from the tow bar, causing property damage, loss of towed vehicle, personal injury or death.

BX1993

2010-11 Mitsubishi Lancer ES/ES Sport

Installation Instructions

Parts List

Ref. No.	Qty.	Part #	Description
1	1	61-6804	WLDM'T, BP, BX1993
2	11	61-5208	WLD, NUT PLT, 1/4X1X1, 3/8" WITH 14"WIRE
3	11	201-0368	3/8-16 X 1 1/4 HEX HEAD BOLT,GRD. 5
4	11	203-0010	3/8 LOCK WASHER, ZP
5	1	201-0418	8MM-1.25 X 35MM HEX BOLT GRD.8.8, ZP
6	1	203-0102	8MM LOCK WASHER, ZP
7	2	201-0553	1/4-20 X 1/2 HX.WSHD.TYPE F TCS, ZP
8	2	201-0192	10-32 X 1/2 SLOT, RD. HD. SCREW
9	2	203-0054	#10 LOCK WASHER
10	2	202-0047	#10-32 HEX NUT
11	2	101-5822	ADAPTER, 4 WAY CONNECTOR
12	2	62-3468	ATT TAB ASSY, REM, SF/SB, 1 HOLE
13	1	102-7056	BREAKAWAY / COOLANT BRACKET
14	1	201-0050	1/4-20 X 3/4 HEX BOLT GRD.5, ZP
15	1	202-0102	1/4-20 HEX NYL NUT, ZP
16	1	201-0654	#10-16 X 1 SELF DRILLING SCREW
	2	226-0046	BASEPLATE SAFETY CABLE, 36" CL III (Not Shown)
	2	229-0359	QUICKLINK, 3/8, ZP (Not Shown)
	4	290-0275	CABLE TIE, 8 INCH NYLON (Not Shown)
	2	290-0437	RECEIVER, CAP PLUG (BLK) (Not Shown)

Tools Required

10MM Socket	Diagonal Cutters
12MM Socket	Drill
14MM Socket	Torque Wrench
9/16" Socket	Tape Measure
Large Vise Grip	13/32" Drill Bit
LOCTITE Red	

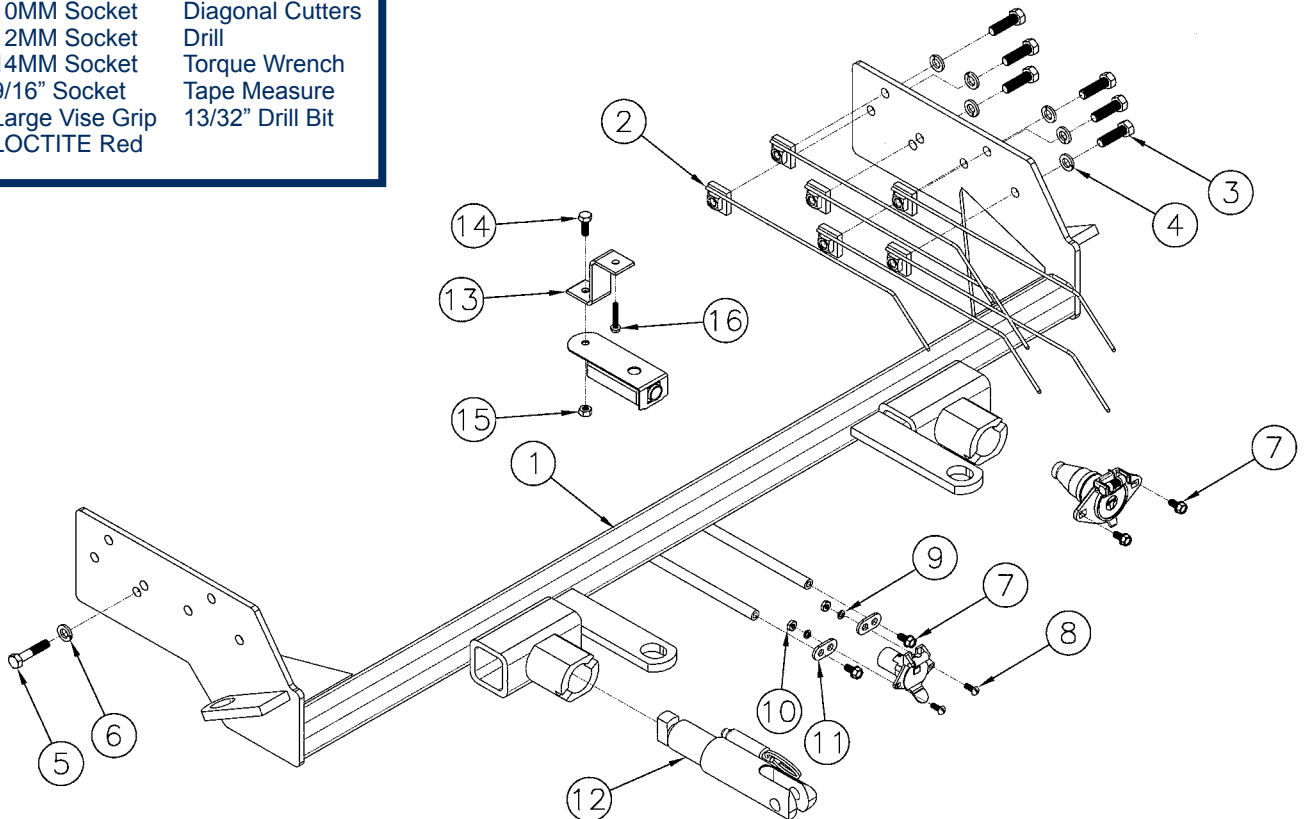

Important:

Use only genuine factory replacement parts on your baseplate. Do NOT substitute homemade or non-typical parts. If a bolt is lost or in need of replacement, for your safety and the preservation of your baseplate, be sure to use a replacement bolt of the same grade (In most cases it will be Grade 5, please reference the parts list above). Replacement parts may be ordered through your nearest Blue Ox® Dealer or Distributor, or call our Customer Care Team at (402)385-3051. Failing to follow and/or altering these installation instructions in either installation or required equipment will void the manufacturer's warranty.

BX1993

2010-11 Mitsubishi Lancer ES/ES Sport Installation Instructions

Removable Tab: Motorhome mount tow bars are recommended for use with this baseplate. Due to the design of the removable tabs, the RangeFinder II and Ambassador tow bars can not be used. Adapters, except the BX8833 and BX88151, can not be used with this baseplate.

Tow Bar Adapters are NOT to be used with vehicle's weighing over 5,000 lbs.

Instruction Notes: The plastic cover, fascia, license plate bracket, washer reservoir, bolts and push pins are removed and reinstalled for the baseplate installation. Drilling is required. Trimming of the bumper and the air dam is required.

The dimensional variations between otherwise identical vehicles can be considerable. While the baseplate was designed for easy installation, it may be necessary to tailor the baseplate slightly to compensate for auto manufacturer's tolerances. These minor adjustments may include filing a hole slightly, bending electrical rods or bending end plates.

The BX8869 Bulb and Socket Wiring Kit is available for this vehicle.

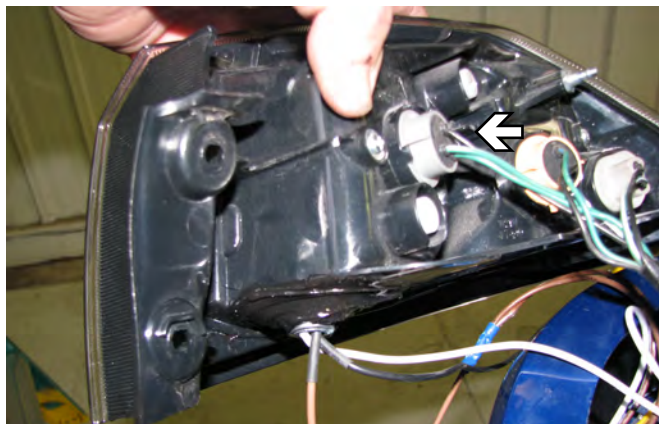

Possible location for the Bulb and Socket Wiring Kit (BX8869)

Installation Instructions:

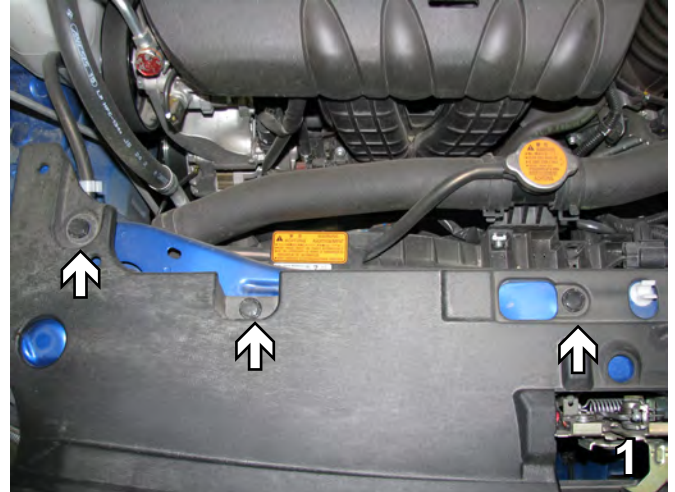

1. Remove three push pins from the top side of the plastic cover on the passenger side. Set the push pins aside to be reinstalled later.

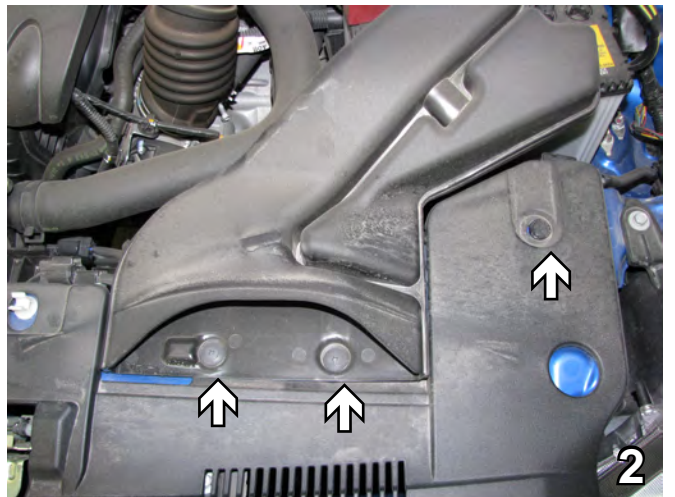

2. Remove three push pins from the top side of the plastic cover on the driver side. Set the plastic cover and the push pins aside to be reinstalled later.

Handling of some cosmetic parts when installing this product may require the use of protective covers, rags, specialty tools, etc. to prevent damage.

BX1993

2010-11 Mitsubishi Lancer ES/ES Sport

Installation Instructions

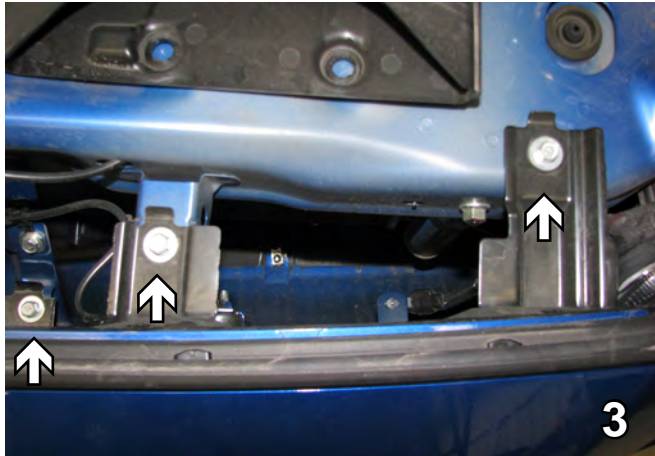

3. Using a 10MM socket remove two bolts from each side and one in the middle on the top front of the fascia, Set aside to be reinstalled later.

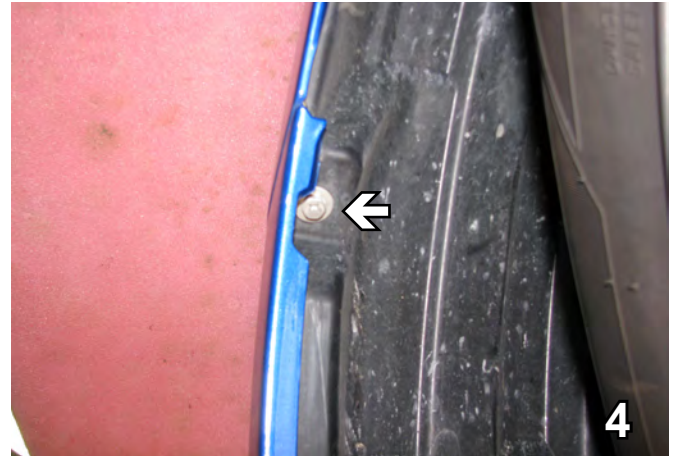

4. Using a 10MM socket, remove one metric bolt just forward of the front tire on the fascia edge. Do this on both sides. Set aside to be reinstalled later.

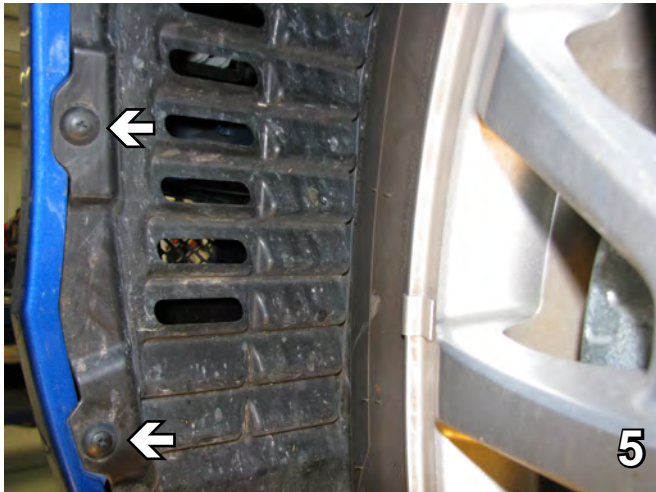

5. Remove two plastic push pins just forward of the front tire on the fascia edge, both sides. Set aside to be reinstalled later.

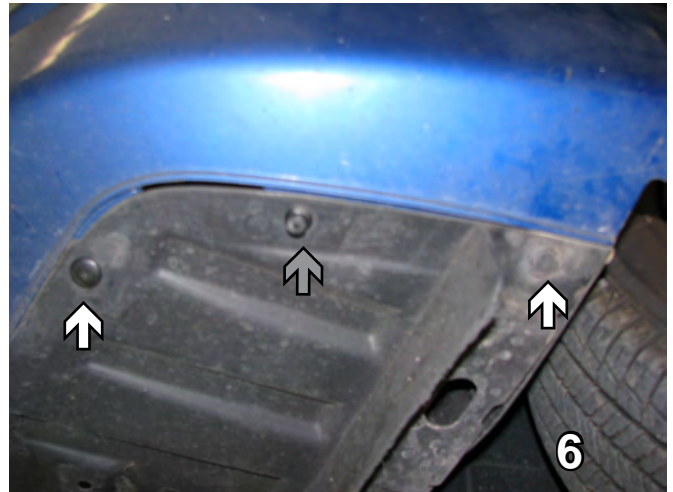

6. Remove two plastic push pins (white arrows) forward of the front tire on the bottom of the fascia in the corner. Between them, remove one Phillips push pin (gray arrow), both sides. Set aside to be reinstalled later.

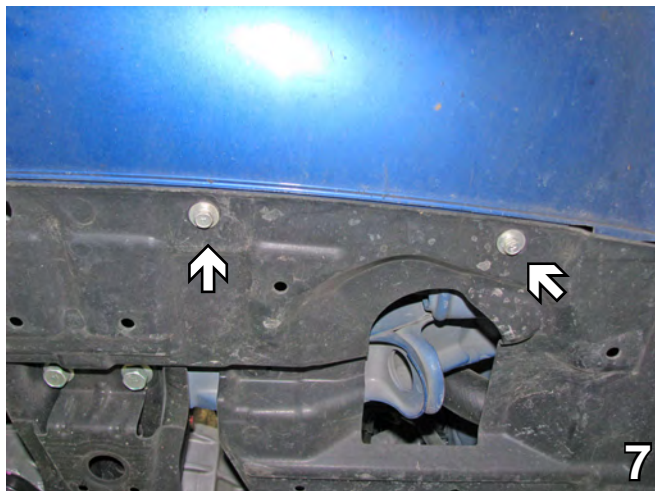

7. Underneath the fascia across the middle, remove six Phillips push pins. Set the pins and fascia aside carefully to be reinstalled later.

BX1993

2010-11 Mitsubishi Lancer ES/ES Sport

Installation Instructions



8. Using a Phillips screw driver, remove the two bolts from the license plate bracket. Set aside to be reinstalled later.



9. Remove the covers. Using a 10MM socket, remove the two bolts which were behind. Set the bolts aside to be reinstalled later.

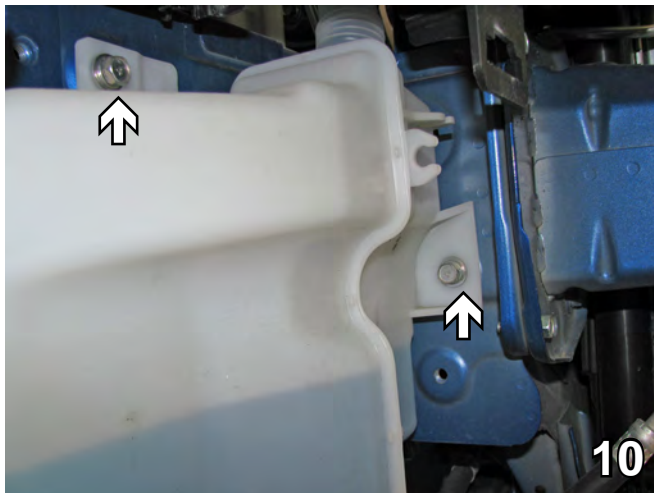

10. On the passenger side, using a 10MM socket, remove the two bolts from the washer reservoir. Set the bolts aside to be reinstalled later.



11. Using an 10MM socket, remove another bolt from the back side of the washer reservoir. Disconnect all hoses and electrical connections. Plug the hoses. Set bolt aside to be reinstalled later.



12. Using a 10MM socket, remove one bolt from the top of the washer reservoir. Set bolt and reservoir aside to be reinstalled later.

BX1993

2010-11 Mitsubishi Lancer ES/ES Sport

Installation Instructions

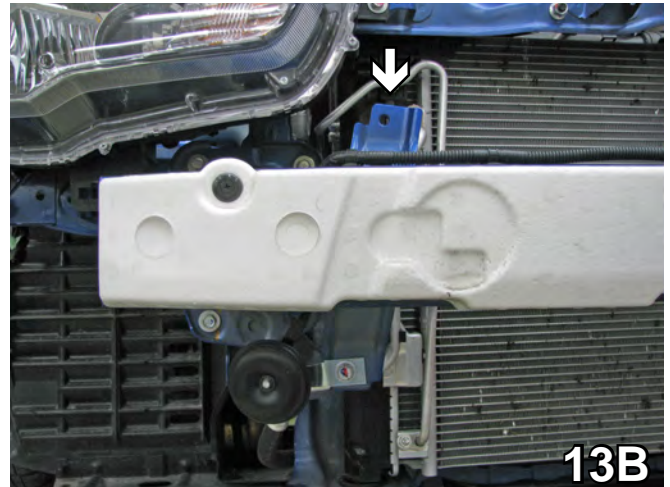
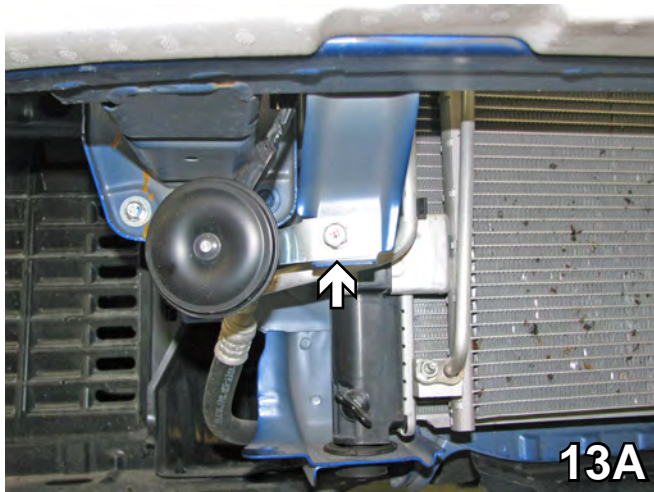

13. On the passenger side, using a 12 MM socket, remove the bolt from the horn. Move the horn above the bumper and bolt to the existing hole.

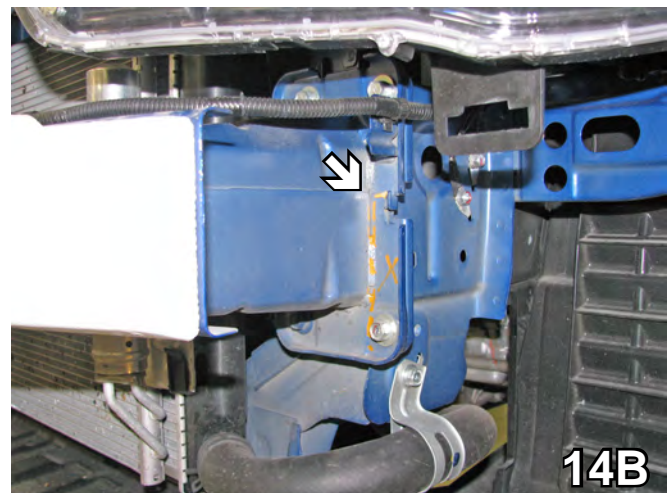

14A. On the passenger side, cut across flush with the seam and straight down.

14B. On the driver side, cut across the top of the corner of the frame and straight down through both pieces.



When using power drills be aware of the dangers of torque and drill bit length.

15. Remove the temperature sensor from below the bumper, flip it over and put it on the other side so that it is out of the way

BX1993

2010-11 Mitsubishi Lancer ES/ES Sport

Installation Instructions

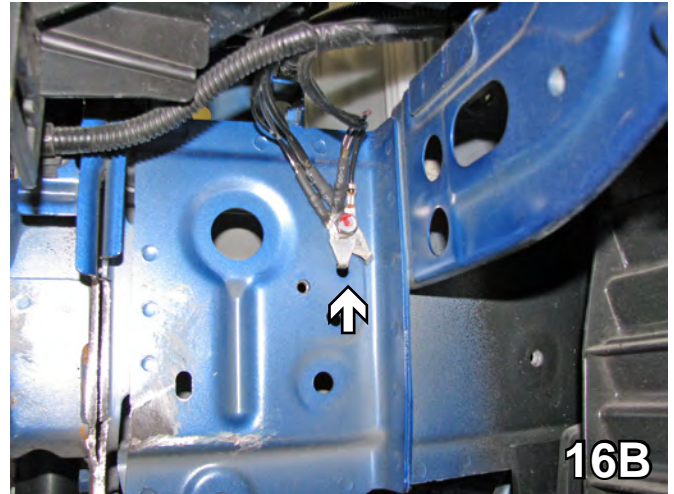
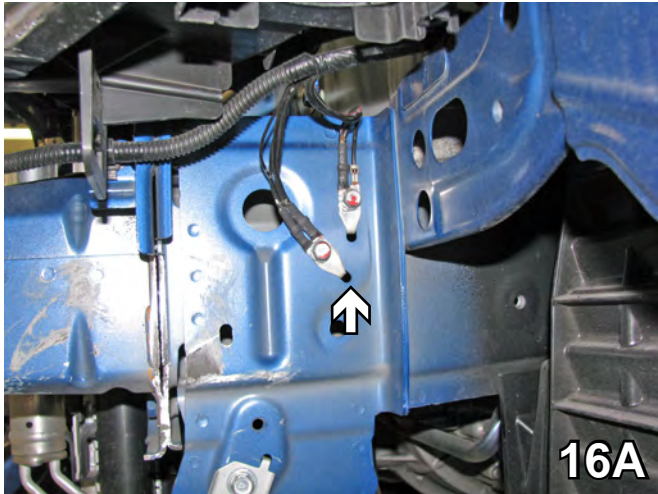

16. On the driver's side, take the bottom ground wire and move it up with the other one.

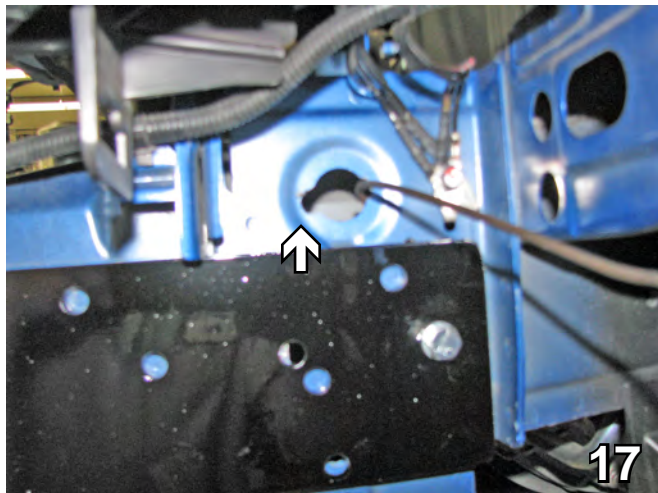

17. Cut a notch in the existing hole on each side of the frame in order to get the nut plate through.

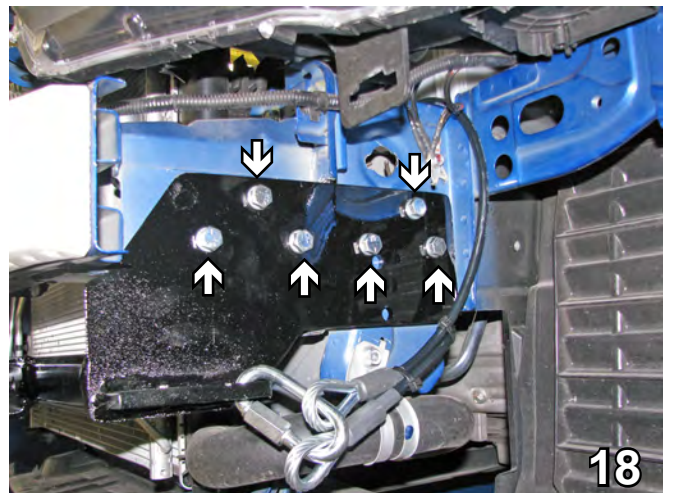

18. Insert 3/8-16 x 1 1/4" bolts, use Loctite, with 3/8" lock washers in all six holes on the driver side. Attach to 3/8-16 nut plates inserted into the hole in the frame. Use the existing back middle hole on the driver side. Do this on both sides except for the back middle hole.



19. Reinstall the washer reservoir, on the passenger side, into the back middle hole on the baseplate. Be sure to put all the hoses and electrical connections back in place.

BE SURE TO USE LOCTITE® RED ON ALL BOLTS BEFORE TIGHTENING. TIGHTEN ALL BOLTS ACCORDING TO THE TORQUE CHART ON THE FRONT PAGE OF THESE INSTRUCTIONS OR ON PAGE 3 OF THE BASEPLATE TOWING GENERAL INSTRUCTIONS.

BX1993

2010-11 Mitsubishi Lancer ES/ES Sport

Installation Instructions

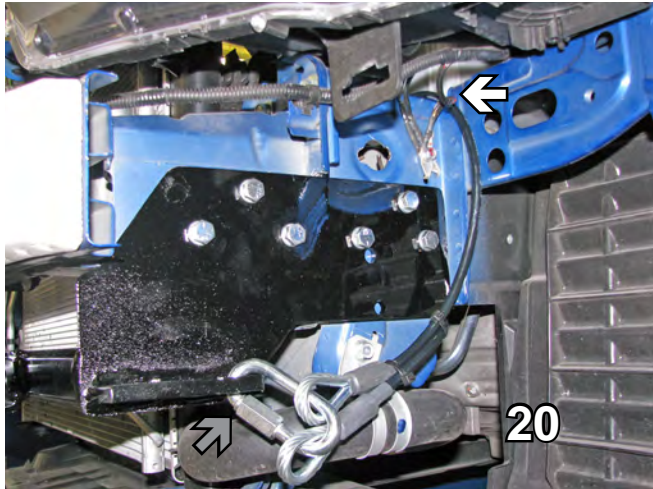

20. Attach the permanent baseplate safety cables to the provided convenience link on the baseplate (see grey arrow). The photo above shows the recommended installation of the cables to frame of vehicle (see white arrow). Additional options may interfere with suggested mounting; in this case secure the cables to a solid piece of the frame as described in the instructions included with the permanent baseplate safety cables. Use the cable ties to be sure the safety cables do not rub against any hoses or moving parts. Do this to both sides of the vehicle.

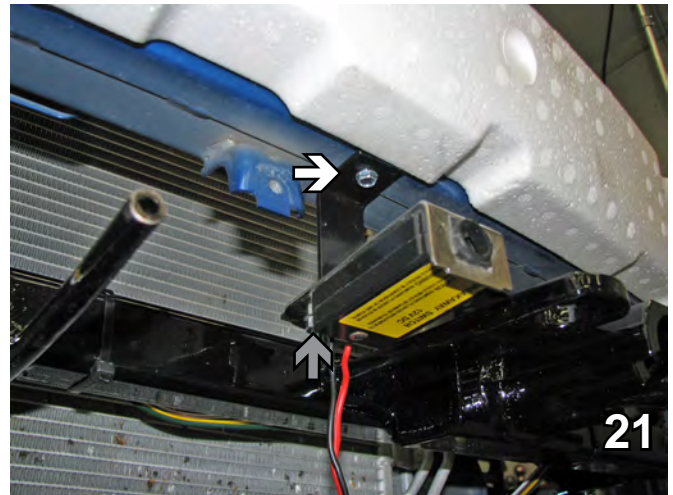

21. Attach the breakaway bracket to the bottom of the bumper with a 10-16 x 1" self drilling screw (white arrow). Fasten the breakaway to the bracket with 1/4-20 x 3/4" hex bolt and a 1/4-20 hex nut (gray arrow). Cut a hole in the fascia opening as needed to allow the bracket to go through.

22. Reinstall the fascia, license plate bracket, plastic cover, bolts and push pins.

Install the tow bar and safety cables according to the instructions included in their packages.

Do not substitute other devices if the tow bar pin and clip are lost.

Be sure that **ALL** electrical connections are plugged in properly and functioning **BEFORE** installing the fascia.

DEALER or INSTALLER:
Be certain the user receives the instruction sheets for their products.

BX1993

2010-11 Mitsubishi Lancer ES/ES Sport

Installation Instructions



Shown without removable tabs installed



Shown with removable tabs installed

CUSTOMER SERVICE COMMITMENT

Blue Ox is committed to providing you with exceptional customer care throughout your lifetime with our products. Our team is here to assist you with any questions you may have regarding the performance of your product. Simply call (402) 385-3051 and you can speak with our customer care team.

Additionally, please visit our website to see which rallies our Destination America team will be attending. For a nominal fee, our service technician will service your towing system to ensure it's in proper working condition. Also, as a commitment to our customers, should you visit our factory, you can stay at our full service Blue Ox campground at no charge along with enjoying a factory tour.

Again, thank you for being our customer and for the confidence you have shown in the performance of our products. It is because of customers like you we enjoy the success we have today.

If the baseplate is in an accident, it must be replaced. DO NOT use it again! An accident can cause unseen damage and using it again could result in more damage or serious injury. DO NOT use the baseplate if it is damaged or missing parts.



© 2011 Blue Ox
One Mill Road, Industrial Park
Pender, Nebraska 68047
Phone: (402) 385-3051
Fax: (402) 385-3360
www.blueox.com