



**BLUE OX®**

Baseplate Installation Instructions

**BX1995**

# 2011-12 Mitsubishi Outlander Sport Installation Instructions

**Please read BOTH these Installation Instructions and the General Instructions before attempting to install or operate this equipment.**

**Serial Number**

1. Blue Ox® towing products and accessories are intended to be installed by Blue Ox® Dealers who are familiar with our products and have the equipment necessary and knowledge to do "fit work". When necessary Blue Ox® Dealers can be found at [www.blueox.com](http://www.blueox.com) or by contacting our Customer Care Department at (402) 385-3051.

Attachment Tab Height: 19"

Attachment Tab Width: 22"

2. Many Blue Ox® baseplates are designed to use existing holes and hardware to mount the baseplate to the towed vehicle. Even though bolts are there, do not assume they are adequate for baseplate mounting. Always use hardware supplied in the hardware kit and existing hardware specified in the Baseplate Installation Instructions.

**Bolt Torque Specifications**  
Torque in Foot-Pounds for Metric Bolts

Bolt Size	Grade 8.8	Grade 10.9
6MM	6	8
8MM	16	22
10MM	31	40
12MM	54	70
14MM	89	117

**Confirm the towability and pre-towing procedures for your vehicle with the owner's manual or contact the vehicle's manufacturer for specific towing procedures.**

**Bolt Torque Specifications**  
Torque in Foot-Pounds for Inch Bolts

Bolt Size	Grade 5	Grade 8
1/4"	10	14
5/16"	19	29
3/8"	33	47
7/16"	54	78
1/2"	78	119
5/8"	154	230



**If the front of your vehicle looks different than this, call us at (402) 385-3051.**

**! WARNING**

Failure to read and follow these instructions could result in separation of the towed vehicle from the tow bar, causing property damage, loss of towed vehicle, personal injury or death.

# BX1995

## 2011-12 Mitsubishi Outlander Sport

### Installation Instructions

Tools Required		
8MM Socket	10MM Socket	12MM Socket
Drill	Torque Wrench	9/16" Socket
Large Vise Grips	Tape Measure	Utility Knife
1/4" Drill Bit	13/32" Drill Bit	Reciprocating Saw
Flat Screwdriver	Loctite® RED	

ITEM NO.	PART NUMBER	DESCRIPTION	QTY.
1	61-6950	WLDMT, BP, BX1995	1
2	61-5208	WLD, NUT PLATE, 1/4 X 1 X 1(3/8-16)w/ 14" WIRE	11
3	62-3468	ATT TAB ASSY, REM, SF/SB, 1 HOLE	2
4	102-7186	BREAKAWAY BRKT, BX2631	1
5	201-0418	8MM-1.25 X 35MM HEX BOLT, GRD. 8.8, ZP	1
6	201-0368	3/8-16 X 1 1/4 HEX HEAD BOLT, GRD. 5	11
7	201-0050	1/4-20 X 3/4 HEX BOLT, GRD. 5, ZP	2
8	203-0102	8MM LOCK WASHER, ZP	1
9	203-0010	3/8" LOCK WASHER, ZP	11
10	202-0069	1/4-20 HEX FLANGE WHIZ LOCK NUT, ZP	1
11	202-0102	1/4-20 HEX NYL NUT, ZP	1
12	202-0047	#10-32 HEX NUT	2
13	203-0054	#10 LOCK WASHER	2
14	101-5822	ADAPTER, 4 WAY CONNECTOR	2
15	201-0553	1/4-20 X 1/2" HEX WASHED, TYPE F, ZP	2
16	201-0192	#10-32-1/2" SLOT, ROUND HEAD SCREW	2

Parts Not Pictured:		
Qty.	Part #	Description
2	226-0046	Baseplate Safety Cables
2	229-0359	Quicklink, 3/8, ZP
2	290-0437	Cap Plug, Black

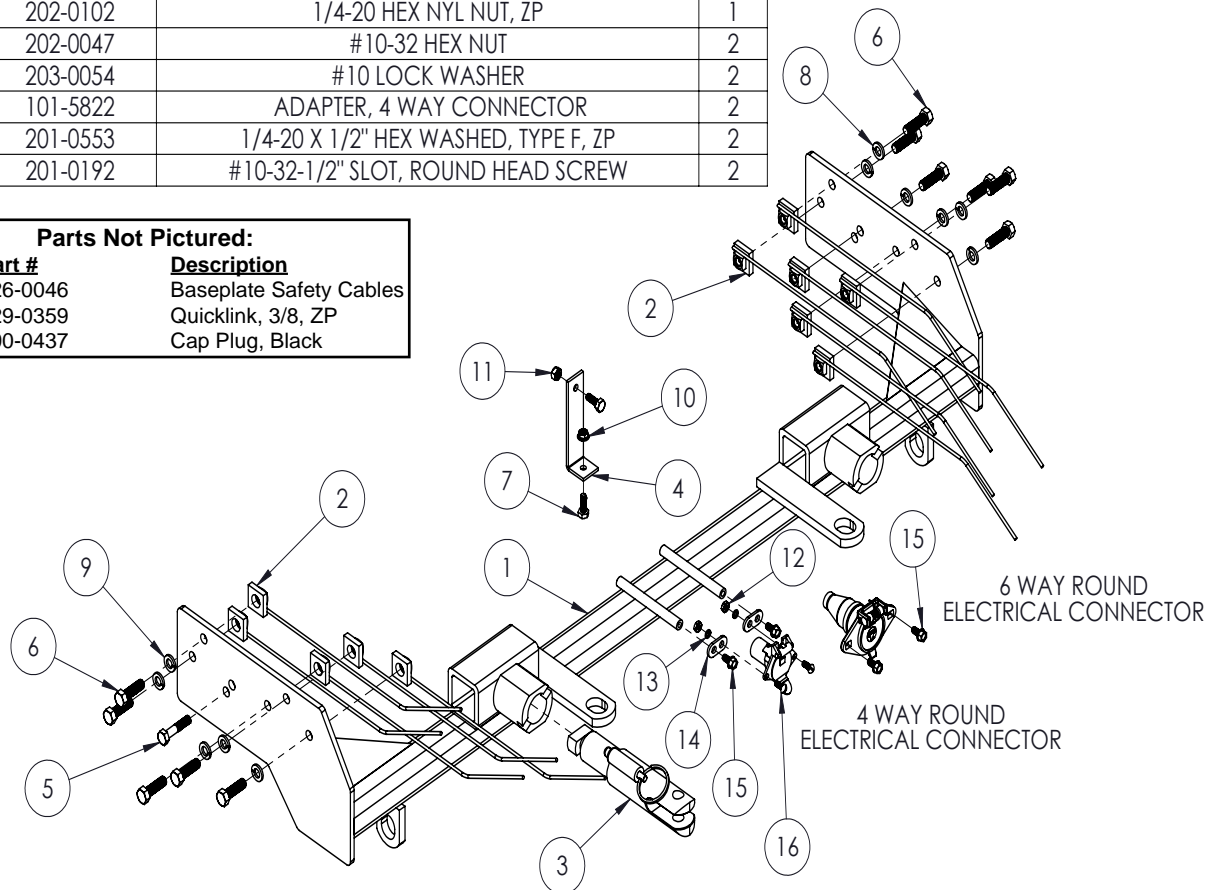

**Important:**

Use only genuine factory replacement parts on your baseplate. Do NOT substitute homemade or non-typical parts. If a bolt is lost or in need of replacement, for your safety and the preservation of your baseplate, be sure to use a replacement bolt of the same grade (In most cases it will be Grade 5, please reference the parts list above). Replacement parts may be ordered through your nearest Blue Ox® Dealer or Distributor, or call our Customer Care Team at (402)385-3051. Failing to follow and/or altering these installation instructions in either installation or required equipment will void the manufacturer's warranty.

# BX1995

## 2011-12 Mitsubishi Outlander Sport

### Installation Instructions

**Removable Tabs:** Motorhome mount tow bars are recommended for use with this baseplate. Due to the design of the removable tabs, the RangeFinderII, Acclaim, and Ambassador tow bars can not be used. Adapters, except the BX8833, BX88262 and BX88151, can not be used with this baseplate.

Tow Bar Adapters are NOT to be used with vehicle's weighing over 5,000 lbs.

**Instruction Notes:** The plastic radiator cover, fascia, and washer reservoir, are removed and reinstalled for the baseplate installation. Drilling is required. Trimming is required

The dimensional variations between otherwise identical vehicles can be considerable. While the baseplate was designed for easy installation, it may be necessary to tailor the baseplate slightly to compensate for auto manufacturer's tolerances. These minor adjustments may include filing a hole slightly, bending electrical rods or bending end plates.

The BX8848 4-Diode Wiring Kit is recommended for this vehicle.

**Do not use the towed vehicle for storing luggage, equipment, etc. This may cause you to exceed the towing capacity of the tow bar, baseplate, and its accessories.**

**Handling of some cosmetic parts when installing this product may require the use of protective covers, rags, specialty tools, etc. to prevent damage.**

#### Installation Instructions:

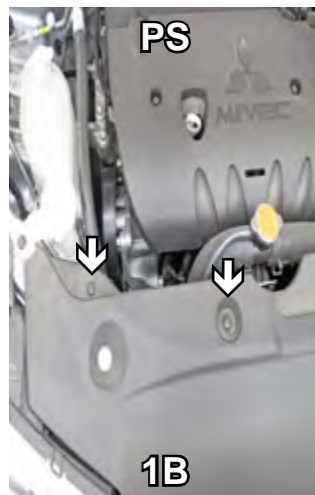

1. With flat screwdriver, remove six push pins from the top of the plastic radiator cover. Four are pictured between 1A and 1B. The remaining two push pins are pictured in 1C and 1D and are found at the inside point of each headlight. Remove plastic radiator cover and set aside with push pins to be reinstalled later.



# BX1995

## 2011-12 Mitsubishi Outlander Sport

### Installation Instructions

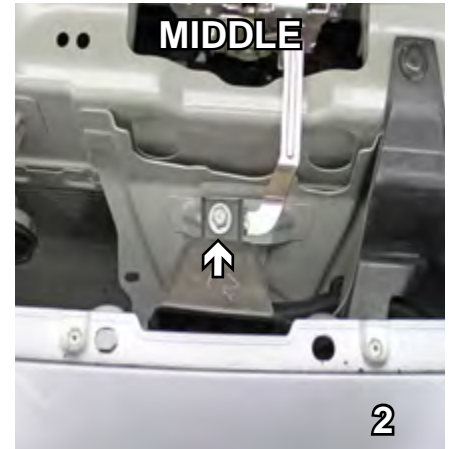
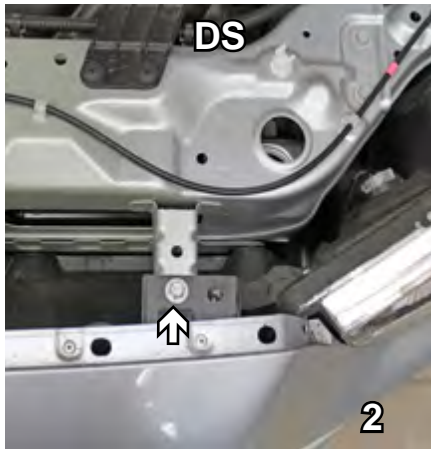

2. Using a 10MM socket remove three bolts from the top of the fascia.

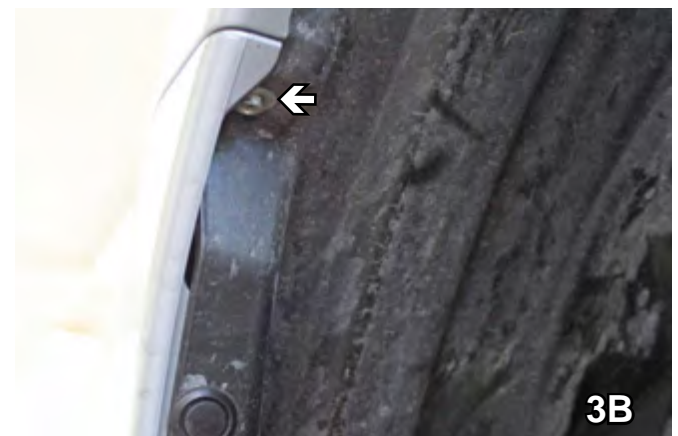

3. In front of the tire, remove three push pins with flat screwdriver as shown in 3A. Also in front of the tire, with an 8MM socket, remove 1 bolt (3B). Do this to both sides of the vehicle. Set push pins and bolts aside to be reinstalled later.

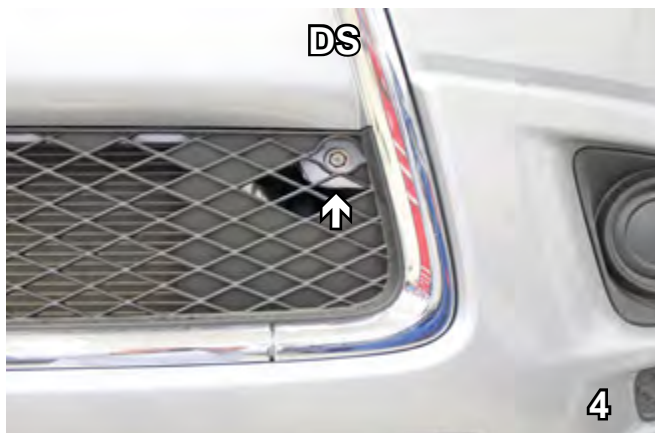

4. On the front of the fascia, with a 10MM socket, remove two bolts from the fascia webbing. Set bolts aside to be reinstalled later.

# BX1995

## 2011-12 Mitsubishi Outlander Sport

### Installation Instructions

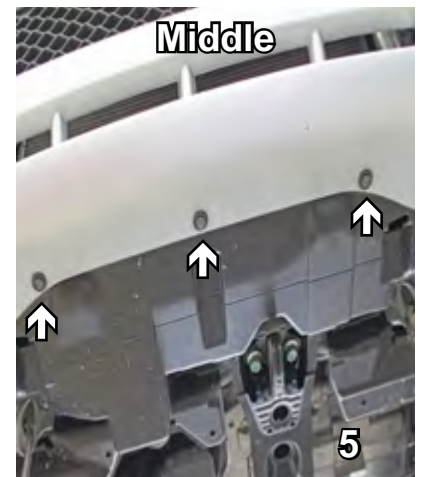
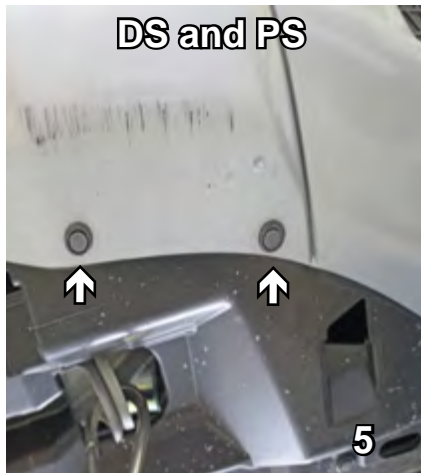

5. Underneath the fascia, remove 11 push pins with flat screwdriver. Set push pins aside to be reinstalled later.



6. To remove fascia, lift up and pull out between the front tire and headlight as shown in the above picture. Do this to both sides of the vehicle. Set fascia carefully aside to be reinstalled later.



7. On the passenger's side only, in order to remove the washer reservoir, remove one push pin inside the driver's side wheel well (7A) and two push pins underneath the washer reservoir (7B). The plastic can now be moved to the side when removing the washer reservoir. Set aside push pins to be reinstalled later.



# BX1995

## 2011-12 Mitsubishi Outlander Sport

### Installation Instructions

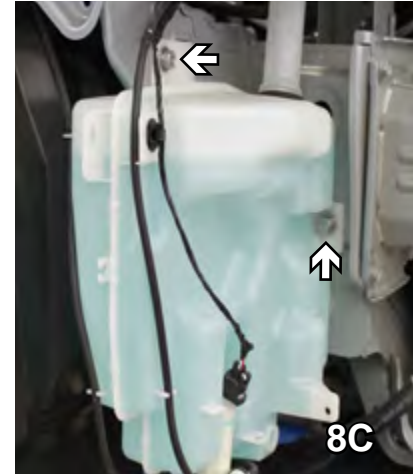
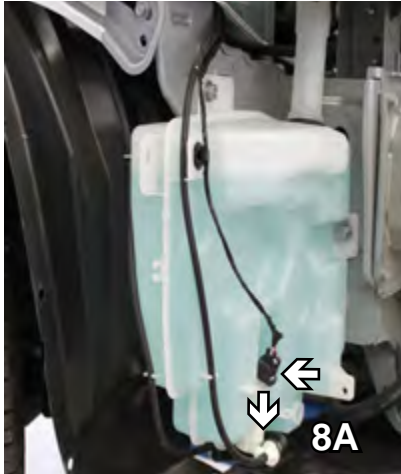

8. To remove washer reservoir on passenger's side, you must first unplug the electrical connections, disconnect and plug the fluid lines. (8A). Push aside plastic piece between washer reservoir and wheel well. Using a 12MM socket, remove one bolt from the back of the washer reservoir (8B). Remove additional two bolts on the front of the washer reservoir (8C). Carefully remove the washer reservoir and set aside with the bolts to be reinstalled later.

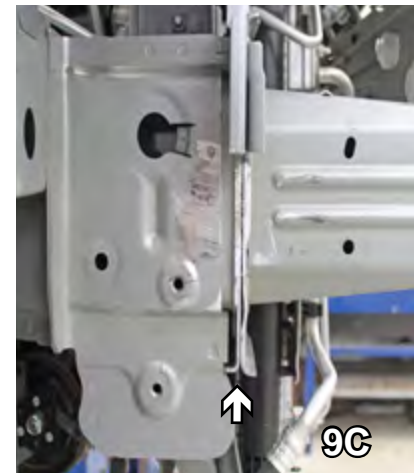
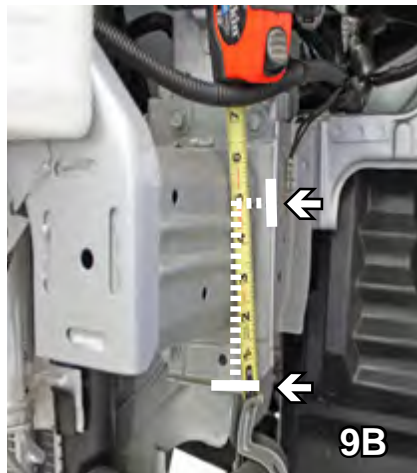
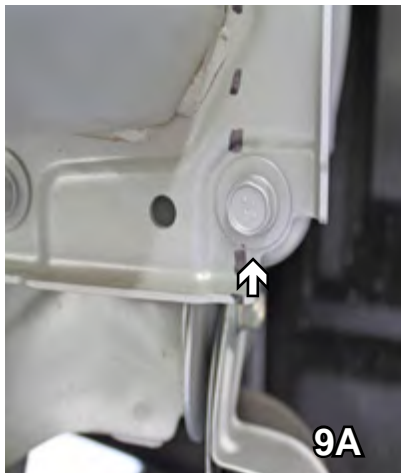

9. Trimming needs to be done on bumper horns. With 12MM socket, remove outer bottom bolt on the horn (9A). Measure 5" up from the bottom of the bumper horn and mark area flush with bumper horn to trim (9B). With a reciprocating saw, trim area flush with bumper horn. Complete these steps for both sides of the vehicle. Picture of completed trimming shown in 9C.

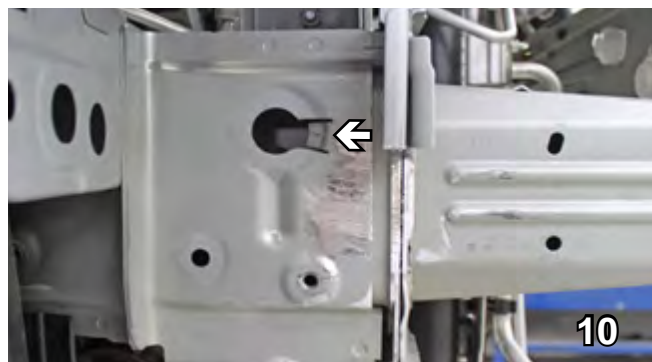

10. On the side of the framerail, with a reciprocating saw, make two horizontal cuts as shown above on existing hole (between 1" - 1 1/2" long). Trim additional metal from the area where the horizontal cuts were made. Do this to both sides. These openings will be used to insert the nut plates at a later point in the instructions.

# BX1995

## 2011-12 Mitsubishi Outlander Sport

### Installation Instructions

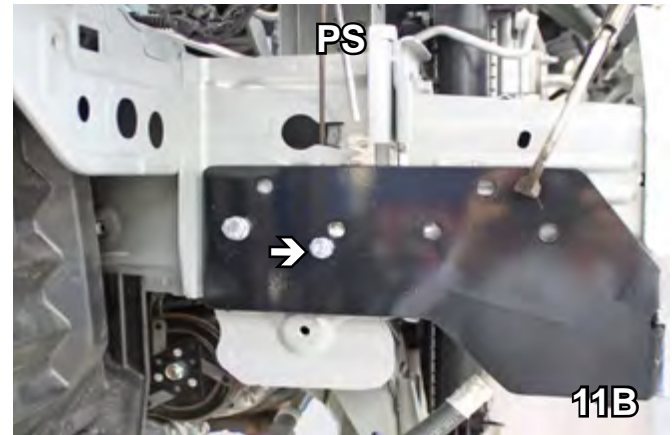
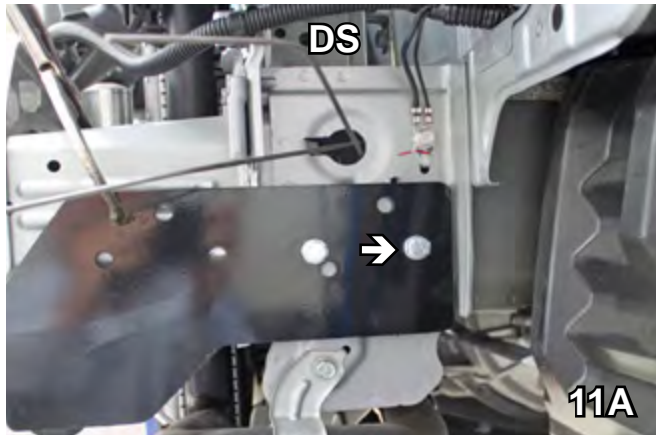

11. When mounting baseplate to the vehicle, use the existing holes on the siderails to align and keep level as shown above. Once you have confirmed baseplate is level and aligned with existing holes, clamp baseplate to frame rail on both sides with large vise grips. On driver's side, insert 3/8-16 x 1 1/4 hex head bolt with 3/8" lock washer and 3/8" nut plate into existing hole (11A). Tighten with Loctite Red. On passenger's side, insert 8MM-1.25 x 35MM hex bolt with 8MM lock washer into existing hole (11B). Do not tighten this bolt with Loctite Red. This bolt and lock washer will be removed and used when reinstalling the washer reservoir.

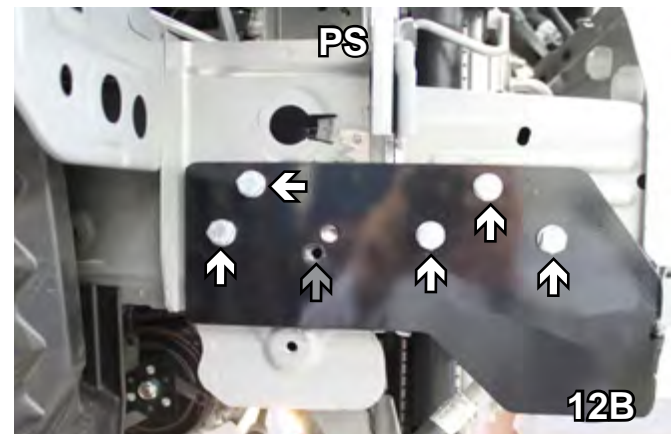
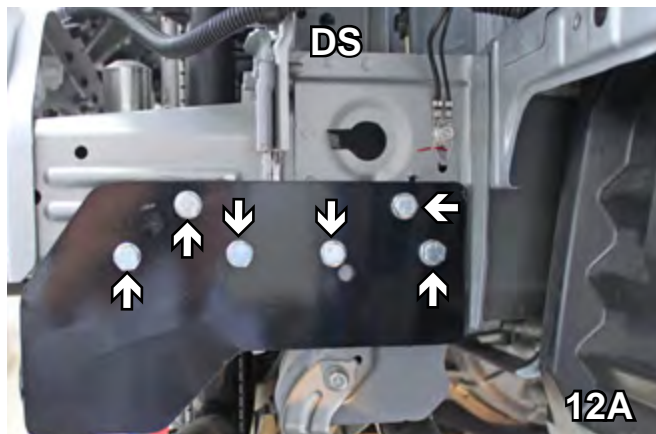

12. On driver's side, drill five holes with 13/32" drill bit (12A). Insert 3/8-16 x 1 1/4 hex head bolt, 3/8" lock washer and 1/4 x 1 x 1 nut plate. Tighten all bolts with Loctite Red. On passenger's side, drill five holes with same drill bit (12B). Insert 3/8-16 x 1 1/4 hex head bolt, 3/8" lock washer and 1/4 x 1 x 1 nut plate. Tighten with Loctite Red. NOTE: Not all holes will be drilled for the baseplate installation. On passenger's side, the 8MM-1.25 x 35MM hex bolt and lock washer that was previously inserted into baseplate and framerail need to be removed for washer reservoir reinstallation (gray arrow).

**When using power drills be aware of the dangers of torque and drill bit length.**

**BE SURE TO USE LOCTITE® RED ON ALL BOLTS BEFORE TIGHTENING. TIGHTEN ALL BOLTS ACCORDING TO THE TORQUE CHART ON THE FRONT PAGE OF THESE INSTRUCTIONS OR ON PAGE 3 OF THE BASEPLATE TOWING GENERAL INSTRUCTIONS.**



# BX1995

## 2011-12 Mitsubishi Outlander Sport

### Installation Instructions

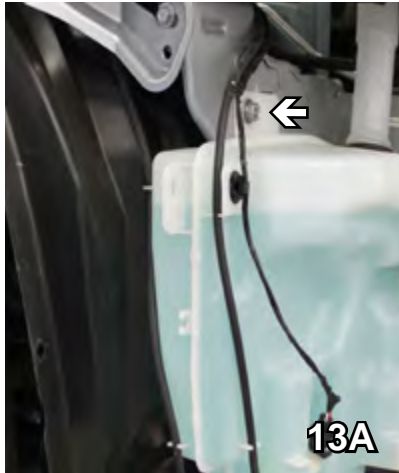

13. Reinstall washer reservoir on passenger's side. Use existing bolts referenced with white arrows in pictures 13A and 13B. Replace bolt shown in 13C with 8MM-1.25 x 35MM hex bolt and lock washer that was previously inserted into baseplate and framerrail. Reattach fluid lines and electrical connections.
14. Reinstall three push pins for the plastic cover on passenger's side between the wheel well and the washer reservoir (removal of push pins referenced previously in instruction #7).

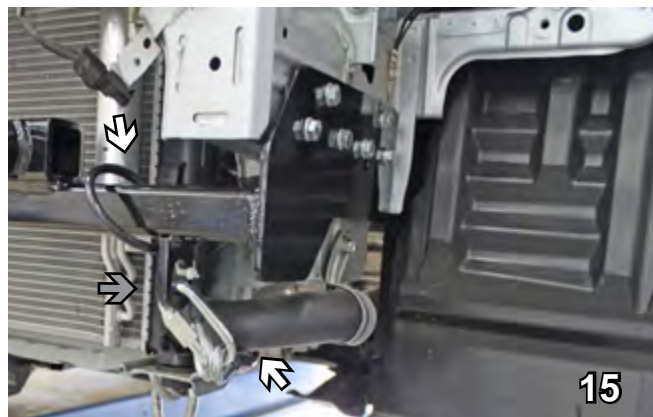

15. Attach the permanent baseplate safety cables to the provided convenience link on the baseplate (gray arrow). The photo above shows the recommended installation of the cables to frame of vehicle (white arrows). Additional options may interfere with suggested mounting; in this case secure the cables to a solid piece of the frame as described in the instructions included with the permanent baseplate safety cables. Be sure the safety cables do not rub against any hoses or moving parts. Do this to both sides of the vehicle.

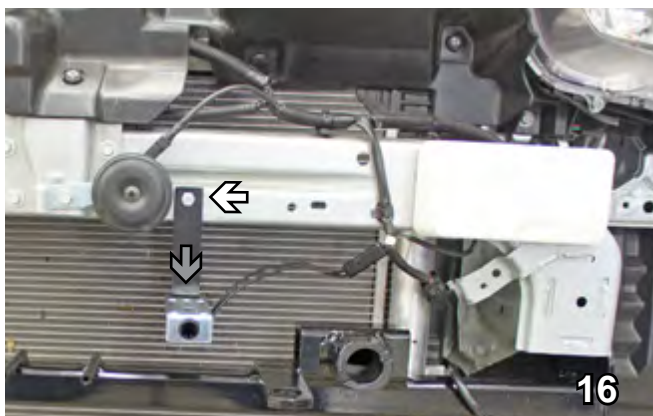

16. OPTIONAL: You can install the breakaway bracket and breakaway on either the driver's side or passenger's side of the vehicle. Drill 1/4 hole through the front of the bumper. Insert 1/4-20 x 3/4 hex bolt with 1/4-20 hex nyl nut to secure the bracket (white arrow). Attach breakaway to the bracket with 1/4-20 x 3/4 hex bolt with 1/4-20 whiz nut (gray arrow).



# BX1995

## 2011-12 Mitsubishi Outlander Sport

### Installation Instructions

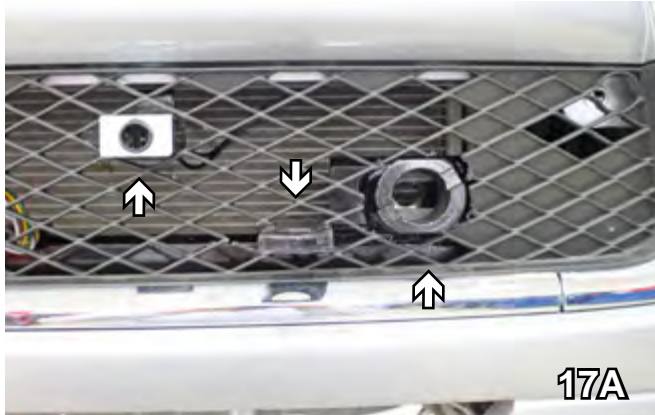

17. Hold fascia up as close to original position as possible. With a utility knife, trim fascia to allow baseplate attachment tabs, convenience links and breakaway, if applicable, to come through (17A). Example of completed trimming shown in 17B.

18. Reinstall plastic radiator cover and fascia.

Install the tow bar and safety cables according to the instructions provided in their packages. When demonstrating this to the customer, be sure to include all the contents and packages.

Do not substitute other devices if the tow bar pins and clips are misplaced.

**DEALER or INSTALLER:**  
**Be certain the user receives the  
instruction sheets for their products.**

Be sure that **ALL** electrical connections  
are plugged in properly and functioning  
**BEFORE** installing the fascia.

# BX1995

## 2011-12 Mitsubishi Outlander Sport

### Installation Instructions



**Shown with removable tabs installed**



**Shown without removable tabs installed**

### CUSTOMER SERVICE COMMITMENT

Blue Ox is committed to providing you with exceptional customer care throughout your lifetime with our products. Our team is here to assist you with any questions you may have regarding the performance of your product. Simply call (402) 385-3051 and you can speak with our customer care team.

Additionally, please visit our website to see which rallies our Destination America team will be attending. For a nominal fee, our service technician will service your towing system to ensure it's in proper working condition. Also, as a commitment to our customers, should you visit our factory, you can stay at our full service Blue Ox campground at no charge along with enjoying a factory tour.

Again, thank you for being our customer and for the confidence you have shown in the performance of our products. It is because of customers like you we enjoy the success we have today.

**If the baseplate is in an accident, it must be replaced. DO NOT use it again! An accident can cause unseen damage and using it again could result in more damage or serious injury. DO NOT use the baseplate if it is damaged or missing parts.**



© 2011 Blue Ox  
One Mill Road, Industrial Park  
Pender, Nebraska 68047  
Phone: (402) 385-3051  
Fax: (402) 385-3360  
[www.blueox.com](http://www.blueox.com)