



Baseplate Installation Instructions

BX2182 2006-09 Mercury Milan 2006-07 Ford Fusion Installation Instructions

Serial Number

Please read BOTH these Installation Instructions and the General Towing Instructions before attempting to install or operate this equipment.

- Blue Ox® towing products and accessories are intended to be installed by Blue Ox® Dealers who are familiar with our products and have the equipment and knowledge to do “fit work”. When necessary, Blue Ox® Dealers can be found at www.blueox.us or by contacting our Customer Care Department at (888) 425-5382
- Many Blue Ox® Baseplates are designed to use existing holes and hardware to mount the baseplate to the towed vehicle. Even though bolts are there, do not assume they are adequate for baseplate mounting. Always use hardware supplied in the hardware kit or existing hardware specified in the Baseplate Installation Instructions.

Attachment Tab Height: 13 1/2”
Attachment Tab Width: 22”

Bolt Torque Specifications

Torque in Foot-Pounds for Metric Bolts

Bolt Size	Grade 8.8	Grade 10.9
6MM	6	8
8MM	16	22
10MM	31	40
12MM	54	70
14MM	89	117

Confirm the towability and pre-towing procedures for your vehicle with the owner’s manual or contact the vehicle’s manufacturer for specific towing procedures.

Bolt Torque Specifications

Torque in Foot-Pounds for Inch Bolts

Bolt Size	Grade 5	Grade 8
1/4”	10	14
5/16”	19	29
3/8”	33	47
7/16”	54	78
1/2”	78	119
5/8”	154	230



! WARNING

Failure to read and follow these instructions could result in separation of the towed vehicle from the tow bar, causing property damage, loss of towed vehicle, personal injury or death.

BX2182
 2006-09 Mercury Milan
 2006-07 Ford Fusion
 Installation Instructions

Parts List

Ref. No.	Qty.	Part #	Description
1	1	61-6247	Weldment, Baseplate, BX2182
2	6	61-5208	3/8-16 Nut Plate, with 14" Wire
3	2	61-5558	1/2-13 Nut Plate, with 14" Wire
4	6	201-0440	3/8-16 x 1 1/2" Bolt, Grd. 5, ZP
5	6	203-0010	3/8" Lock Washer, ZP
6	2	201-0051	1/2-13 x 1 1/2" Bolt, Grd. 5, ZP
7	2	203-0012	1/2" Lock Washer, ZP
8	2	201-0553	1/4-20 x 1/2" Hx. Wshd, Type F Screw
9	2	201-0192	#10-32 x 1/2" Slot, Rd. Hd. Screw
10	2	203-0054	#10 Lock Washer
11	2	202-0047	#10-32 Hex Nut
12	2	101-5822	Adapter, 4 Way Connector
13	2	62-3468	Attachment, Assembly, SF/SB (R)
	2	226-0046	Baseplate Safety Cable, 36" CL III (Not Shown)
	4	229-0359	Quicklink, 3/8, ZP (Not Shown)
	2	290-0437	Cap Plug, Black (Not Shown)

Tools Required

Loctite® RED
 7mm Socket
 9/16" Socket
 17/32" Drill Bit
 Reciprocating Saw
 10mm Socket
 Vise Grips
 Utility Knife
 13mm Socket
 3/4" Socket
 13/32" Drill Bit
 25 Torx Socket
 Tape Measure
 Small Flat Screwdriver

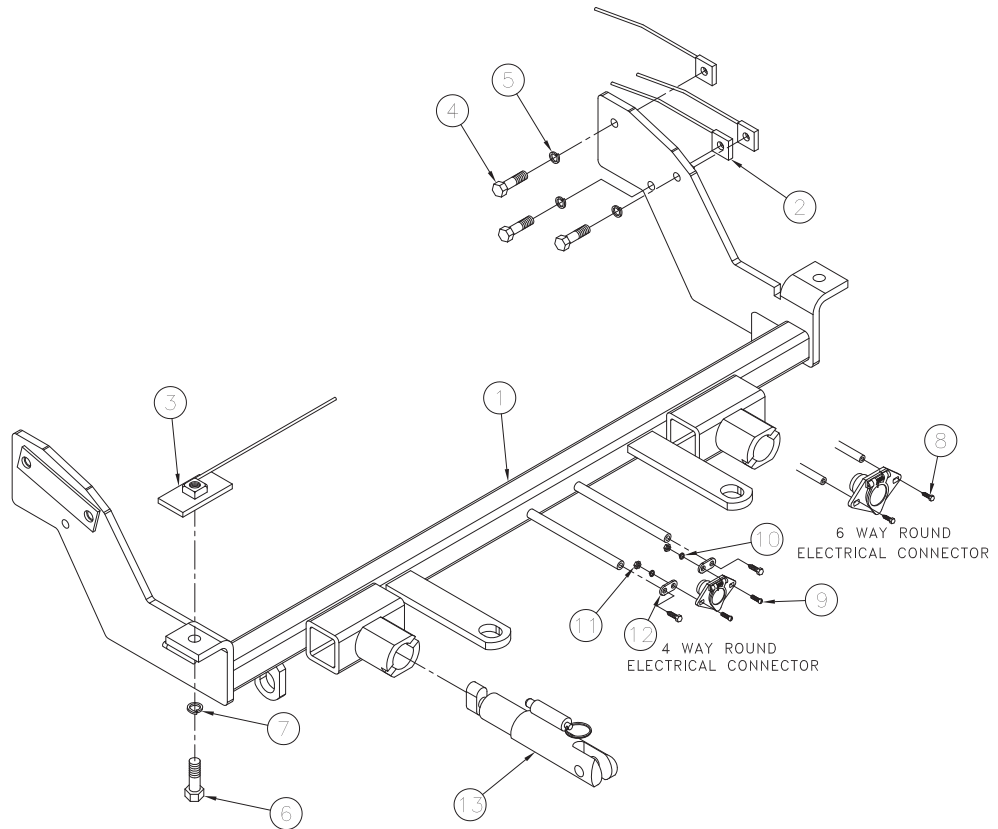

Important:

Use only genuine factory replacement parts on your baseplate. Do **NOT** substitute homemade or non-typical parts. If a bolt is lost or in need of replacement, for your safety and the preservation of your baseplate, be sure to use a replacement bolt of the same grade (In most cases it will be Grade 5, please reference the parts list above). Replacement parts may be ordered through your nearest Blue Ox® Dealer or Distributor.

BX2182
2006-09 Mercury Milan
2006-07 Ford Fusion

Installation Instructions

Attachment Tabs:

Motorhome mount tow bars are recommended for use with this baseplate. Due to the design of the removable tabs, the RangeFinderII, Adventurer and Ambassador tow bars can not be used. The Acclaim tow bar may be used, but will not fold and store on the front of the vehicle. Adapters, except the BX8833 and BX88151, can not be used with this baseplate.

Installation Notes: The front fascia, belly pan, metal bumper, plastic bumper cover, air dams, headlights, and fan modulator are removed for installation. Drilling is required. The grille must be trimmed. The air dams will not be reinstalled.

The dimensional variations between otherwise identical vehicles can be considerable. While the baseplate was designed for easy installation, it may be necessary to tailor the baseplate slightly to compensate for auto manufacturer's tolerances. These minor adjustments may include filing a hole slightly, bending electrical rods, and/ or bending end plates.

The BX8848 Diode Wiring Kit is recommended for this vehicle.

Installation Instructions:



1. Using the 10mm socket, remove two metric bolts from the top corners of the grille (see grey arrows). Remove two pushpins from the top of the grille (see white arrows). Set pushpins and bolts aside to be reinstalled later.



2. Just forward of the front tire, inside the wheel well, remove three pushpins. Do this to both sides of the vehicle. Set pushpins aside to be reinstalled later.

BX2182
2006-09 Mercury Milan
2006-07 Ford Fusion
Installation Instructions



3. Using the 7mm socket, remove three metric bolts from the bottom edge of the fascia just forward of the front tire (see grey arrows) and one metric bolt from the back edge of the bellypan (see white arrow). Do this to both sides of the vehicle. Set bolts aside to be reinstalled later.



4. Using the 7mm socket, remove four metric bolts from underneath the center of the fascia. Set bolts aside to be reinstalled later.

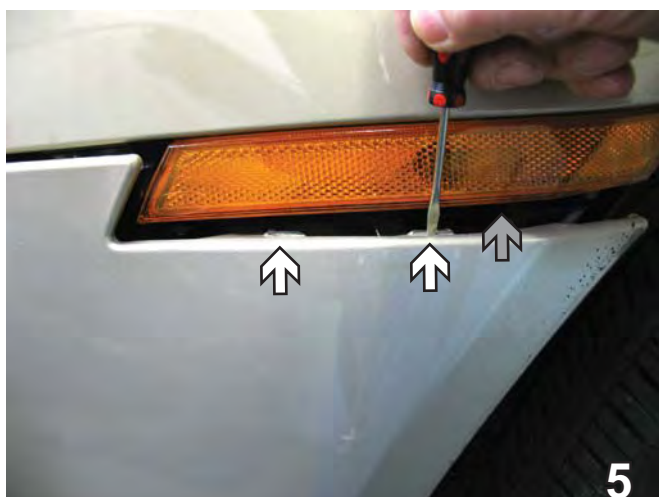

5. Pull out on the fascia corner, below the turn signal marker. Using a small flat screwdriver, push up to release one clip under the turn signal (see grey arrow). Release two tabs under the turn signal (see white arrows)



6. Release two tabs from the front fascia, between the turn signal marker and the headlight (see white arrows) and one eyelet, just behind the headlight (see grey arrow). Do this to both sides of the vehicle. Pull fascia forward to remove. Set fascia aside to be reinstalled later.

BX2182
2006-09 Mercury Milan
2006-07 Ford Fusion
Installation Instructions

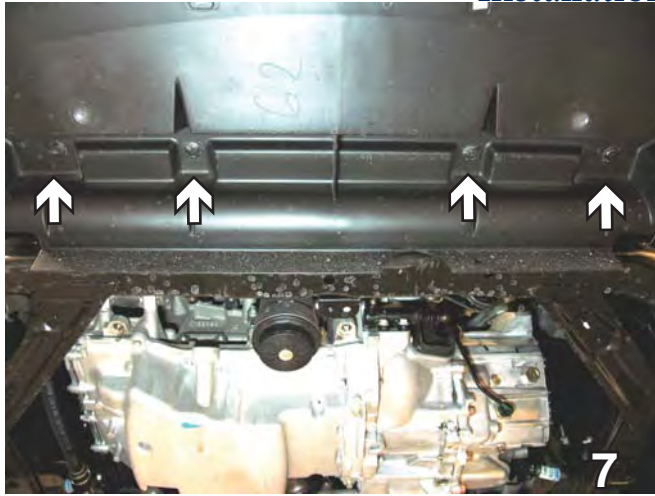

7. Remove four pushpins from the bottom of the bellypan. Pull belly pan down to remove. Set pushpins and belly pan aside to be reinstalled later.



8. Using the 13mm socket, remove four metric bolts from the bumper bracket, two on the top and two on the bottom (see white arrows). Using the 10mm socket, remove two metric bolts from the side of the bumper bracket (see grey arrows). Do this to both sides of the vehicle. Pull the metal bumper forward to remove. Set bolts and metal bumper aside to be reinstalled later.



9. Mark the rectangular area on the frame rail end cap, 1/2" from the inside edge and up 4" from the bottom of the frame rail. Trim away the area using the reciprocating saw. This will clear the area for baseplate installation.



10. Using the 10mm socket, remove the metric bolt securing the air dam to the radiator support. Do this to both sides of the vehicle. Discard the bolts and air dams as they will not be reinstalled.

BX2182
2006-09 Mercury Milan
2006-07 Ford Fusion
Installation Instructions



11. Remove the plastic from the front of the metal bumper by releasing the plastic from the slotted clips. On the back side of the metal bumper bracket, measure and mark a rectangle, 3 3/4" from the top of the bumper bracket 3 1/4" in from the outside edge of the bumper and 3/4" wide. *Note: To make cutting easier, flip the metal bumper over as shown in the photo above. Driver's side is shown in the photo.*



12. Using the reciprocating saw, start both vertical cuts and continue until reaching the top side of the bumper bracket support. Using the vise grips, bend the cut metal back and forth until it pulls away. Do this to both sides of the metal bumper. Driver's side is shown in the photo.



13. Using the reciprocating saw, cut from the outside edge of the bumper bracket's vertical cut, toward the front of the bumper 2" and then across to the inside edge of bumper bracket. Cut along the bumper bracket support contour to the bumper bracket. Finally, complete cutting the rectangular area shown in step 12. Do this to both sides of the metal bumper. Driver's side is shown in the photo.



14. On the bottom side of the bumper plastic, measure and mark a rectangle 2 1/2" wide on the raised molding 2 1/4" from the outside edge of the plastic and 1 1/4" high. Trim away the area with the utility knife to open for baseplate installation. Do this to both sides of the plastic. Driver's side is shown in the photo

BX2182
2006-09 Mercury Milan
2006-07 Ford Fusion
Installation Instructions



15. Using the 10mm socket, remove three metric bolts from the headlight assembly (see white arrows). Remove one pushpin from the headlight assembly's upper, outside edge (see grey arrow). Do this to both sides of the vehicle. Set bolts and pushpins aside to be reinstalled later.



16. Using the 10mm socket, remove one metric bolt from the fender, just forward of the turn signal marker. Disconnect electrical and pull headlight forward to remove. Do this to both sides of the vehicle. Set bolts and headlight assemblies aside to be reinstalled later.

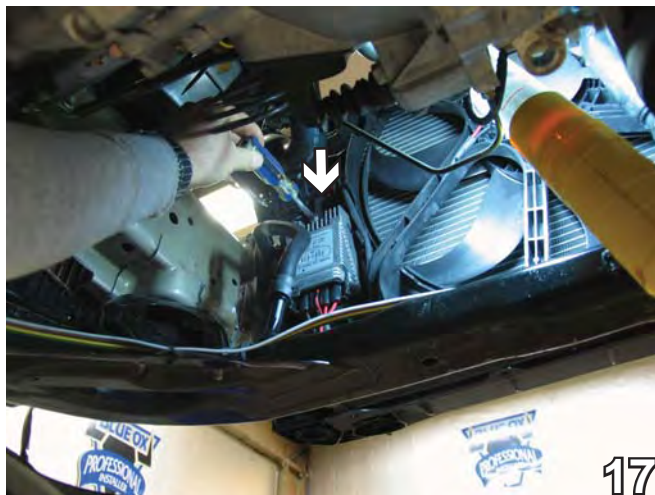

17. Using the 25 Torx socket, remove the bolt in the cut away area above the fan modulator, behind the radiator on the driver's side. Move the fan modulator out of the way to clear the area for baseplate drilling. Set bolt aside to be reinstalled later.



18. Reinstall the metal bumper. Install only two bolts on each side to hold the bumper in place because it will be removed again. It is not necessary to insert the plastic to the front of the bumper at this time.

BX2182
2006-09 Mercury Milan
2006-07 Ford Fusion
Installation Instructions



19. Slide the baseplate up through notches in the bumper bracket until flush with the bottom of the metal bumper. Insure the endplates are against the inside of frame rail above the suspension ridge (see white arrow) and the attachment tabs are level. Clamp baseplate in place with the large vise grips. Using the baseplate as a template, drill three holes into the frame rail with the 13/32" drill bit. Insert the 3/8-16 x 1 1/2" bolts and 3/8" lock washers to hold the baseplate in place. Do this to both sides of the vehicle. *Note: On passenger's side, using a drill bit shield to protect the vehicle's hoses is recommended.*

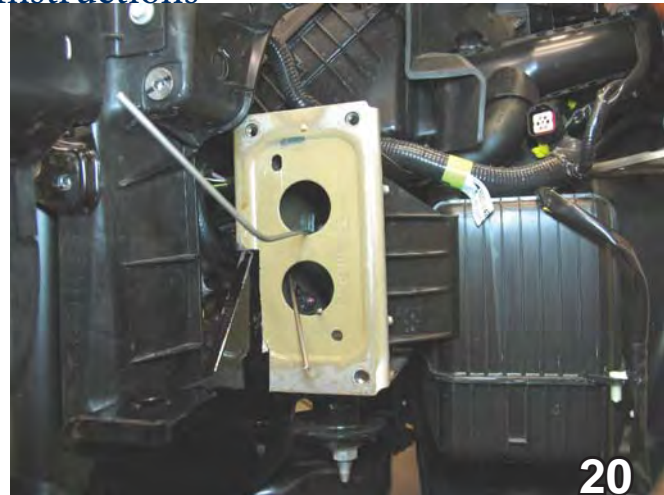

20. Remove the metal bumper. Insert the 3/8-16 nut plates into the frame rail to align with the 3/8-16 x 1 1/2" bolts and tighten with the 9/16" socket. Do this to both sides of the vehicle. Remove the vise grips.

BE SURE TO USE LOCTITE® RED ON ALL BOLTS BEFORE TIGHTENING. TIGHTEN ALL BOLTS ACCORDING TO THE TORQUE CHART ON THE FRONT PAGE OF THESE INSTRUCTIONS OR ON PAGE 3 OF THE BASEPLATE TOWING GENERAL INSTRUCTIONS.



21. Reinstall metal bumper and plastic cover. Tighten all bolts completely. *Note: Due to the trimming of the bumper brackets, there will be one less 10mm bolt installed on the bottom of each bumper bracket.*

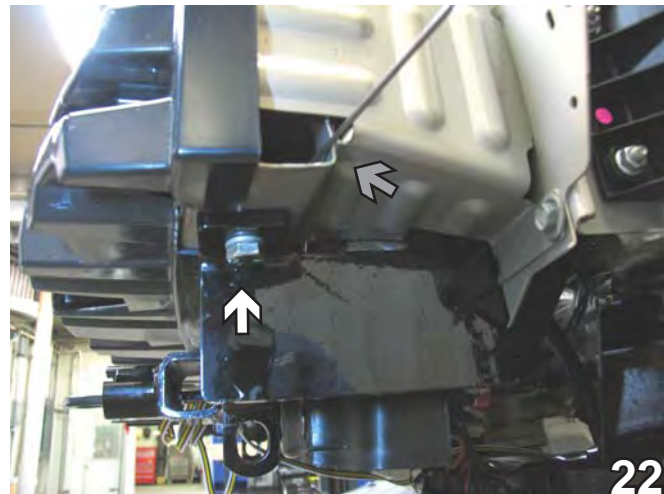

22. Using the baseplate as a template, drill into the bottom of the metal bumper using the 17/32" drill bit. Insert the 1/2-13 x 1 1/2" bolt and 1/2" lock washer (see white arrow). Insert 1/2-13 nut plate (see grey arrow) and tighten to the bolt with the 3/4" socket. Do this to both sides of the vehicle.

BX2182
2006-09 Mercury Milan
2006-07 Ford Fusion
Installation Instructions

22. Reinstall headlights, fan modulator and bellypan. Insure all pushpins, bolts, and electrical connections are installed.

Be sure that **ALL** electrical connections are plugged in properly and functioning **BEFORE** installing the fascia.



23. Hold the fascia up to its original location, mark and trim the grille with the utility knife as necessary for the attachment tabs to come through. The convenience links will come through the second opening from the top of grille and the electrical rods through the third opening from the top. Reinstall the fascia.

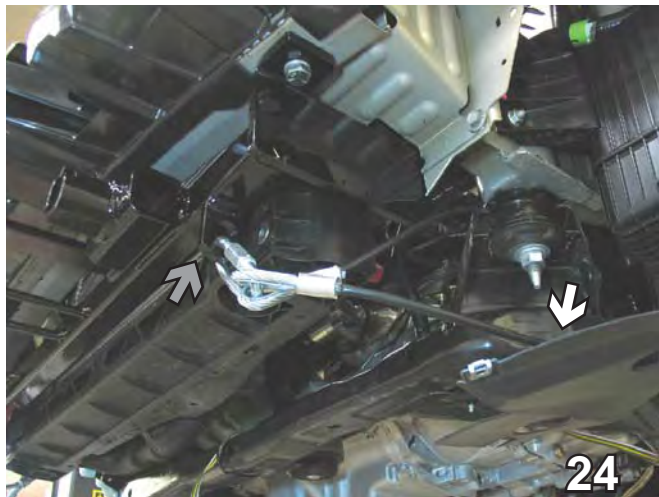

24. Attach the permanent baseplate safety cables to the provided convenience link on the baseplate (see grey arrow). The photo above shows the recommended installation of the permanent baseplate safety cables to frame of the vehicle (see white arrow). If the vehicle has additional options, not shown above, which interfere with mounting the permanent baseplate safety cables, secure the cable to a solid piece of the vehicle's frame as described in the instructions included with the permanent baseplate safety cables.

DEALER or INSTALLER:
Be certain the user receives the instruction sheets for their products.

Install the tow bar and safety cables according to the instructions provided in their packages. When demonstrating this to the customer, be sure to include all the contents and packages.

Do **NOT** substitute other devices if the tow bar pins and clips are misplaced.

BX2182
2006-09 Mercury Milan
2006-07 Ford Fusion
Installation Instructions

CUSTOMER SERVICE COMMITMENT

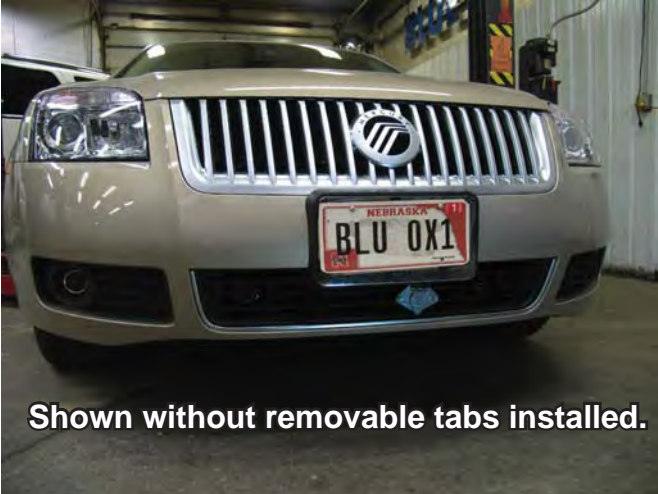

Blue Ox is committed to providing you with exceptional customer care throughout your lifetime with our products. Our team is here to assist you with any questions you may have regarding the performance of your product. Simply call 1-800-228-9289 and you can speak with our customer care team.

Additionally, please visit our website to see which rallies our Destination America team will be attending. For a nominal fee, our service technician will service your towing system to ensure it's in proper working condition. Also as a commitment to our customers, should you visit our factory you can stay at our full service Blue Ox campground at no charge along with enjoying a factory tour.

Again thank you for being our customer and for the confidence you have shown in the performance of our products. It is because of customers like you we enjoy the success we have today.

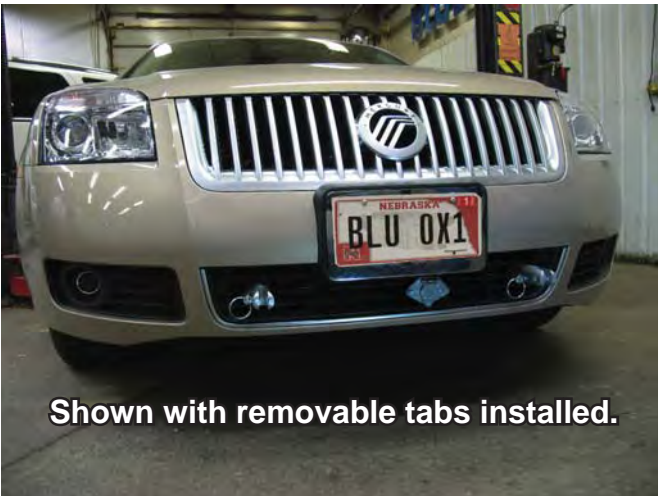

If the baseplate is in an accident, it must be replaced. **DO NOT** use it again! An accident can cause unseen damage and using it again could result in more damage or serious injury. **DO NOT** use the baseplate if it is damaged or missing parts.



© 2006, 07, 08, 09 Blue Ox
One Mill Road, Industrial Park
Pender, Nebraska 68047
Phone: (402) 385-3051 • Fax: (402) 385-3360
www.blueox.us