



Baseplate Installation Instructions

BX2184 2005-07 Ford Focus Includes Foglights Installation Instructions

Serial Number

Please read BOTH these Installation Instructions and the General Towing Instructions before attempting to install or operate this equipment.

- Blue Ox® towing products and accessories are intended to be installed by Blue Ox® Dealers who are familiar with our products and have the equipment and knowledge to do "fit work". When necessary, Blue Ox® Dealers can be found at www.blueox.com or by contacting our Customer Care Department at (402) 385-3051.
- Many Blue Ox® Baseplates are designed to use existing holes and hardware to mount the baseplate to the towed vehicle. Even though bolts are there, do not assume they are equate for baseplate mounting. Always use hardware supplied in the hardware kit or existing hardware specified in the Baseplate Installation Instructions.

Attachment Tab Height: 13"

Attachment Tab Width: 18"

Bolt Torque Specifications
Torque in Foot-Pounds for Metric Bolts

Bolt Size	Grade 8.8	Grade 10.9
6MM	6	8
8MM	16	22
10MM	31	40
12MM	54	70
14MM	89	117

Confirm the towability and pre-towing procedures for your vehicle with the owner's manual or contact the vehicle's manufacturer for specific towing procedures.

Bolt Torque Specifications
Torque in Foot-Pounds for Inch Bolts

Bolt Size	Grade 5	Grade 8
1/4"	10	14
5/16"	19	29
3/8"	33	47
7/16"	54	78
1/2"	78	119
5/8"	154	230



If the front of your vehicle looks different than this, call us at (402) 385-3051.

! WARNING

Failure to read and follow these instructions could result in separation of the towed vehicle from the tow bar, causing property damage, loss of towed vehicle, personal injury or death.

BX2184

2005-07 Ford Focus (Includes Foglights)

Installation Instructions

Parts List

Ref. No.	Qty.	Part #	Description
1	1	61-6297	Weldment, Baseplate, BX2184
2	8	201-0368	3/8-16 x 1 1/4" Bolt, Grd. 5, ZP
3	8	203-0010	3/8" Lock Washer, ZP
4	8	202-0003	3/8-16 Hex Nut
5	1	201-0071	1/4-20 x 1" Hex Bolt, Grd. 5, ZP
6	1	203-0001	1/4" Flat Washer
7	1	203-0008	1/4" Lock Washer
8	1	202-0001	1/4-20 Hex Nut, ZP
9	2	201-0553	1/4-20 x 1/2" Hx. Wshd. Type F TCS, ZP
10	2	201-0192	10-32 x 1/2" Slot, Rd. Hd. Screw
11	2	203-0054	#10 Lock Washer
12	2	202-0047	#10-32 Hex Nut
13	2	101-5822	Adapter, 4 Way Connector
14	2	62-3468	Attachment, Assembly, SF/SB (R)
	2	226-0046	Baseplate Safety Cable, 36" CL III (Not Shown)
	2	229-0359	Quicklink, 3/8, ZP (Not Shown)
	2	290-0437	Receiver Cap Plug, Black (Not Shown)

Tools Required

6mm Socket	13/32" Drill Bit
7mm Socket	30 Torx Socket
8mm Socket	Phillips Screwdriver
10mm Socket	Flat Screwdriver
7/16" Socket	Vise Grips
9/16" Socket	Utility Knife
Loctite® RED	

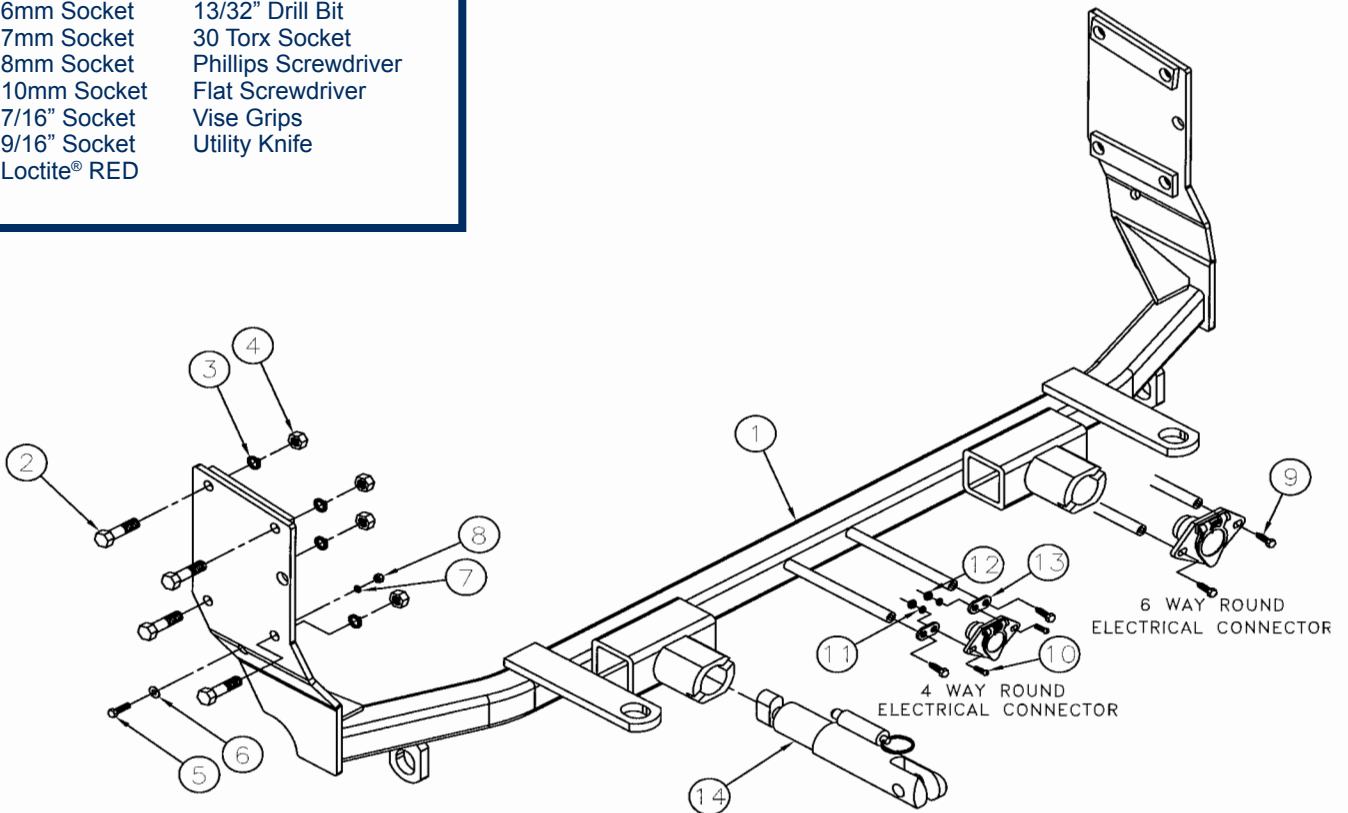

Important:

Use only genuine factory replacement parts on your baseplate. Do **NOT** substitute homemade or non-typical parts. If a bolt is lost or in need of replacement, for your safety and the preservation of your baseplate, be sure to use a replacement bolt of the same grade (In most cases it will be Grade 5, please reference the parts list above). Replacement parts may be ordered through your nearest Blue Ox® Dealer or Distributor. Failing to follow and/or altering these installation instructions in either installation or required equipment will void the manufacturer's warranty. Towing behind a non-motorized vehicle will void the warranty.

BX2184

2005-07 Ford Focus (Includes Foglights) Installation Instructions

Attachment Tabs: Motorhome mount tow bars are recommended for use with this baseplate. Due to the design of the removable tabs, the RangeFinderII, Adventurer, and Ambassador tow bars can not be used. The Acclaim tow bar may be used, but will not fold and store on the front of the vehicle. Adapters, except the BX8833 and BX88151, can not be used with this baseplate.

Installation Notes: The radiator cover, grille assembly, belly pan, fascia, coolant line bracket on passenger's side, air baffle and air dams are removed for installation. Reinstallation of the air dams is optional. If air dams are reinstalled, trimming of the air dams is required. Drilling is required.

The dimensional variations between otherwise identical vehicles can be considerable. While the baseplate was designed for easy installation, it may be necessary to tailor the baseplate slightly to compensate for auto manufacturer's tolerances. These minor adjustments may include filing a hole slightly, bending electrical rods or bending end plates.

The BX8869 Bulb and Socket Wiring Kit is recommended for this vehicle.



Possible location for the Bulb and Socket Wiring Kit (BX8869)

Installation Instructions:

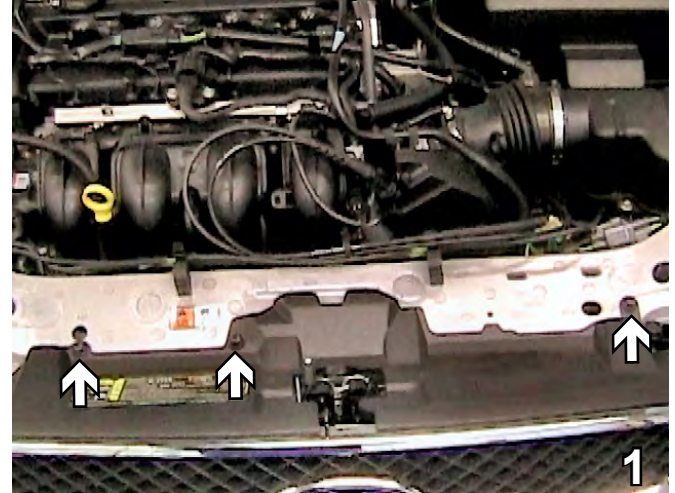

1. Remove three Phillips pushpins from radiator cover and lift to remove. Set pushpins and radiator cover aside to be reinstalled later.

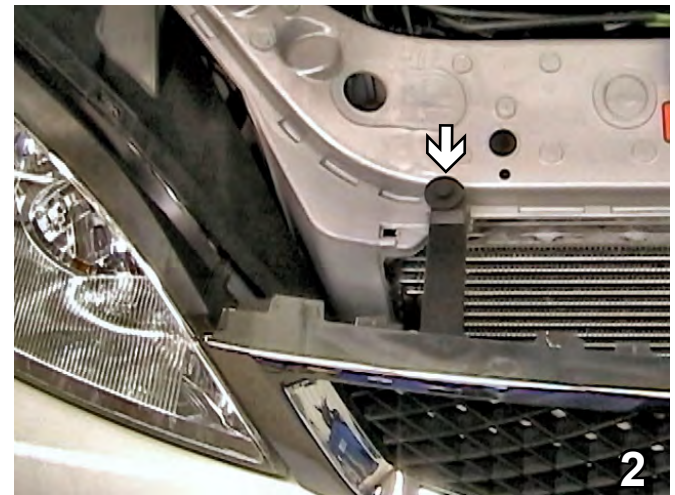

2. Using the 10mm socket, remove one metric bolt from upper grill assembly. Do this to both sides of the vehicle. Lift assembly to remove. Set bolts and grille assembly aside to be reinstalled later.

Handling of some cosmetic parts when installing this product may require the use of protective covers, rags, specialty tools, etc. to prevent damage.

Do not use the towed vehicle for storing luggage, equipment, etc. This may cause you to exceed the towing capacity of the tow bar, baseplate, and its accessories.

BX2184

2005-07 Ford Focus (Includes Foglights) Installation Instructions

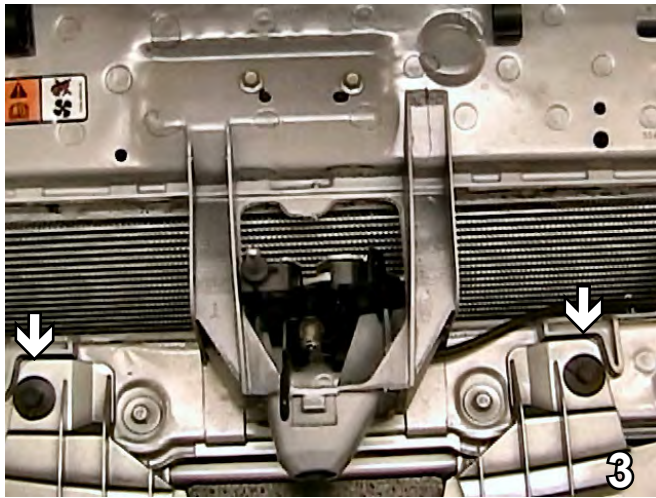

3. Remove one push pin from top of fascia on each side of hood latch. Set pushpins aside to be reinstalled later.



4. Remove one bolt just forward of the front tire, on the edge of fascia, using the 30 Torx socket (see white arrow). Remove one metric bolt from the wheel well using the 7mm socket (see grey arrow). Do this to both sides of the vehicle. Set bolts aside to be reinstalled later.



5. Remove one Phillips screw from edge of fascia, just inside wheel well. Do this to both sides of the vehicle. Set screws aside to be reinstalled later. (Some models may have this.)

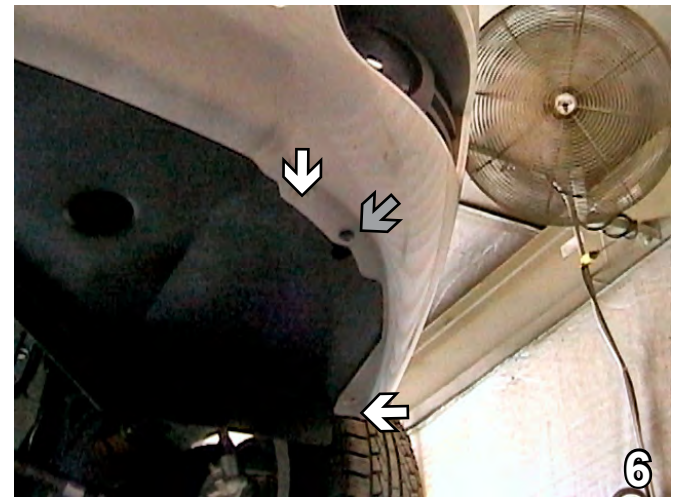

6. Using the 7mm socket, remove three metric bolts from the bottom corner of fascia - two silver (see white arrows) and one black (see grey arrow). Do this to both sides of the vehicle. Set bolts aside to be reinstalled later.

BX2184
2005-07 Ford Focus (Includes Foglights)
Installation Instructions



7. Using the 7mm socket, remove two metric bolts from the bottom center of fascia. Set bolts aside to be reinstalled later.

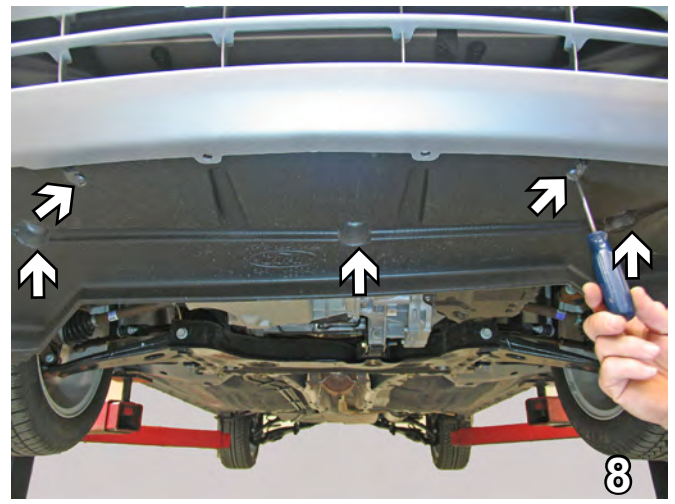

8. Remove five Phillips pushpins from the bottom of the belly pan. Set pushpins and belly pan aside to be reinstalled later.

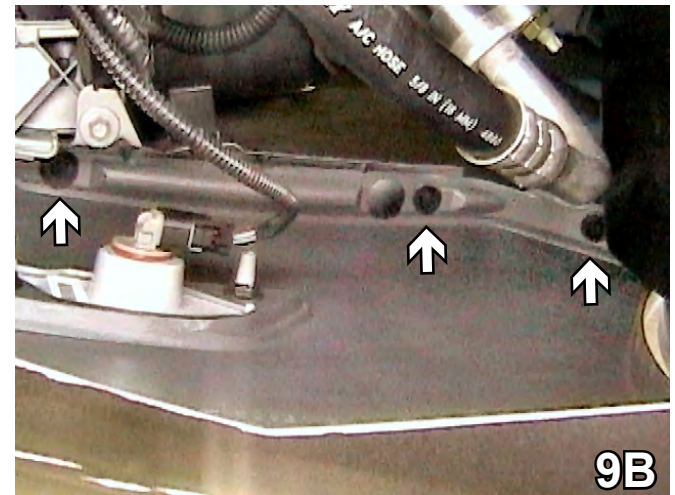

11. Pull wheel well cover aside and remove three metric bolts from back side of fascia using the 10mm socket. Do this to both sides of the vehicle. Pull fascia forward to remove. Set bolts and fascia aside carefully to be reinstalled later.

BX2184
2005-07 Ford Focus (Includes Foglights)
Installation Instructions

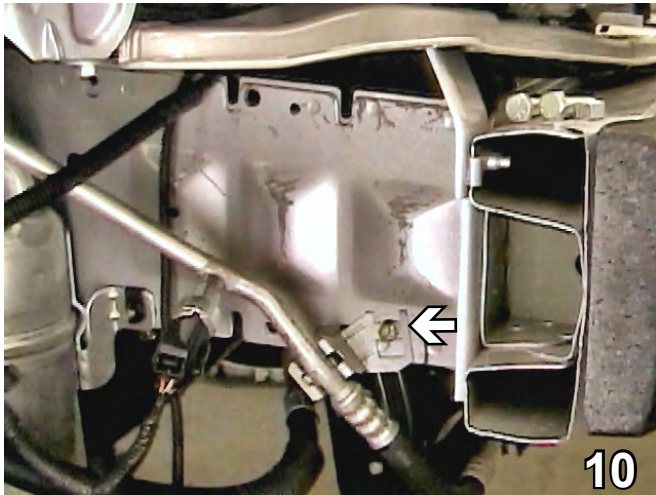

10. On passenger's side, flatten the tabs around the lower coolant line bracket. Using the 10mm socket, remove one metric bolt from the bracket. Set bracket aside to be reinstalled later (a new bolt is provided for reinstallation). Follow coolant line up to fender well and release from the upper bracket. Move coolant line out of the way. *Note: Some models may have a low emission pump on passenger's side frame. Lift from top of the frame and move out of the way.*

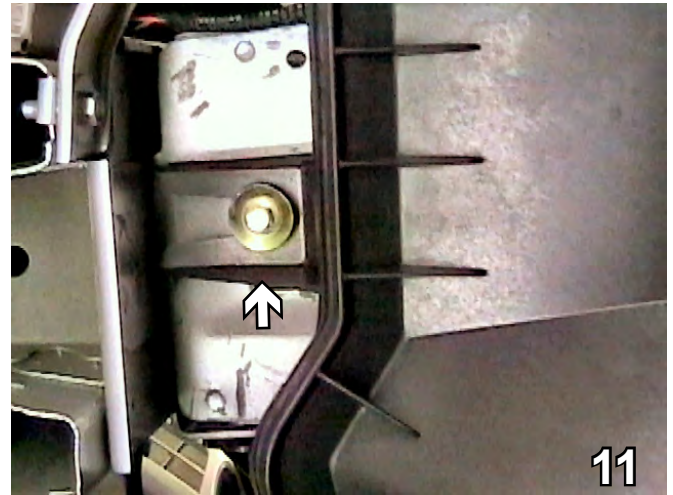

11. On the driver's side, behind the metal bumper, use the 8mm socket to remove one metric bolt from the air baffle. Set bolt aside to be reinstalled later.

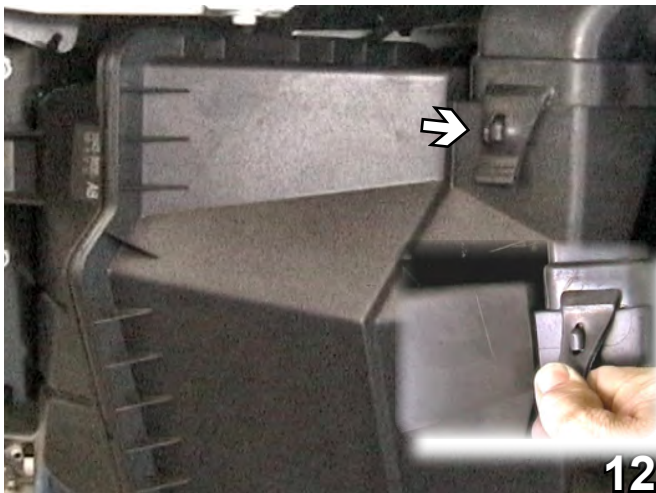

12. Pull the front tab of the air baffle down and forward to release.

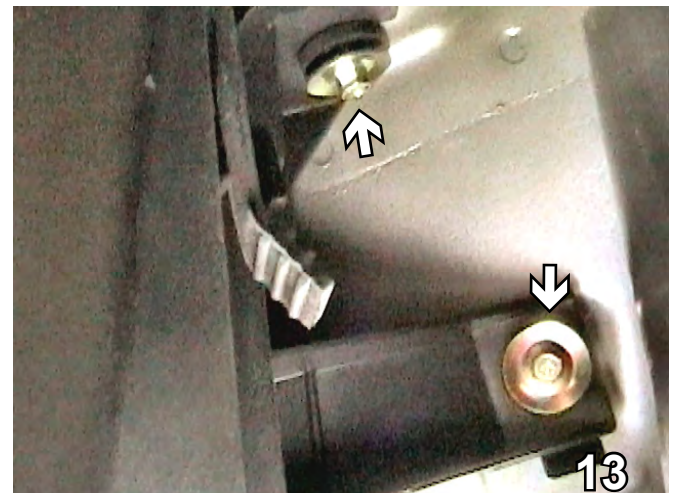

13. Between the back side of the air baffle and the wheel well, use the 8mm socket to remove two metric bolts. Set bolts aside to be reinstalled later.

BX2184
2005-07 Ford Focus (Includes Foglights)
Installation Instructions



14 Using the 6mm socket, loosen the air baffle clamp. Disconnect electrical connection. Pull air baffle down and set aside.

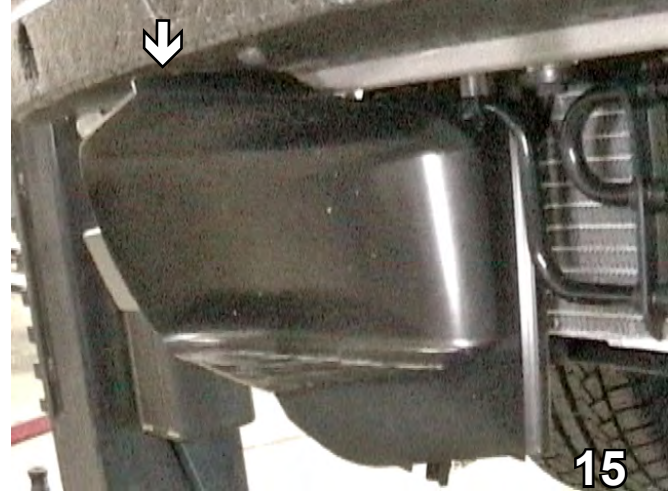

15. Follow the air dam plastic (shown in photo) to above the metal bumper and use the flat screwdriver to remove two pushpins. Pull air dam forward to remove. Do this to both sides of the vehicle. Set air dams and pushpins aside to be reinstalled later.



16. Slide the baseplate onto the frame rails 1 1/2" back from the bumper bracket aligning the front air baffle hole with the front middle hole of the baseplate. Align the top edge of the endplate with the top edge of the frame rail and clamp in place using the large vise grips. Hold the fascia up to its original position and verify the convenience links, electrical rods and attachment tabs come through the fascia opening.

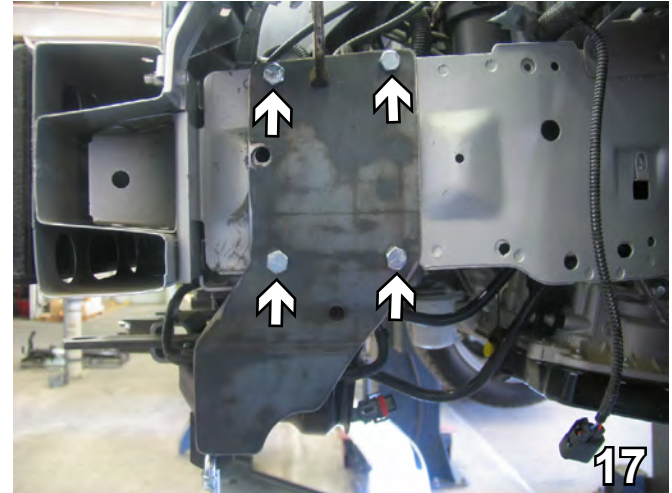

17. Using the baseplate as a template, drill four corner holes into the frame webbing with the 13/32" drill bit. Insert 3/8"-16 x 1 1/4" hex bolts into holes and tighten to the 1/4" lock washers and 3/8-16 hex nuts.

When using power drills be aware of the dangers of torque and drill bit length.

BX2184

2005-07 Ford Focus (Includes Foglights) Installation Instructions



18. On the passenger's side, reinstall coolant bracket to lower endplate hole. Put 1/4" flat washer on the 1/4-20 x 1" hex bolt and insert into hole and tighten to the 1/4" lock washer and 1/4-20 hex nut using the 7/16" socket. Do not attach the coolant line to the top bracket if it causes the line to rub against the baseplate. Models with a low emission device need to reposition the device with a wire tie.



19. Reinstall air baffle to middle endplate hole on driver's side with the existing bolts and clamp. If necessary, remove the rubber grommet from the bolt (see white arrow) to it to tighten properly.

Be sure that **ALL** electrical connections are plugged in properly and functioning **BEFORE** installing the fascia.

BE SURE TO USE LOCTITE® RED ON ALL BOLTS BEFORE TIGHTENING. TIGHTEN ALL BOLTS ACCORDING TO THE TORQUE CHART ON THE FRONT PAGE OF THESE INSTRUCTIONS OR ON PAGE 3 OF THE BASEPLATE TOWING GENERAL INSTRUCTIONS.

20. Reinstall air dams, fascia, belly pan, grille assembly, radiator cover, pushpins, bolts and screws. *Note: Air dams may be left off vehicle or hold air dams just below original location and mark and trim the air dams to allow baseplate to fit.*

Install the tow bar and safety cables according to the instructions provided in their packages. When demonstrating this to the customer, be sure to include all the contents and packages.

Do **NOT** substitute other devices if the tow bar pins and clips are misplaced.

BX2184

2005-07 Ford Focus (Includes Foglights) Installation Instructions



Shown without removable tabs installed.



Shown without removable tabs installed.

If the baseplate is in an accident, it must be replaced. DO NOT use it again! An accident can cause unseen damage and using it again could result in more damage or serious injury. DO NOT use the baseplate if it is damaged or missing parts.

DEALER or INSTALLER:

Be certain the user receives the instruction sheets for their products.

CUSTOMER SERVICE COMMITMENT

Blue Ox is committed to providing you with exceptional customer care throughout your lifetime with our products. Our team is here to assist you with any questions you may have regarding the performance of your product. Simply call 1-800-228-9289 and you can speak with our customer care team.

Additionally, please visit our website to see which rallies our Destination America team will be attending. For a nominal fee, our service technician will service your towing system to ensure it's in proper working condition. Also as a commitment to our customers, should you visit our factory, you can stay at our full service Blue Ox campground at no charge along with enjoying a factory tour.

Again, thank you for being our customer and for the confidence you have shown in the performance of our products. It is because of customers like you we enjoy the success we have today.



© 2011 Blue Ox
One Mill Road, Industrial Park
Pender, Nebraska 68047
Phone: (402) 385-3051 • Fax: (402) 385-3360
www.blueox.com