



Baseplate Installation Instructions

BX2185

2004 Mercury Monterey Installation Instructions

Serial Number

Please read BOTH these Installation Instructions and the General Towing Instructions before attempting to install or operate this equipment.

- Blue Ox® towing products and accessories are intended to be installed by Blue Ox® Dealers who are familiar with our products and have the equipment and knowledge to do “fit work”. When necessary, Blue Ox® Dealers can be found at www.blueox.com or by contacting our Customer Care Department at (402) 385-3051.
- Many Blue Ox® Baseplates are designed to use existing holes and hardware to mount the baseplate to the towed vehicle. Even though bolts are there, do not assume they are adequate for baseplate mounting. Always use hardware supplied in the hardware kit or existing hardware specified in the Baseplate Installation Instructions.

Attachment Tab Height: 14 1/2”
Attachment Tab Width: 18”

Bolt Torque Specifications

Torque in Foot-Pounds for Metric Bolts

Bolt Size	Grade 8.8	Grade 10.9
6MM	6	8
8MM	16	22
10MM	31	40
12MM	54	70
14MM	89	117

Confirm the towability and pre-towing procedures for your vehicle with the owner’s manual or contact the vehicle’s manufacturer for specific towing procedures.

Bolt Torque Specifications

Torque in Foot-Pounds for Inch Bolts

Bolt Size	Grade 5	Grade 8
1/4”	10	14
5/16”	19	29
3/8”	33	47
7/16”	54	78
1/2”	78	119
5/8”	154	230

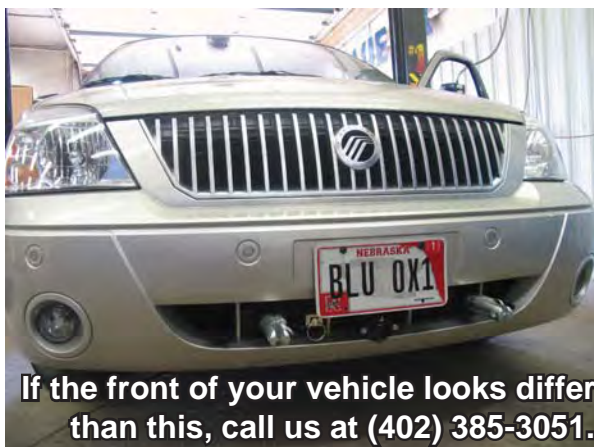

If the front of your vehicle looks different than this, call us at (402) 385-3051.

WARNING

Failure to read and follow these instructions could result in separation of the towed vehicle from the tow bar, causing property damage, loss of towed vehicle, personal injury or death.

BX2185

2004 Mercury Monterey

Installation Instructions

Parts List

Ref. No.	Qty.	Part #	Description
1	1	61-6287	Weldment, Base Plate, BX2185
2	4	61-5988	Weldment, 3/8-16 Bolt Plate, w/14" Wire
3	1	106-0369	Pipe, 3/8" Sch 40 X 1 1/2"
4	2	106-0368	Pipe, 3/8 Sch 40 X 1/2 Inch
5	6	201-0444	3/8-16 X 2 Hex Bolt, Grd. 5, ZP
6	2	203-0003	3/8" Flat Washer, ZP
7	10	203-0010	3/8" Lock Washer, ZP
8	10	202-0003	3/8-16 Hex Nut, ZP
9	1	201-0321	1/4-20 x 2 1/2" Hex Bolt, Grd. 5, ZP
10	4	203-0001	1/4" Flat Washer, ZP
11	1	203-0008	1/4" Lock Washer, ZP
12	1	202-0001	1/4-20 Hex Nut, ZP
13	2	201-0553	1/4-20 x 1/2 Hx. Wshd, Type F Screw
14	2	201-0192	#10-32 Hex Nut, ZP
15	2	203-0054	#10 Lock Washer, ZP
16	2	202-0047	#10-32 Hex Nut, ZP
17	2	101-5822	Adapter, 4 Way Connector, ZP
18	2	62-3468	Attachment, Assembly, SF/SB, (R)
	2	226-0046	Baseplate Safety Cable, 36" CL III (Not Shown)
	2	229-0359	Quicklink, 3/8, ZP (Not Shown)
	2	290-0437	Receiver, Cap Plug, Black (Not Shown)

Loctite®
 8mm So
 10mm S
 7/16" So
 9/16" So

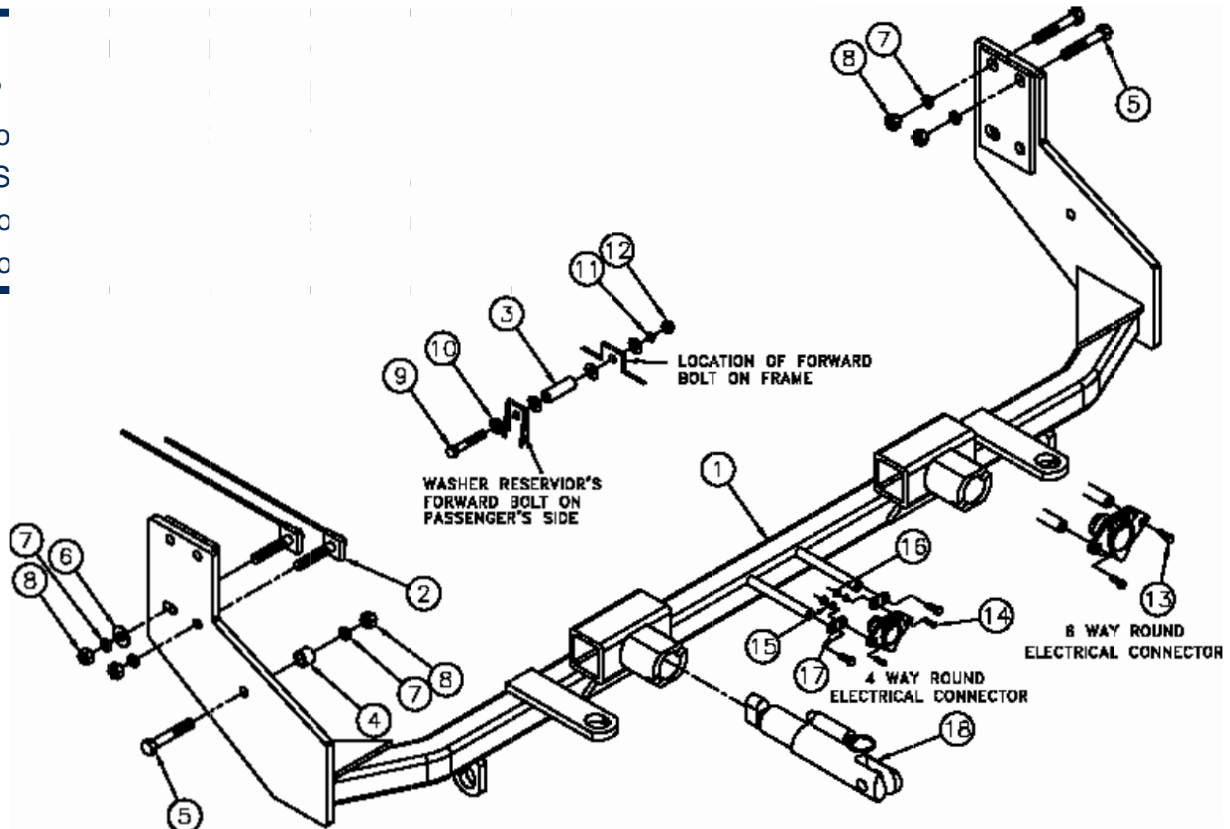

Important:

Use only genuine factory replacement parts on your baseplate. Do **NOT** substitute homemade or non-typical parts. If a bolt is lost or in need of replacement, for your safety and the preservation of your baseplate, be sure to use a replacement bolt of the same grade (In most cases it will be Grade 5, please reference the parts list above). Replacement parts may be ordered through your nearest Blue Ox® Dealer or Distributor. Failing to follow and/or altering these installation instructions in either installation or required equipment will void the manufacturer's warranty. towing behind a non-motorized vehicle will void the warranty.

BX2185

2004 Mercury Monterey

Installation Instructions

Attachment Tabs:

Motorhome mount tow bars are recommended for use with this baseplate. Due to the design of the removable tabs, the RangeFinderII and Ambassador tow bars can not be used. Adapters, except the BX8833 and BX88151, can not be used with this baseplate.

Installation Notes: The radiator cover, headlight assembly, fascia, washer reservoir and horns are removed for installation. Drilling is required.

The dimensional variations between otherwise identical vehicles can be considerable. While the baseplate was designed for easy installation, it may be necessary to tailor the baseplate slightly to compensate for auto manufacturer's tolerances. These minor adjustments may include filing a hole slightly, bending electrical rods or bending end plates.

The BX8869 Bulb and Socket Wiring Kit is recommended for this vehicle.



Installation Instructions:

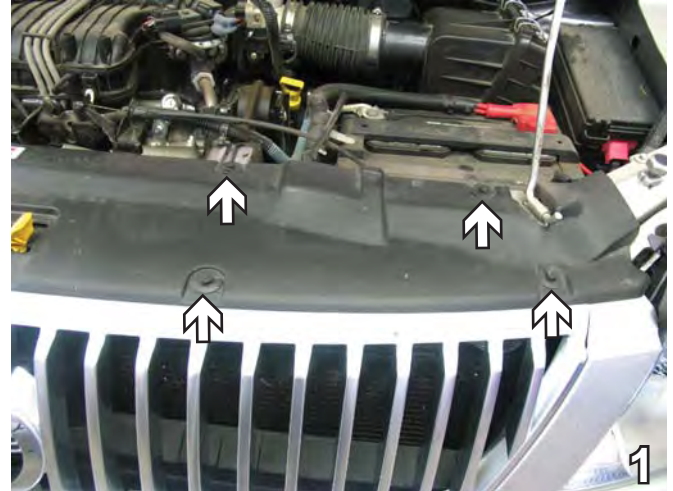

1. Remove four pushpins from the top of the radiator cover. Do this to both sides of the vehicle. Remove radiator cover. Set pushpins and radiator cover aside to be reinstalled later.



2. Remove five pushpins from the top of the grille. Set pushpins aside to be reinstalled later.

Handling of some cosmetic parts when installing this product may require the use of protective covers, rags, specialty tools, etc. to prevent damage.

BX2185
2004 Mercury Monterey
Installation Instructions



3. Pull up on two plates just behind headlight assembly to remove them. Pull headlight assembly forward, disconnect electrical and remove assembly. Do this to both sides of the vehicle. Set plates and headlight assemblies aside to be reinstalled later.



4. Using the 8mm socket, remove one metric bolt from the top corner of fascia. Do this to both sides of the vehicle. Set bolts aside to be reinstalled later.



5. Just inside wheel well, on edge of fascia, remove two Phillips screws. Do this to both sides of the vehicle. Set screws aside to be reinstalled later.



6. Push wheelwell cover aside and remove one metric bolt using the 10mm socket. Do this to both sides of the vehicle. Set bolts aside to be reinstalled later.

BX2185
2004 Mercury Monterey
Installation Instructions

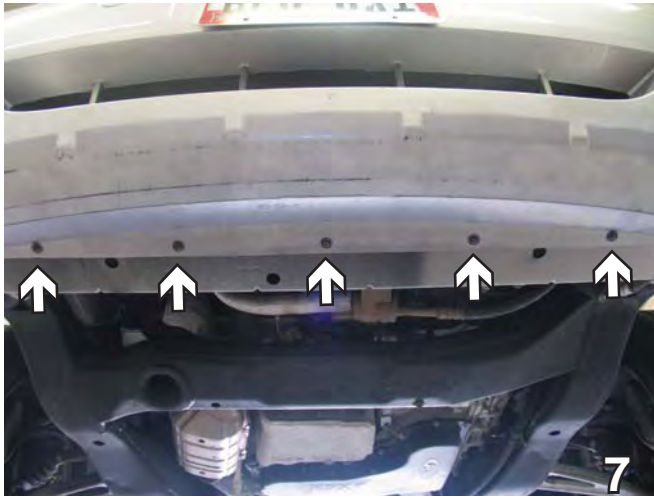

7. Remove nine Phillips screws, two each side and five in the center underneath the fascia. Pull forward on fascia to remove. Set screws and fascia aside carefully to be reinstalled later.



8. Behind the passenger's side headlight assembly, use the 8mm socket to remove one metric bolt from the inside wall of the fender well. Set bolt aside to be reinstalled later.

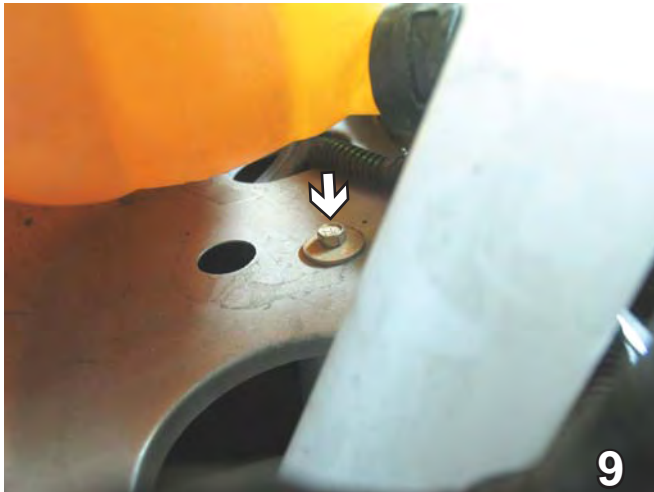

9. On the bottom of the passenger's side fenderwell, use the 8mm socket to remove one metric bolt. Set bolt aside to be reinstalled later.



10. On the passenger's side, disconnect tubes and electrical connections from the washer reservoir and plug the reservoir. Using an 8mm socket, remove the metric bolt from the reservoir bracket. Set bolt and reservoir aside to be reinstalled later.

BX2185
2004 Mercury Monterey
Installation Instructions



11. Using the reciprocating saw, cut the frame rail webbing flush with the bottom of the frame and the back of the metal bumper. Do this to both sides of the vehicle.



12. On the driver's side, disconnect electrical and use the 8mm socket to remove one metric bolt from the horn bracket. Remove horns. Set bolt and horns aside to be reinstalled later.

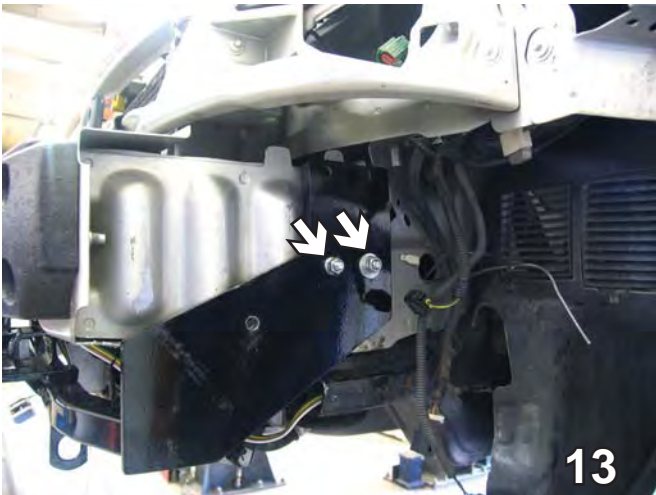

13. Align middle holes of baseplate with existing holes of frame. Insert two 3/8-16 bolt plates through the hole on side of frame rail and align with the two existing holes in the frame. Install 3/8" flat washer, 3/8" lock washer and 3/8-16 hex nut and tighten to bolt plates. Do this to both sides of the vehicle.

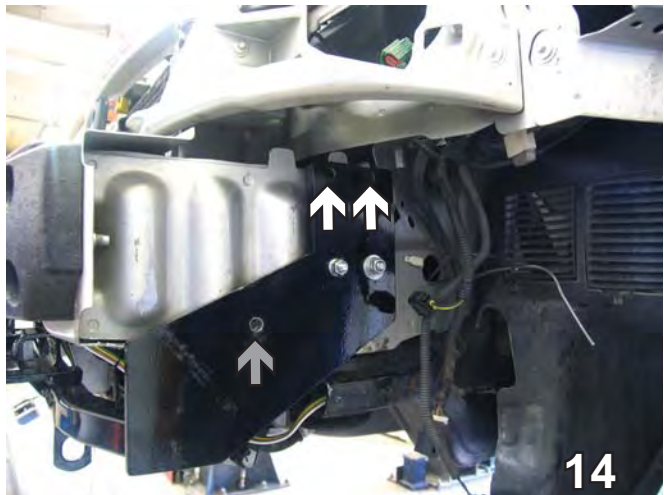

14. Using the baseplate as a template, drill three remaining holes into frame using the 13/32" drill bit. In the upper two holes (see white arrows), insert 3/8-16 x 2" hex bolts and tighten to the 3/8" lock washers and 3/8-16 hex nuts. In the lower hole (see grey arrow), insert a 3/8-16 x 2" hex bolt and tighten to the 1/2" pipe, 3/8-16 hex nut and 1/4-20 x 2 1/2" hex washer. Do this to both sides of the vehicle.

BE SURE TO USE LOCTITE® RED ON ALL BOLTS BEFORE TIGHTENING. TIGHTEN ALL BOLTS ACCORDING TO THE TORQUE CHART ON THE FRONT PAGE OF THESE INSTRUCTIONS OR ON PAGE 3 OF THE BASEPLATE TOWING GENERAL INSTRUCTIONS.

When using power drills be aware of the dangers of torque and drill bit length.

2004 Mercury Monterey

Installation Instructions



15. On passenger's side upper frame webbing, forward of the baseplate, drill out the front washer reservoir hole with the 9/32" drill bit (see white arrow). Reinstall the washer reservoir bolts. Insert the 1/4-20 x 2 1/2" hex bolt into 1/4" flat washer, forward washer reservoir hole, 1/4" flat washer, 1 1/2" pipe, 1/4" flat washer, drilled hole, 1/4" flat washer and tighten to 1/4" lock washer and hex nut.

16. Reinstall horns, headlight assemblies, fascia, radiator cover, pushpins, bolts and Phillips screws.

Be sure that **ALL** electrical connections are plugged in properly and functioning **BEFORE** installing the fascia.

BE SURE TO USE LOCTITE® RED ON ALL BOLTS BEFORE TIGHTENING. TIGHTEN ALL BOLTS ACCORDING TO THE TORQUE CHART ON THE FRONT PAGE OF THESE INSTRUCTIONS OR ON PAGE 3 OF THE BASEPLATE TOWING GENERAL INSTRUCTIONS.

Install the tow bar and safety cables according to the instructions provided in their packages. When demonstrating this to the customer, be sure to include all the contents and packages.

Do **NOT** substitute other devices if the tow bar pins and clips are misplaced.



17. Attach the permanent baseplate safety cables to the provided convenience link on the baseplate (see grey arrow). The photo above shows the recommended installation of the cables to frame of vehicle (see white arrow). Additional options may interfere with suggested mounting; in this case secure the cables to a solid piece of the frame as described in the instructions included with the permanent baseplate safety cables. Be sure the safety cables do not rub against any hoses or moving parts. Do this to both sides of the vehicle.

BX2185

2004 Mercury Monterey

Installation Instructions

DEALER or INSTALLER:

Be certain the user receives the instruction sheets for their products.

CUSTOMER SERVICE COMMITMENT

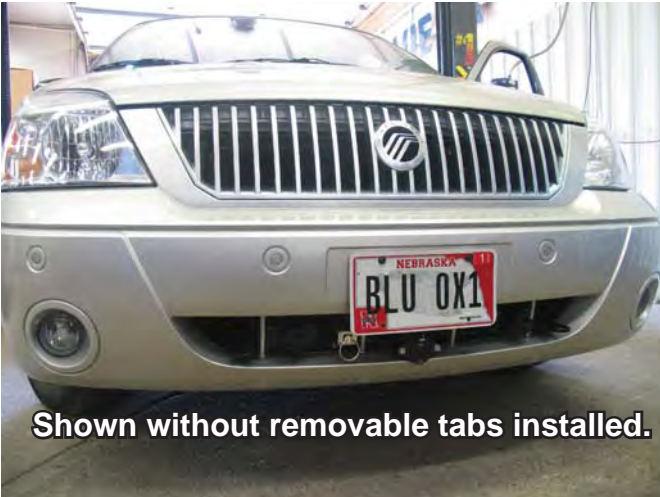

Shown without removable tabs installed.

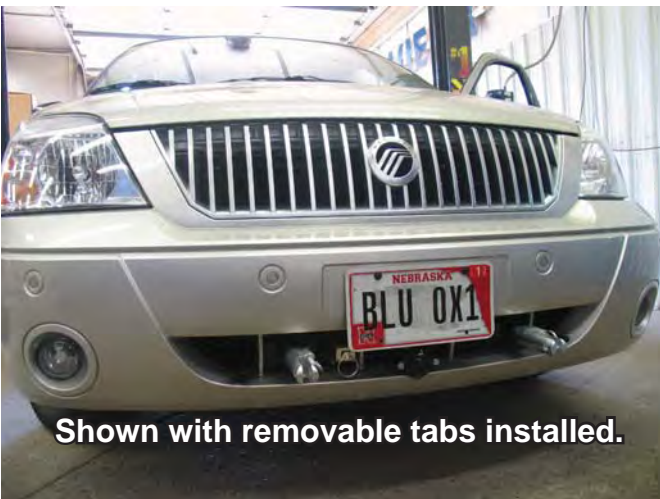

Shown with removable tabs installed.

Blue Ox is committed to providing you with exceptional customer care throughout your lifetime with our products. Our team is here to assist you with any questions you may have regarding the performance of your product. Simply call 1-402-385-3051 and you can speak with our customer care team.

Additionally, please visit our website to see which rallies our Destination America team will be attending. For a nominal fee, our service technician will service your towing system to ensure it's in proper working condition. Also as a commitment to our customers, should you visit our factory you can stay at our full service Blue Ox campground at no charge along with enjoying a factory tour.

Again thank you for being our customer and for the confidence you have shown in the performance of our products. It is because of customers like you we enjoy the success we have today.



© 2006, 08, 10 Blue Ox
One Mill Road, Industrial Park
Pender, Nebraska 68047
Phone: (402) 385-3051 • Fax: (402) 385-3360
www.blueox.com