



BX2195

2007-11 Ford Ranger XLT 4WD 2011 Ford Ranger Edge 2WD Installation Instructions

Serial Number

Please read BOTH these Installation Instructions and the General Towing Instructions before attempting to install or operate this equipment.

- Blue Ox® towing products and accessories are intended to be installed by Blue Ox® Dealers who are familiar with our products and have the equipment and knowledge to do “fit work.” When necessary, Blue Ox® Dealers can be found at www.blueox.com or by contacting our Customer Care Department at (402) 385-3051.
- Many Blue Ox® Baseplates are designed to use existing holes and hardware to mount the baseplate to the towed vehicle. Even though bolts are there, do not assume they are adequate for baseplate mounting. Always use hardware supplied in the hardware kit or existing hardware specified in the Baseplate Towing Installation Instructions.

Attachment Tab Height: 21”
Attachment Tab Width: 17”

Bolt Torque Specifications

Torque in Foot-Pounds for Metric Bolts

Bolt Size	Grade 8.8	Grade 10.9
6MM	6	8
8MM	16	22
10MM	31	40
12MM	54	70
14MM	89	117

Confirm the towability and pre-towing procedures for your vehicle with the owner’s manual or contact the vehicle’s manufacturer for specific towing procedures.

Bolt Torque Specifications

Torque in Foot-Pounds for Inch Bolts

Bolt Size	Grade 5	Grade 8
1/4”	10	14
5/16”	19	29
3/8”	33	47
7/16”	54	78
1/2”	78	119
5/8”	154	230

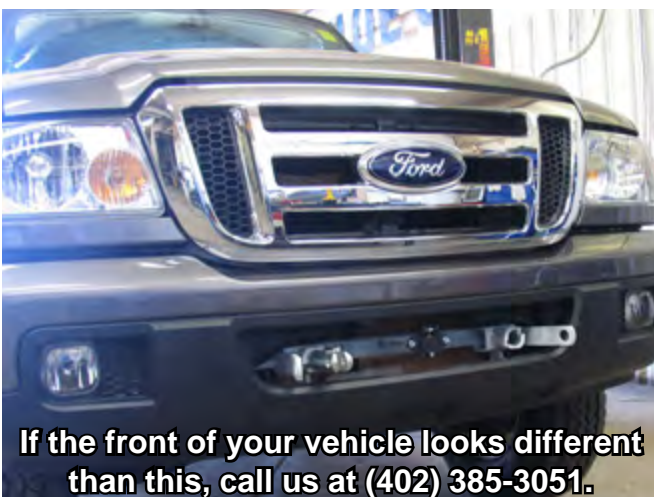

If the front of your vehicle looks different than this, call us at (402) 385-3051.

WARNING

Failure to read and follow these instructions could result in separation of the towed vehicle from the tow bar, causing property damage, loss of towed vehicle, personal injury or death.



BX2195

2007-11 Ford Ranger XLT 4WD 2011 Ford Ranger Edge 2WD Installation Instructions

Parts List

Ref. No.	Qty.	Part #	Description
1	1	61-6406	Weldment, Baseplate, BX2195
2	8	61-3799	Weldment, 1/2-13 Nut Plate with 10" wire
3	8	201-0051	1/2-13 X 1 1/2 Hex Bolt Grd.5, ZP
4	8	203-0012	1/2 Lock Washer, ZP
5	2	201-0553	1/4-20 X 1/2 Hex Wshd., Type F Screw
6	2	201-0192	#10-32 X 1/2 Slot, Rd. Hd. Screw
7	2	203-0054	#10 Lock Washer
8	2	202-0047	#10-32 Hex Nut
9	2	101-5822	Adapter, 4 Way Connector
10	2	62-3468	Attachment Tab Assembly (Rem), SF/SB, 1 Hole
	2	290-0437	Cap Plug, Black (Not Shown)
	2	229-0359	Quicklink, 3/8", ZP (Not Shown)
	2	226-0046	Baseplate Safety Cable, 36" Class III (Not Shown)

Tools Required

- | | |
|------------------|-------------|
| Loctite® RED | Vise Grips |
| 13MM Socket | 15MM Socket |
| 18MM Socket | 3/4" Socket |
| Flat Screwdriver | 3/8" Socket |
| Hammer | Drill |
| 17/32" Drill Bit | |

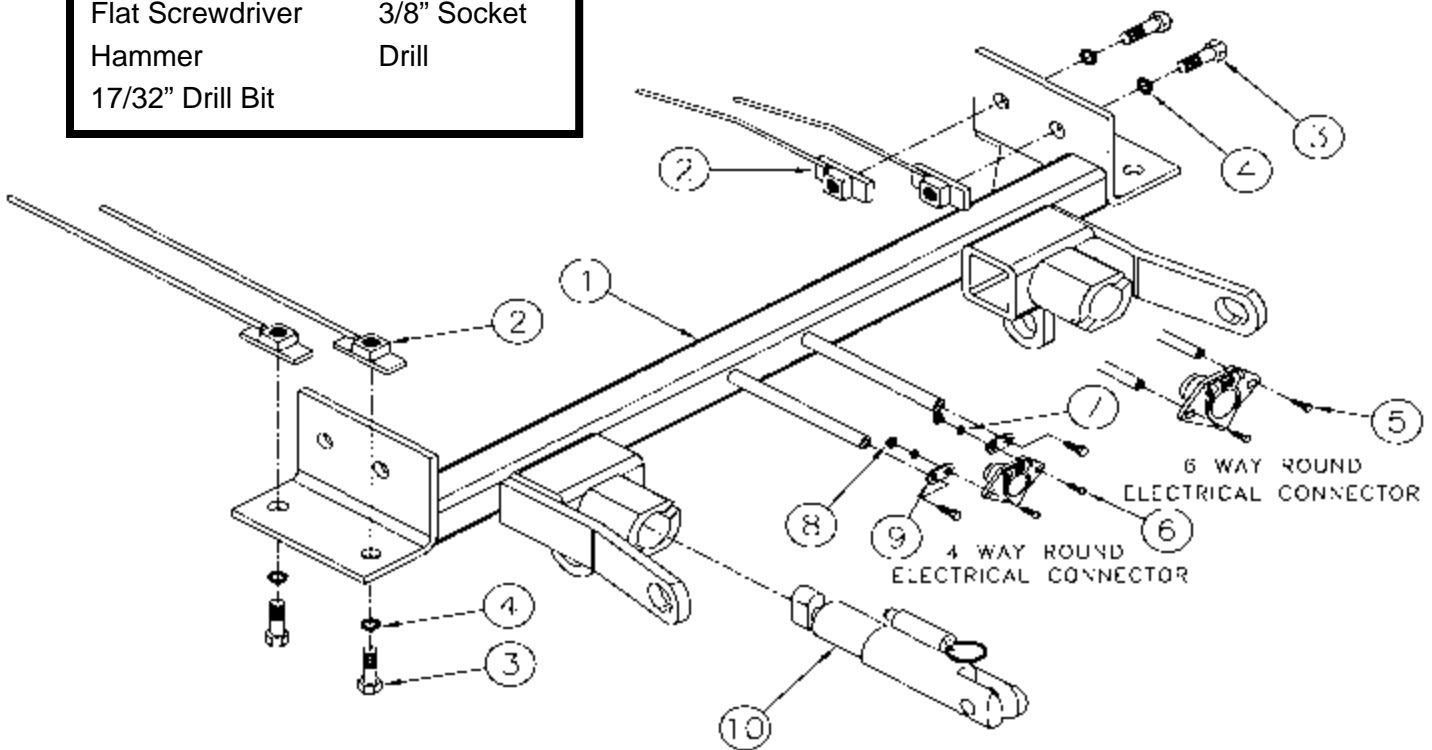

Important:

Use only genuine factory replacement parts on your baseplate. Do **NOT** substitute homemade or non-typical parts. If a bolt is lost or in need of replacement, for your safety and the preservation of your baseplate, be sure to use a replacement bolt of the same grade (In most cases it will be Grade 5, please reference the parts list above). Replacement parts may be ordered through your nearest Blue Ox® Dealer or Distributor. Failing to follow and/or altering these installation instructions in either installation or required equipment will void the manufacturer's warranty. Towing behind a non-motorized vehicle will void the warranty.



BX2195

2007-11 Ford Ranger XLT 4WD 2011 Ford Ranger Edge 2WD Installation Instructions

Vehicle Weight: Motorhome mount tow bars are recommended for use with this baseplate. Due to the design of the removable tabs, the RangeFinderII, Adventurer, Acclaim and Ambassador tow bars can not be used. The Acclaim tow bar may be used, but will not fold and store on the front of the vehicle. Adapters, except the BX8833 and BX88151, can not be used with this baseplate.

Installation Notes: The fascia and air dam are removed for installation. Remove tow hooks (will not be reinstalled).

The dimensional variations between otherwise identical vehicles can be considerable. While the baseplate was designed for easy installation, it may be necessary to tailor the baseplate slightly to compensate for auto manufacturer's tolerances. These minor adjustments may include filing a hole slightly, bending electrical rods or bending end plates.

The BX8869 Bulb and Socket Wiring Kit is recommended for this vehicle.



Possible Location for the BX8869 Bulb and Socket Wiring Kit.

Installation Instructions

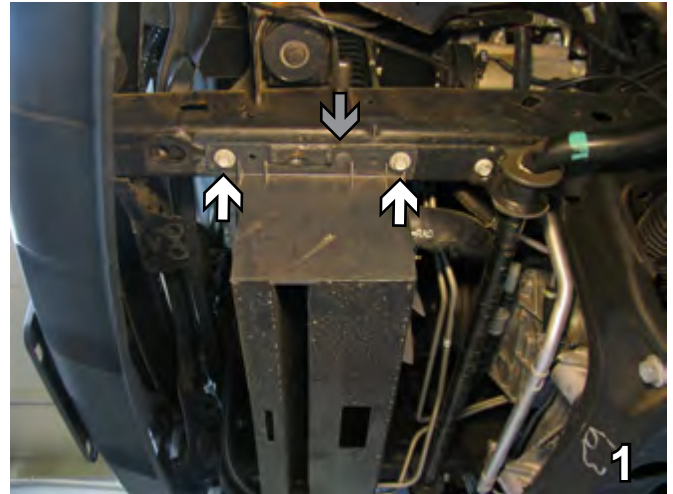

1. Remove belly pan from under the vehicle. Using a 13MM socket, remove two bolts and also one push pin (gray arrow) with a flat screwdriver. Do this to both sides. Set aside for later reinstallation.

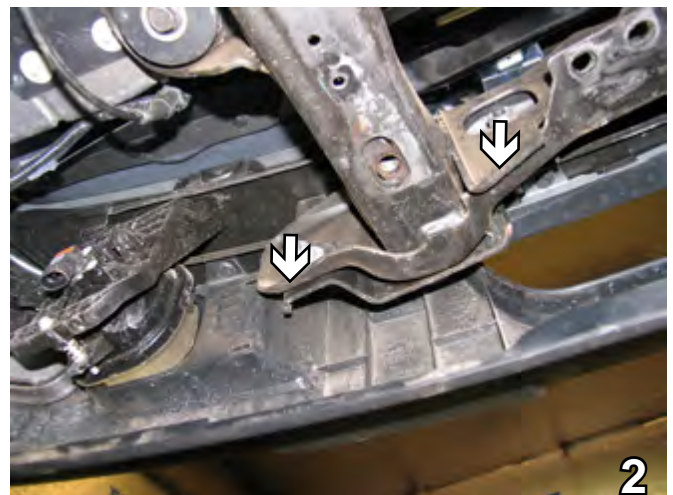

2. To remove front bumper, go underneath vehicle on backside of bumper to remove two hex nuts with a 18MM socket. Do this to both sides. Place hex nuts and bumper aside for later reinstallation. Unplug the foglights if available.



BX2195

2007-11 Ford Ranger XLT 4WD 2011 Ford Ranger Edge 2WD Installation Instructions



3. Place a piece of cardboard over radiator to keep from bending fins. While using a 15MM socket, remove three bolts behind tow hooks (inset circle). Remove tow hooks. Do to both sides. Tow hooks will not be reinstalled.

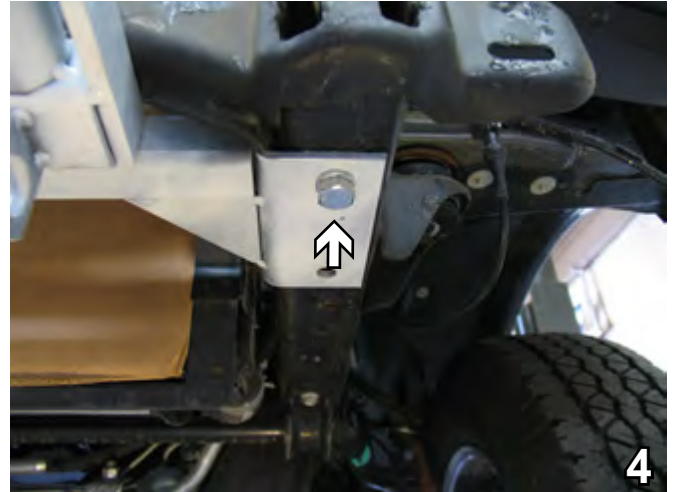

4. Install the baseplate by first installing 1/2 x 1 1/2" lock washer with nut plate in first hole that lines up with existing hole. If hole in frame end is not quite big enough to install nut plate, use hammer to widen opening. Do this to both sides.

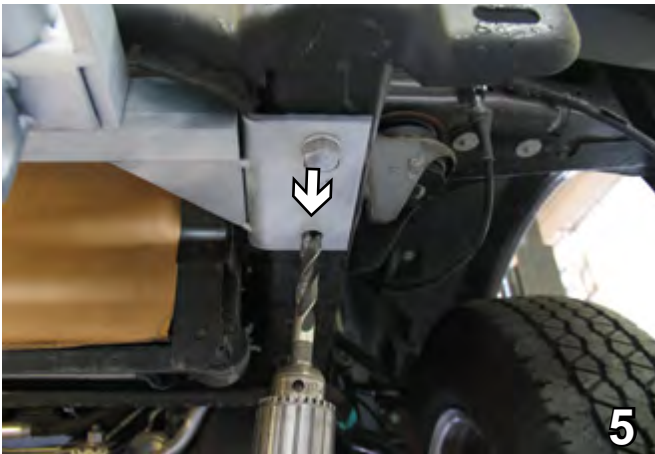

5. Using a 17/32" drill bit, drill the last hole on the end of the baseplate. Put nut plate in end of frame rail to align with drilled holes. Install nut plates and lock washers. Do this to both sides.

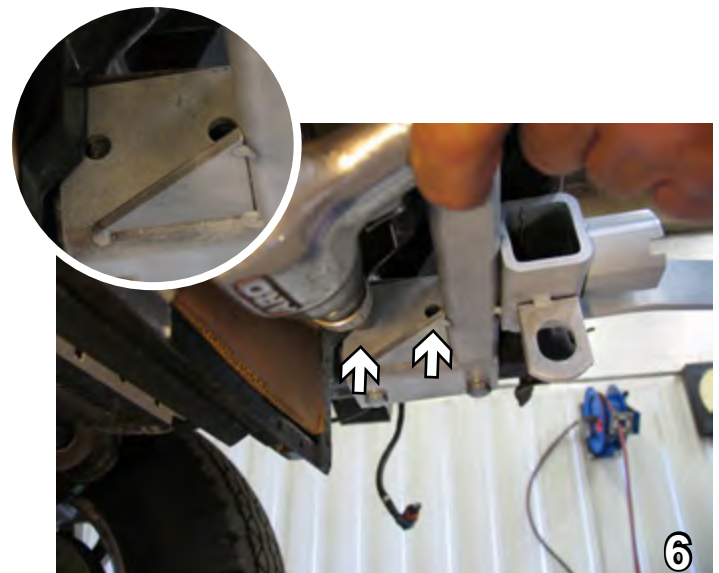

6. While using the baseplate as a template, drill the two holes located inside of the baseplate closest to the radiator. Drill with a 17/32" drill bit. Do this to both sides. Install a 1/2 x 1 1/2" hex bolt and 1/2" lock washer to each of the drilled holes into nut plate.

When using power drills be aware of the dangers of torque and drill bit length.

BE SURE TO USE LOCTITE® RED ON ALL BOLTS BEFORE TIGHTENING. TIGHTEN ALL BOLTS ACCORDING TO THE TORQUE CHART ON THE FRONT PAGE OF THESE INSTRUCTIONS OR ON PAGE 3 OF THE BASEPLATE TOWING GENERAL INSTRUCTIONS.



BX2195

2007-11 Ford Ranger XLT 4WD 2011 Ford Ranger Edge 2WD Installation Instructions

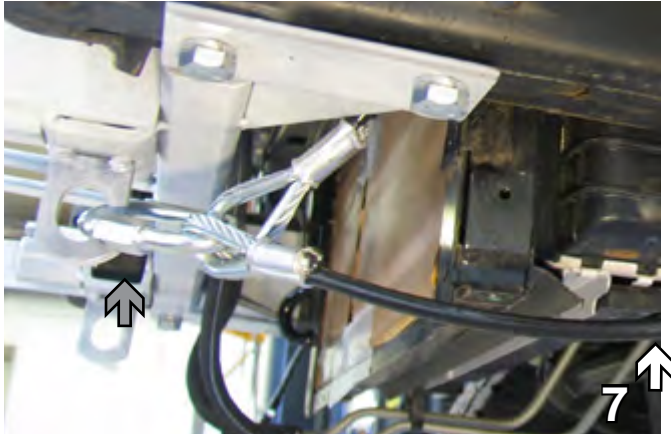

7. Attach the permanent baseplate safety cables to the provided convenience link on the baseplate (gray arrow). The photo above shows the recommended installation of the cables to frame of vehicle (white arrow). Additional options may interfere with suggested mounting; in this case secure the cables to a solid piece of the frame as described in the instructions included with the permanent baseplate safety cables. Be sure the safety cables do not rub against any hoses or moving parts. Do this to both sides of the vehicle.

8. Remove cardboard used to protect radiator, reinstall belly pan, bumper, bolts and pushpin. The installation of the baseplate is complete.

Be sure that **ALL** electrical connections are plugged in properly and functioning **BEFORE** installing the fascia.

Install the tow bar and safety cables according to the instructions provided in their packages. When demonstrating this to the customer, be sure to include all the contents and packages.

Do **NOT** substitute other devices if the tow bar pins and clips are misplaced.

DEALER or INSTALLER:
Be certain the user receives the instruction sheets for their products.



BX2195

2007-11 Ford Ranger XLT 4WD 2011 Ford Ranger Edge 2WD Installation Instructions



With removable tabs



Without removable tabs

If the baseplate is in an accident, it must be replaced. DO NOT use it again! An accident can cause unseen damage and using it again could result in more damage or serious injury. DO NOT use the baseplate if it is damaged or missing parts.

CUSTOMER SERVICE COMMITMENT

Blue Ox is committed to providing you with exceptional customer care throughout your lifetime with our products. Our team is here to assist you with any questions you may have regarding the performance of your product. Simply call (402) 385-3051 and you can speak with our customer care team.

Additionally, please visit our website to see which rallies our Destination America team will be attending. For a nominal fee, our service technician will service your towing system to ensure it's in proper working condition. Also as a commitment to our customers, should you visit our factory, you can stay at our full service Blue Ox campground at no charge along with enjoying a factory tour.

Again, thank you for being our customer and for the confidence you have shown in the performance of our products. It is because of customers like you we enjoy the success we have today.



© 2011 Blue Ox
One Mill Road, Industrial Park
Pender, Nebraska 68047

Phone: (402) 385-3051 • Fax: (402) 385-3360
www.blueox.com