



**BLUE OX**

Baseplate Installation Instructions

BX2237

# 2005-07 Honda Odyssey Installation Instructions

Serial Number

Please read BOTH these Installation Instructions and the General Instructions before attempting to install or operate this equipment.

- Blue Ox® towing products and accessories are intended to be installed by Blue Ox® Dealers who are familiar with our products and have the equipment necessary and knowledge to do "fit work". When necessary Blue Ox® Dealers can be found at [www.blueox.com](http://www.blueox.com) or by contacting our Customer Care Department at (402) 385-3051.
- Many Blue Ox® Baseplates are designed to use existing holes and hardware to mount the baseplate to the towed vehicle. Even though bolts are there, do not assume they are adequate for baseplate mounting. Always use hardware supplied in the hardware kit and existing hardware specified in the Baseplate Installation Instructions.

Attachment Tab Height: 21"

Attachment Tab Width: 18"

### Bolt Torque Specifications

Torque in Foot-Pounds for Metric Bolts

Bolt Size	Grade 8.8	Grade 10.9
6MM	6	8
8MM	16	22
10MM	31	40
12MM	54	70
14MM	89	117

Confirm the towability and pre-towing procedures for your vehicle with the owner's manual or contact the vehicle's manufacturer for specific towing procedures.

### Bolt Torque Specifications

Torque in Foot-Pounds for Inch Bolts

Bolt Size	Grade 5	Grade 8
1/4"	10	14
5/16"	19	29
3/8"	33	47
7/16"	54	78
1/2"	78	119
5/8"	154	230



If the front of your vehicle looks different than this, call us at (402) 385-3051.

## WARNING

Failure to read and follow these instructions could result in separation of the towed vehicle from the tow bar, causing property damage, loss of towed vehicle, personal injury or death.

# BX2237

## 2005-07 Honda Odyssey

### Installation Instructions

#### Parts List

Ref. No.	Qty.	Part #	Description
1	1	61-6079	Weldment, Baseplate, BX2237
2	6	61-5208	3/8" Nutplate, with 14" Wire
3	4	201-0443	3/8-16 x 1" Hex Bolt, Grd. 5, ZP
4	6	201-0440	3/8-16 x 1 1/2" Hex Bolt, Grd. 5, ZP
5	10	203-0010	3/8" Lock Washer, ZP
6	4	202-0003	3/8-16 Hex Nut, ZP
7	4	201-0446	8MM-1.25 x 30MM Hex Bolt, Grd. 8.8, ZP
8	4	203-0102	8MM Lock Washer, ZP
9	4	203-0003	3/8" Flat Washer, ZP
10	2	201-0553	1/4-20 x 1/2" Hx. Wshd, Type F Screw
11	2	201-0192	#10-32 x 1/2" Slot, Rd. Hd. Screw
12	2	203-0054	#10 Lock Washer
13	2	202-0047	#10-32 Hex Nut, ZP
14	2	101-5822	Adapter, 4 Way Connector
15	2	62-3468	Attachment, Assembly, SF/SB (R)
	2	226-0046	Baseplate Safety Cable, 36" CL III (Not Shown)
	2	229-0359	Quicklink, 3/8, ZP (Not Shown)
	2	290-0437	Cap Plug, Black (Not Shown)

#### Tools Required

8MM Socket	12MM Socket
10MM Socket	13MM Socket
17MM Socket	9/16" Socket
Phillips Screwdriver	13/32" Drill Bit
Vise Grips	Reciprocating Saw
Utility Knife	LOCTITE Red

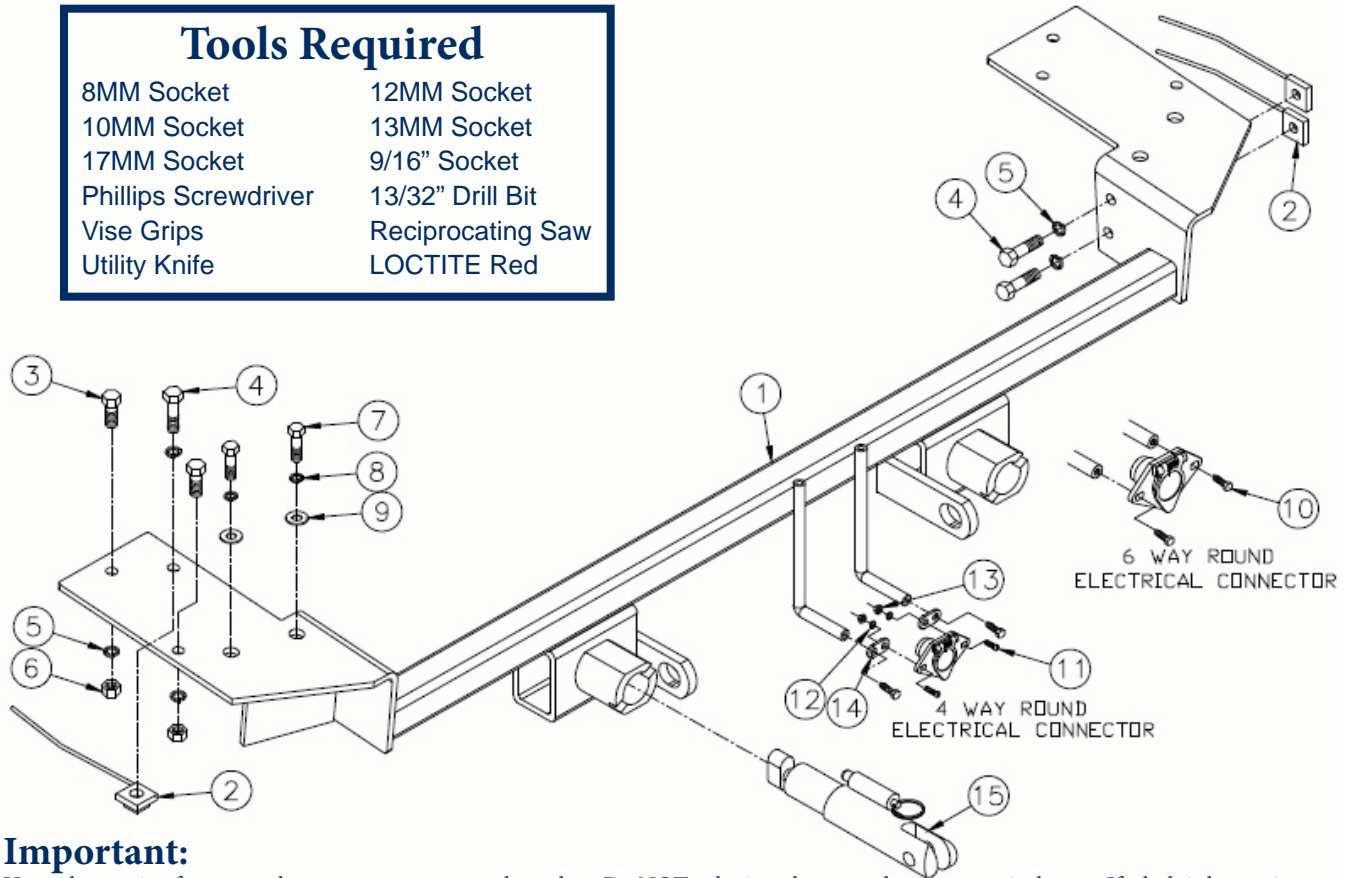

#### Important:

Use only genuine factory replacement parts on your baseplate. Do NOT substitute homemade or non-typical parts. If a bolt is lost or in need of replacement, for your safety and the preservation of your baseplate, be sure to use a replacement bolt of the same grade (In most cases it will be Grade 5, please reference the parts list above). Replacement parts may be ordered through your nearest Blue Ox® Dealer or Distributor, or call our Customer Care Team at (402)385-3051. Failing to follow and/or altering these installation instructions in either installation or required equipment will void the manufacturer's warranty. Towing behind a non-motorized vehicle will void the warranty.

BX2237

# 2005-07 Honda Odyssey Installation Instructions

## Removable Tabs:

Motorhome mount tow bars are recommended for use with this baseplate. Due to the design of the removable tabs, the RangeFinder II, adventurer, and Ambassador tow bars can not be used. The Acclaim tow bar may be used, but will not fold and store on the front of the vehicle. Adapters, except the BX8833 and BX88151, can not be used with this baseplate.

## Instructions:

The plastic cover, front fascia, headlight assembly, and the metal bumper are removed and reinstalled for the baseplate installation. Drilling and trimming are required. The metal bumper will not be reinstalled.

The dimensional variations between otherwise identical vehicles can be considerable. While the baseplate was designed for easy installation, it may be necessary to tailor the baseplate slightly to compensate for auto manufacturer's tolerances. These minor adjustments may include filing a hole slightly, bending electrical rods or bending end plates.

The BX8869 Bulb and Socket Wiring Kit is available for this vehicle.



## Installation Instructions

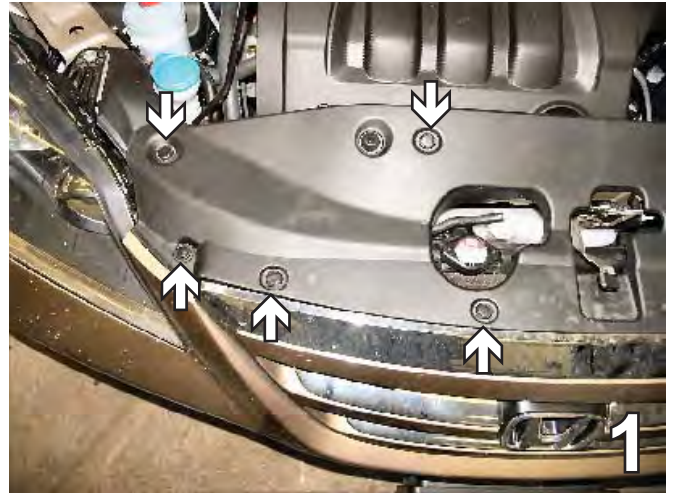

1. Remove the five push pins from the black plastic cover on the top side of the fascia. Do this to both sides of the vehicle. Lift cover up to remove. Set cover and pushpins aside to be reinstalled later.



2. Remove one pushpin from the top edge of the fascia just inside of the headlight assembly. Do this to both sides of the vehicle.

Handling of some cosmetic parts when installing this product may require the use of protective covers, rags, specialty tools, etc. to prevent damage.

BX2237  
2005-07 Honda Odyssey  
Installation Instructions



3. Using a 10MM socket remove one metric bolt from just forward of the front tire. Do this to both sides of the vehicle.



4. Using the Phillips screwdriver, remove the Phillips screw from the corner of the fascia just forward of the front tire, inside the wheel well cover. Do this to both sides of the vehicle.



5. Remove the six pushpins from the lower edge of the fascia and the belly pan. Pull the fascia forward to remove. Set the pushpins and fascia aside carefully to be reinstalled later.



6. Remove one metric bolt, as indicated by the white arrow in the photo above, with the 10MM socket and one pushpin, as indicated by the grey arrow in the photo above, from the top side of the headlight assembly. Do this to both sides of the vehicle. Set the bolts and pushpins aside to be reinstalled later.

BX2237  
2005-07 Honda Odyssey  
Installation Instructions



7. Using the 10MM socket, remove one metric bolt from the side of the headlight assembly. Do this to both sides of the vehicle. Set the bolts aside to be reinstalled later.



8. Using a 10MM socket, remove two metric bolts from the headlight assembly. Unplug and set the headlight assembly and metric bolts aside to be reinstalled later. Do this to both sides of the vehicle.

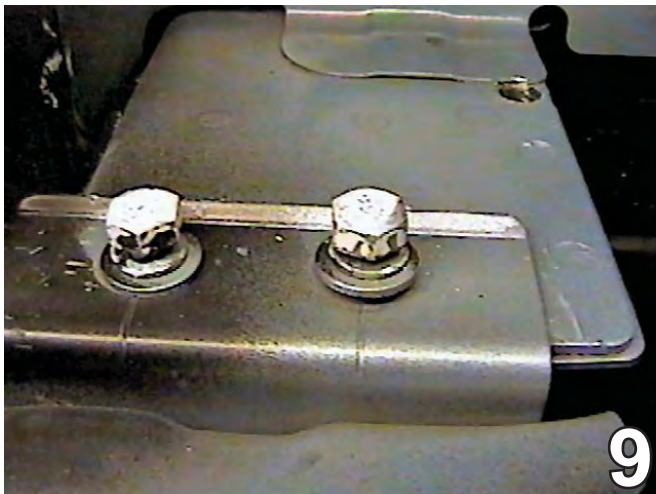

9. Using the 12MM socket, remove two metric bolts from the top of the metal bumper. Do this to both sides of the vehicle. Set the bolts aside to be reinstalled later.



10. Remove the metric bolt from the bottom of the metal bumper with the 12MM socket. Pull the metal bumper forward to remove. The metal bumper will not be reinstalled.

When using power drills be aware of the dangers of torque and drill bit length.

BX2237  
2005-07 Honda Odyssey  
Installation Instructions

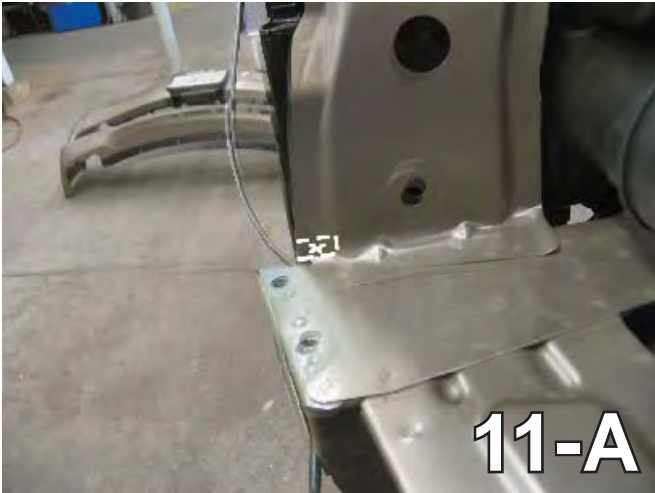

11. Cut the front webbing on the top edge of the frame and the 1/2" above the frame with the reciprocating saw. Bend the webbing toward the headlight area. Do this to both sides of the vehicle. This will open the area for the baseplate installation.

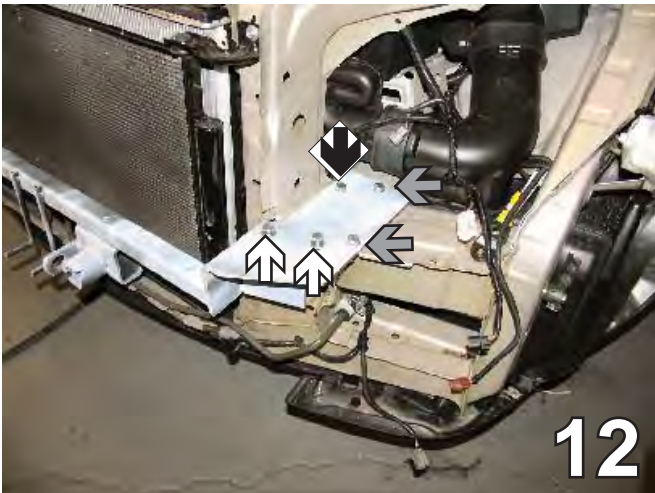

**BE SURE TO USE LOCTITE® RED ON ALL BOLTS BEFORE TIGHTENING. TIGHTEN ALL BOLTS ACCORDING TO THE TORQUE CHART ON THE FRONT PAGE OF THESE INSTRUCTIONS OR ON PAGE 3 OF THE BASEPLATE TOWING GENERAL INSTRUCTIONS.**

12. Slide the baseplate on the top of the frame and align the two front holes of the baseplate with the existing holes in the frame for the bumper. Tighten the 8MM hex bolt, 8MM lock washer, and 3/8" flat washer into the existing holes for the metal bumper, using the 13MM socket. (**LOCTITE**) Using the baseplate as a template, drill the holes in the top of the baseplate into the frame with the 13/32" drill bit. Insert the 3/8" x 1" hex bolts into the outside two drilled holes in the top of the frame webbing, tighten the 3/8" lock washers and the hex nuts on the back side of the frame webbing. Insert 3/8" x 1 1/2" bolt and 3/8" lock washer with 3/8" nut plate.

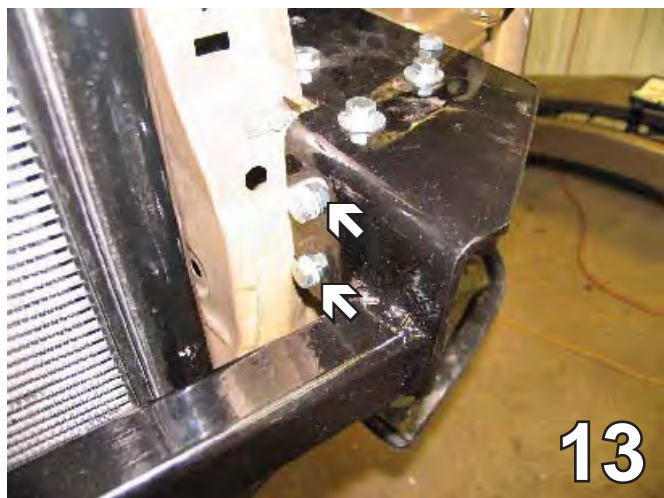

13. Using the baseplate as a template, drill the two holes in the side of the baseplate into the frame with the 13/32" drill bit. Do this to both sides of the vehicle. Insert the nutplate into the end of the frame to align with the drilled holes, tighten the 3/8" x 1 1/2" hex bolt and lock washer with the 9/16" socket. Do this to both sides of the vehicle. (**LOCTITE**)

# BX2237

## 2005-07 Honda Odyssey

### Installation Instructions

14. Reinstall headlight assemblies, the fascia, bolts and push pins.

Be sure that **ALL** electrical connections are plugged in properly and functioning **BEFORE** Installing the fascia.

**DEALER or INSTALLER:**  
Be certain the user receives the instruction sheets for their products.

Install the tow bar and safety cables according to the instructions included in their packages.

Do not substitute other devices if the tow bar pin and clip are lost.

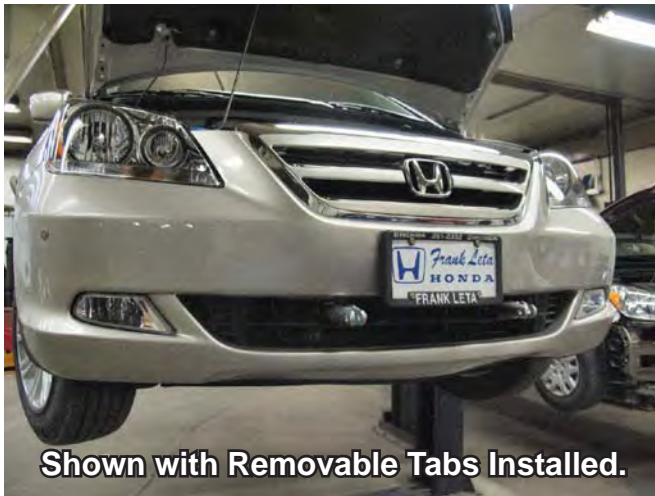

**Shown with Removable Tabs Installed.**

If the baseplate is in an accident, it must be replaced. **DO NOT** use it again! An accident can cause unseen damage and using it again could result in more damage or serious injury. **DO NOT** use the baseplate if it is damaged or missing parts.

#### CUSTOMER SERVICE COMMITMENT

Blue Ox is committed to providing you with exceptional customer care throughout your lifetime with our products. Our team is here to assist you with any questions you may have regarding the performance of your product. Simply call 1-(402) 385-3051 and you can speak with our customer care team.

Additionally, please visit our website to see which rallies our Destination America team will be attending. For a nominal fee, our service technician will service your towing system to ensure it's in proper working condition. Also as a commitment to our customers, should you visit our factory you can stay at our full service Blue Ox campground at no charge along with enjoying a factory tour.

Again thank you for being our customer and for the confidence you have shown in the performance of our products. It is because of customers like you we enjoy the success we have today.



© 2004, 06, 08, 09, 10 Blue Ox  
One Mill Road, Industrial Park  
Pender, Nebraska 68047  
Phone: (402) 385-3051  
Toll Free: (888) 425-5382  
Fax: (402) 385-3360  
[www.blueox.com](http://www.blueox.com)  
10/19/10