



BX2258

2012-13 Honda CR-V Installation Instructions

Serial Number

Attachment Tab Height: 15.5"

Attachment Tab Width: 24"

Please read BOTH these Installation Instructions and the General Instructions prior to installing or operating this equipment.

- Blue Ox® towing products and accessories are intended to be installed by Blue Ox® Dealers who are familiar with our products and have the equipment and knowledge necessary to do "fit work". If needed, Blue Ox® Dealers can be found at www.blueox.com or by contacting our Customer Care Department at (402) 385-3051.
- Many Blue Ox® baseplates are designed to use existing holes and hardware to mount the baseplate to the towed vehicle. Even though bolts are there, do not assume they are adequate for baseplate mounting. Always use the hardware supplied in the hardware kit and existing hardware as specified in the installation instructions.

Bolt Torque Specifications
Torque in Foot-Pounds for Metric Bolts

Bolt Size	Grade 8.8	Grade 10.9
6MM	6	8
8MM	16	22
10MM	31	40
12MM	54	70
14MM	89	117



If the front of your vehicle looks different than this, please contact us at (402)385-3051.

Reference your vehicle owner's manual for manufacturer's towing specifications.

Bolt Torque Specifications
Torque in Foot-Pounds for Inch Bolts

Bolt Size	Grade 5	Grade 8
1/4"	10	14
5/16"	19	29
3/8"	33	47
7/16"	54	78
1/2"	78	119
5/8"	154	230

WARNING

Failure to read and follow these instructions could result in separation of the towed vehicle from the tow bar, causing property damage, loss of towed vehicle, personal injury or death.



BX2258

2012-13 Honda CR-V Installation Instructions

Removable Tabs: Due to the design of the removable tabs, the RangeFinderII tow bar can not be used. Adapters, except the BX8833 and BX88151, can not be used with this baseplate.

Instruction Notes: The fascia, coolant line and temperature sensor are removed and reinstalled for the baseplate installation. Some drilling and trimming is required.

The dimensional variations between otherwise identical vehicles can be considerable. While the baseplate was designed for easy installation, it may be necessary to tailor the baseplate slightly to compensate for vehicle manufacturer's tolerances. These minor adjustments may include filing a hole slightly, bending electrical rods or bending end plates.

The BX8869 Tail Light Wiring Kit is recommended for this vehicle.



NOTICE

- Handling of some cosmetic parts when installing this product may require the use of protective covers, rags, specialty tools, etc. to prevent damage.
- When using power drills be aware of the dangers of torque and drill bit length.
- Be sure that **ALL** electrical connections are plugged in properly and functioning before reinstalling the fascia.
- Do not use the towed vehicle for storing luggage, equipment, etc. This may cause you to exceed the towing capacity of the tow bar, baseplate and its accessories.
- Be sure to use Loctite® Red on all bolts before tightening. Tighten all bolts according to the torque chart provided.



BX2258

2012-13 Honda CR-V Installation Instructions

Tools Required

Large Vise Grip
Utility Knife
Drill
12MM Socket

Flat Screwdriver
Torque Wrench
Loctite® RED
13MM Socket

Phillips Screwdriver
Tape Measure
10MM Socket
3/4" Socket

Item No.	Part No.	Description	Qty.
1.....	61-4604.....	1/2"-13 Nut Plate with 10" Wire.....	4
2.....	61-7002.....	BX2258 Baseplate.....	1
3.....	62-3468.....	Attachment Tab Assembly with Hole.....	2
4.....	101-5822.....	4 Way Connector Adapter.....	2
5.....	102-7195.....	Breakaway Bracket.....	1
6.....	201-0050.....	1/4"-20 x 3/4" Hex Head Bolt, Grade 5, ZP.....	2
7.....	201-0051.....	1/2"-13 x 1-1/2" Hex Head Bolt, Grade 5, ZP.....	4
8.....	201-0192.....	#10-32 1/2" Round Slotted Head Screw.....	2
9.....	201-0446.....	8MM-1.25 x 30MM Hex Bolt, Grade 8.8, ZP.....	6
10.....	201-0553.....	1/4"-20 x 1/2" Self Tapping Screw, ZP.....	2
11.....	202-0047.....	#10-32 Hex Nut.....	2
12.....	202-0102.....	1/4"-20 Hex Nylon Nut, ZP.....	2
13.....	203-0012.....	1/2" Lock Washer, ZP.....	4
14.....	203-0054.....	#10 Lock Washer.....	2
15.....	203-0102.....	8MM Lock Washer, ZP.....	6
16.....	203-0002.....	5/16" Flat Washer, ZP.....	6
17 (not shown).....	226-0046.....	36" Class III Baseplate Safety Cable.....	2
18 (not shown).....	229-0359.....	3/8" Quicklink, ZP.....	2
19 (not shown).....	290-0159.....	13" Nylon Cable Tie.....	1
20 (not shown).....	290-0437.....	Black Cap Plug Receiver.....	2
21 (not provided).....	293-1336.....	Breakaway Switch.....	1
22 (not provided).....	294-0805.....	4 Pin Connector.....	1
23 (not provided).....	294-0902.....	6 Pin Connector.....	1

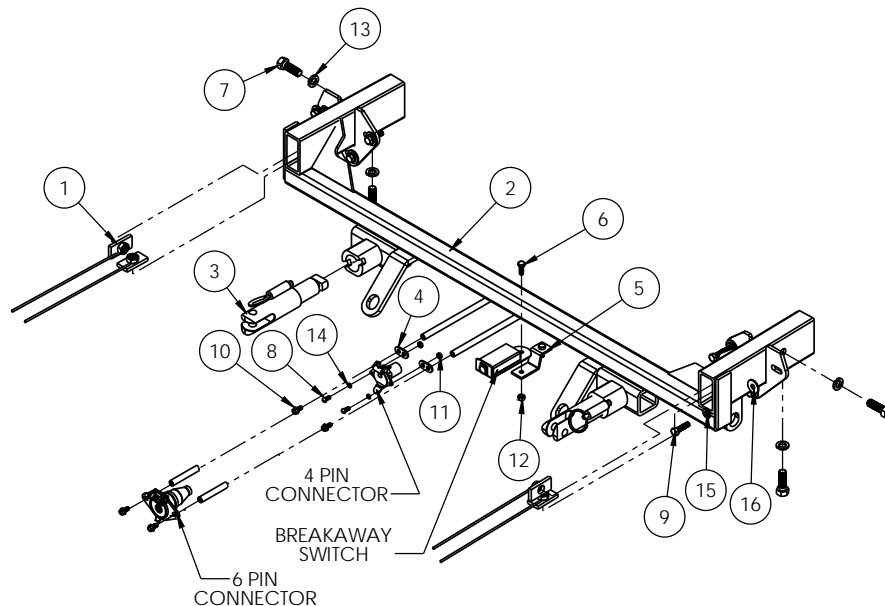



1. Using a Phillips screwdriver remove the screw at the bottom of the wheel well area. There are two (2) push pins that will need to be removed in this area. Both are located above the screw.



2. Gently pull the wheel well liner back. Remove the push pin that is located along the lower, outside edge.



3. Remove the one (1) screw and one (1) push pin that are on the under side of the vehicle, right ahead of the front tire.



4. Remove the four (4) push pins that are located under the vehicle. There are two (2) on the passenger's side and two (2) on the driver's side.

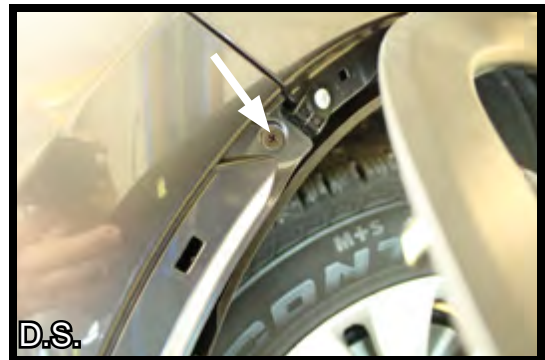

5. Carefully pry the wheel well trim back slightly. With a Phillips screwdriver remove the one (1) screw that is located towards the top portion of the wheel well.



6. Pull the front fascia up and outward to remove. Apply slight pressure as this does not pull away easily.

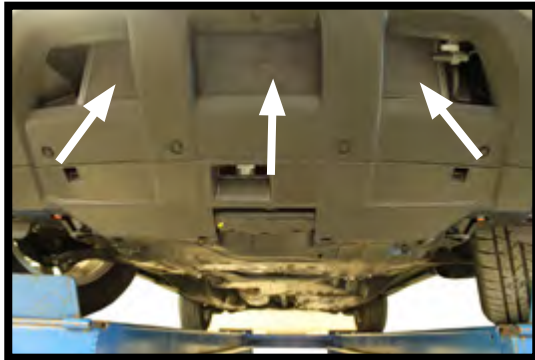
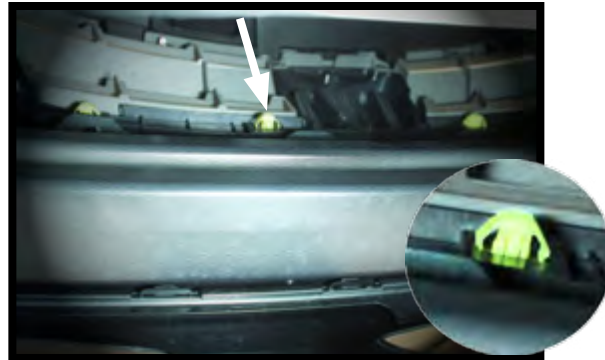

7. Look underneath the vehicle and toward the bumper to locate the four (4) yellow clips. Do this only to visually see where the clips are as you will be releasing them from the front side of vehicle. There are two (2) additional tabs on each side of the center of the bumper.

Reach up thru the opening and pull out the grill slightly to release the clips. To do this, first squeeze together the front tabs and pull to release the clip. Next, pinch the side tabs together and lift up.

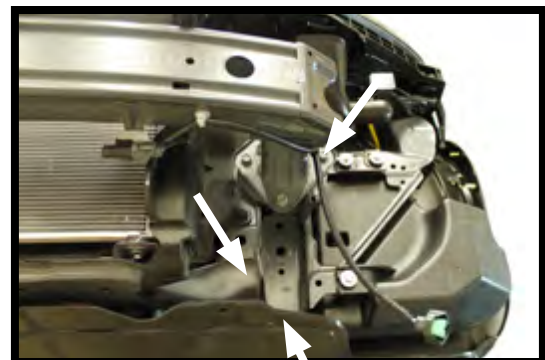

8. Using a 12MM socket, remove the four (4) bolts on the bumper core. There is one (1) on the top, one (1) on each side and one (1) on the bottom. Do this on both the sides of the vehicle.

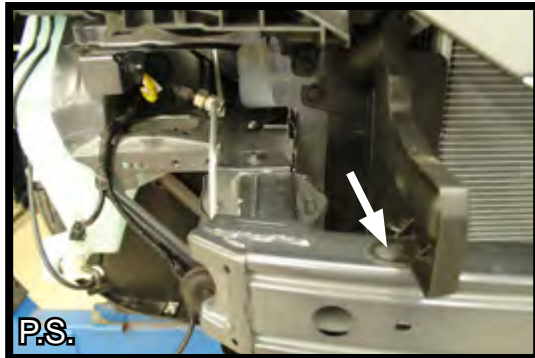

9. Using a flat screwdriver, remove the screw located on the top, outer edge of the bumper core. The bumper core will not get reinstalled.

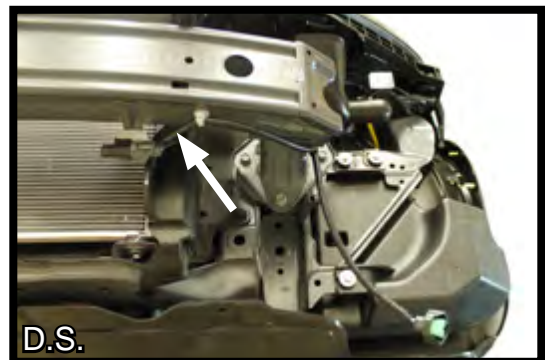

10. On the passenger side, remove the screw on the bottom, outer edge of the bumper core. On the driver side, the temperature sensor will need to be temporarily removed by releasing the push pins. It will be relocated once the baseplate installation is complete.



11. On the passenger side, cut straight down to remove the bottom portion. On the driver side, notch up 2-1/2" and straight out.

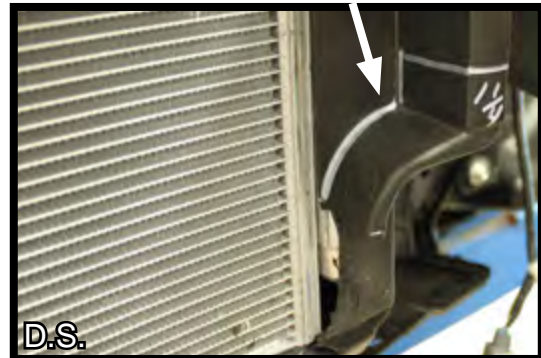
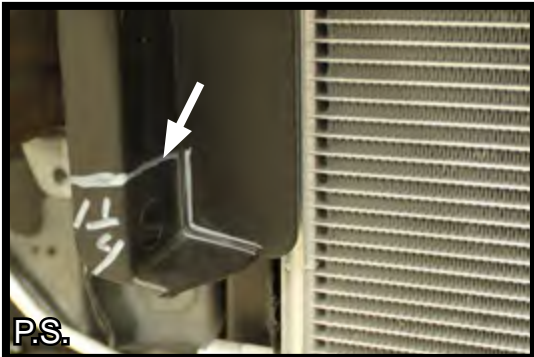

12. Additional cutting is required on the rubber mounts located next to the radiator. Mark each per image above and notch accordingly.

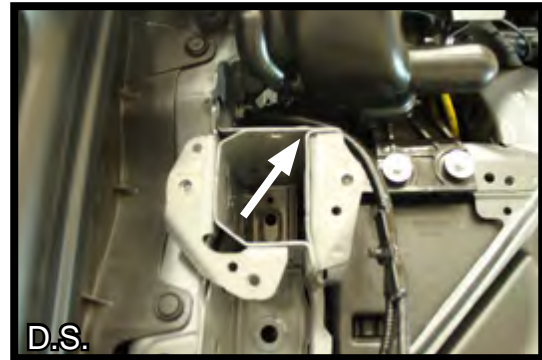

13. Using a chisel, remove the nut in order to slide the baseplate in.

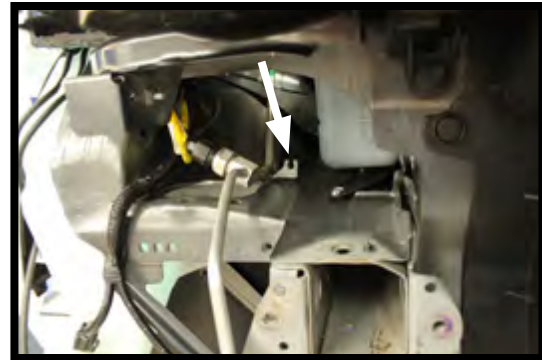
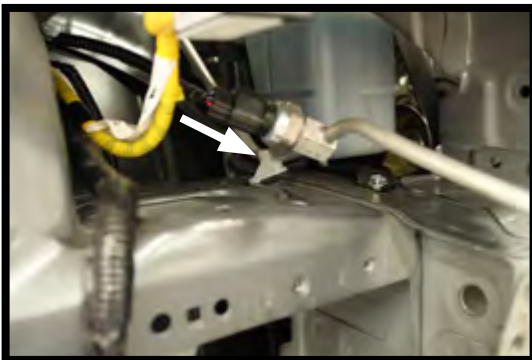

14. On the passenger side snap the coolant line out of the bracket and carefully move over and out of the way.



15. Slide the tubes of the baseplate assembly into the rectangular tube on the vehicle frame.

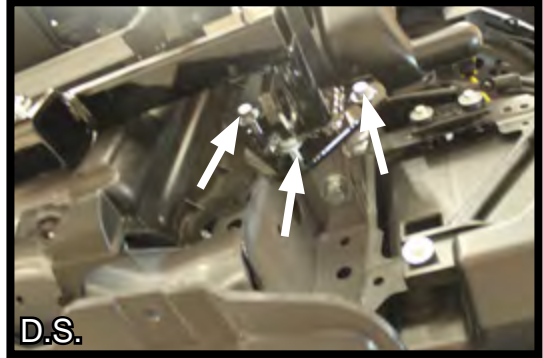
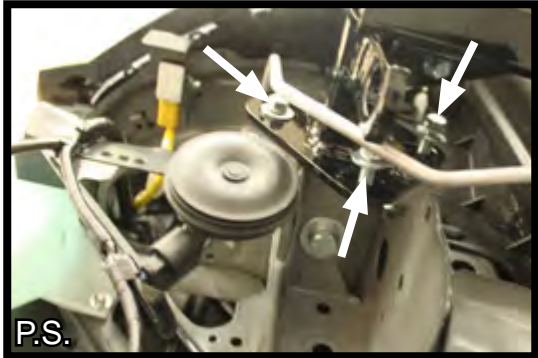

16. Align the bolt holes. Insert the three (3) 8MM-1.25 x 30MM bolts, 8MM lock washers and 8MM flat washers. Do not tighten at this time. Once all the fasteners have been started and the plate is properly aligned tighten all fasteners securely.

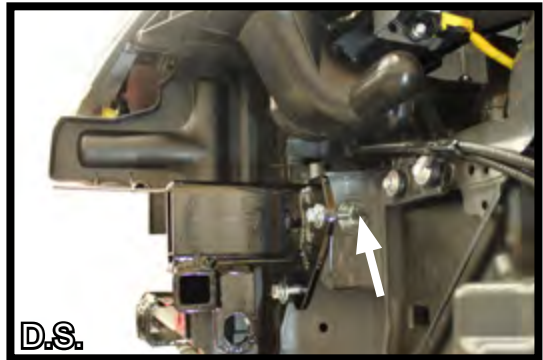
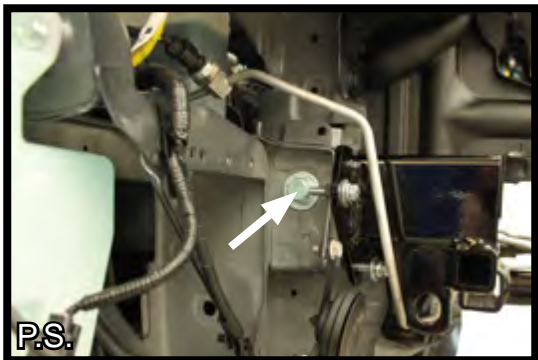

17. Insert one (1) 1/2"-13 x 1-1/2" bolt and 1/2" lock washer into the side hole. Use one (1) of the 1/2"-13 nut plates to fasten securely.

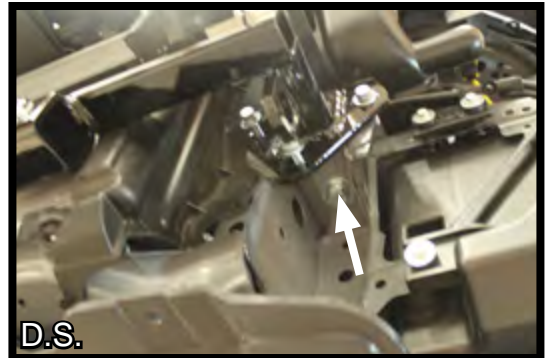
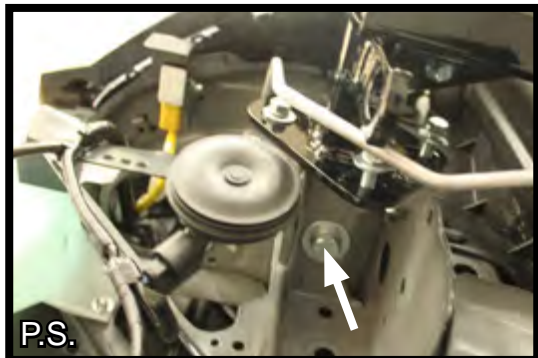

18. Insert a 1/2"-13 x 1-1/2" bolt and 1/2" lock washer, this hole may need to be reamed out slightly. Use one (1) of the 1/2"-13 nut plates to fasten securely.

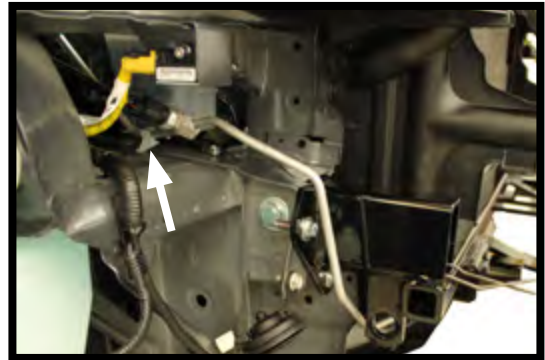
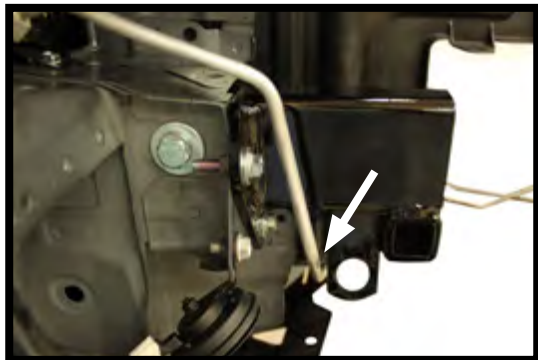

19. Make sure the coolant line does not interfere with the attachment tab. Snap coolant line back into bracket.

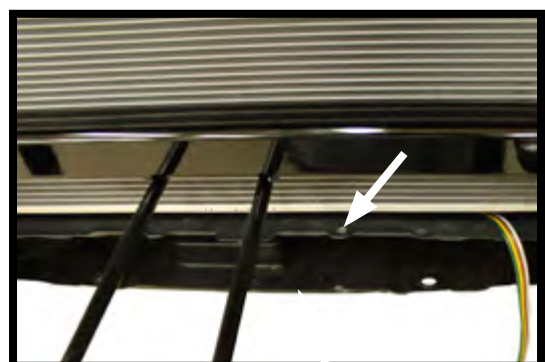
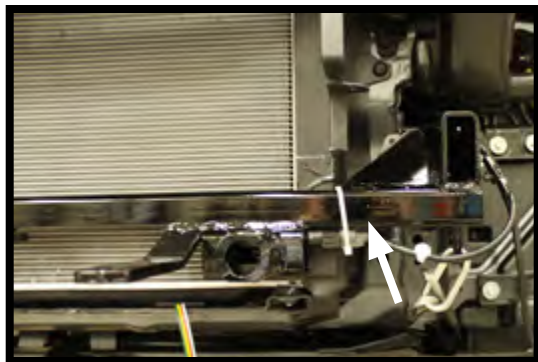

20. Using the cable tie that was provided, relocate the temperature sensor by attaching it to the baseplate.

21. To install a breakaway switch, drill a hole to the side of the electrical rods. Be sure to place a piece of metal on top of the frame rail to prevent accidentally drilling thru the radiator.



BX2258

2012-13 Honda CR-V Installation Instructions

22. Verify all bolts are fastened securely.



23. Attach the permanent baseplate safety cables to the provided convenience link on the baseplate. Additional options may interfere with suggested mounting; in this case, secure the cables to a solid piece of the frame as described in the instructions included with the permanent baseplate safety cables. Be sure the safety cables do not rub against any hoses and/or moving parts. Do this on both sides of the vehicle.

CUSTOMER SERVICE COMMITMENT

Blue Ox® is committed to providing you with exceptional customer care throughout your lifetime with our products. Our team is here to assist you with any questions you may have regarding the performance of your product. Simply call (402) 385-3051 and you can speak with our customer care team.

Additionally, please visit our website to see which rallies our Destination America team will be attending. For a nominal fee, our service technician will service your towing system to ensure it's in proper working condition. Also, as a commitment to our customers, should you visit our factory, you can stay at our full service Blue Ox® campground at no charge along with enjoying a factory tour.

Again, thank you for being our customer and for the confidence you have shown in the performance of our products. It is because of customers like you we enjoy the success we have today.



© 2012 Blue Ox
One Mill Road, Industrial Park
Pender, Nebraska 68047
Phone: (402) 385-3051
Fax: (402) 385-3360
www.blueox.com