

2007-10 Hyundai Elantra
(No Touring)

Installation Instructions

Serial Number

Please read BOTH these Installation Instructions and the General Towing Instructions before attempting to install or operate this equipment.

1. Blue Ox® towing products and accessories are intended to be installed by Blue Ox® Dealers who are familiar with our products and have the equipment and knowledge to do “fit work.” When necessary, Blue Ox® Dealers can be found at www.blueox.com or by contacting our Customer Care Department at (402-) 385-3051.

Attachment Tab Height: 14 1/2”
Attachment Tab Width: 23”

2. Many Blue Ox® Baseplates are designed to use existing holes and hardware to mount the baseplate to the towed vehicle. Even though bolts are there, do not assume they are adequate for baseplate mounting. Always use hardware supplied in the hardware kit or existing hardware specified in the Baseplate Towing Installation Instructions.

Bolt Torque Specifications

Torque in Foot-Pounds for Metric Bolts

Bolt Size	Grade 8.8	Grade 10.9
6MM	6	8
8MM	16	22
10MM	31	40
12MM	54	70
14MM	89	117

Confirm the towability and pre-towing procedures for your vehicle with the owner’s manual or contact the vehicle’s manufacturer for specific towing procedures.

Bolt Torque Specifications

Torque in Foot-Pounds for Inch Bolts

Bolt Size	Grade 5	Grade 8
1/4”	10	14
5/16”	19	29
3/8”	33	47
7/16”	54	78
1/2”	78	119
5/8”	154	230

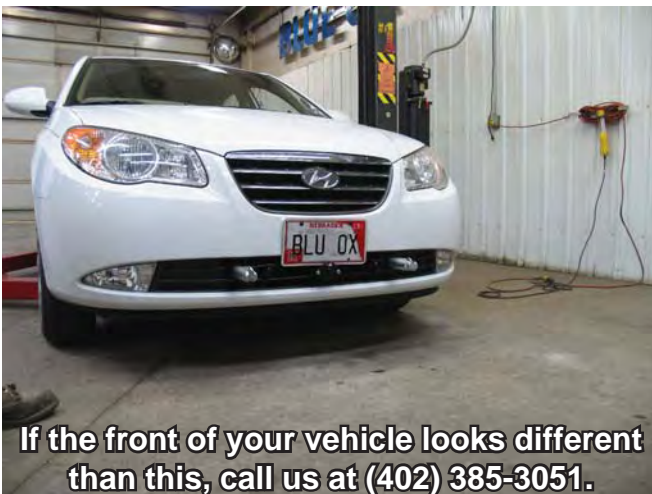

If the front of your vehicle looks different than this, call us at (402) 385-3051.

! WARNING

Failure to read and follow these instructions could result in separation of the towed vehicle from the tow bar, causing property damage, loss of towed vehicle, personal injury or death.

BX2325
2007-10 Hyundai Elantra
 (No Touring) Installation Instructions

Parts List

Ref. No.	Qty.	Part #	Description
1	1	61-6360	Weldment, Baseplate, BX2325
2	4	61-5208	Weldment, Nut Plate, 1/4x1x1, 3/8 Bolt w/10" Wire
3	4	201-0368	3/8-16x1 1/4 Hex Head Bolt, Grd. 5
4	4	201-0443	3/8-16x1 Hex Bolt, Grd. 5, ZP
5	4	203-0010	3/8 Lock Washer, ZP
6	4	202-0090	3/8-16 Hex Nylon Lock Nut, ZP
7	1	201-0655	6MM-1.0x30MM Hex Bolt, Grd. 8.8, ZP
8	1	203-0008	1/4 Lock Washer, ZP
9	1	203-0001	1/4 Flat Washer, ZP
10	2	201-0553	1/4-20x1/2" Hex WSHD, Type F Screw
11	2	201-0192	#10-32x1/2" Slot, Round Head Screw
12	2	203-0054	#10 Lock Washer
13	2	202-0047	#10-32 Hex Nut
14	2	101-5822	Adapter, 4 Way Connector
15	2	62-3468	Attachment, Assembly, SF/SB, 1 Hole
	2	290-0437	Cap Plug, Black (Not Shown)
	2	229-0359	Quicklink, 3/8", ZP (Not Shown)
	2	226-0046	Baseplate Safety Cable, 36" Class III (Not Shown)

Tools Required

Loctite® RED
 Spray Paint
 Vise Grips
 Utility Knife
 Reciprocating Saw
 Phillips Screwdriver
 10MM Socket
 9/16" Socket
 13/32" Drill Bit
 1 1/4" Hole Saw

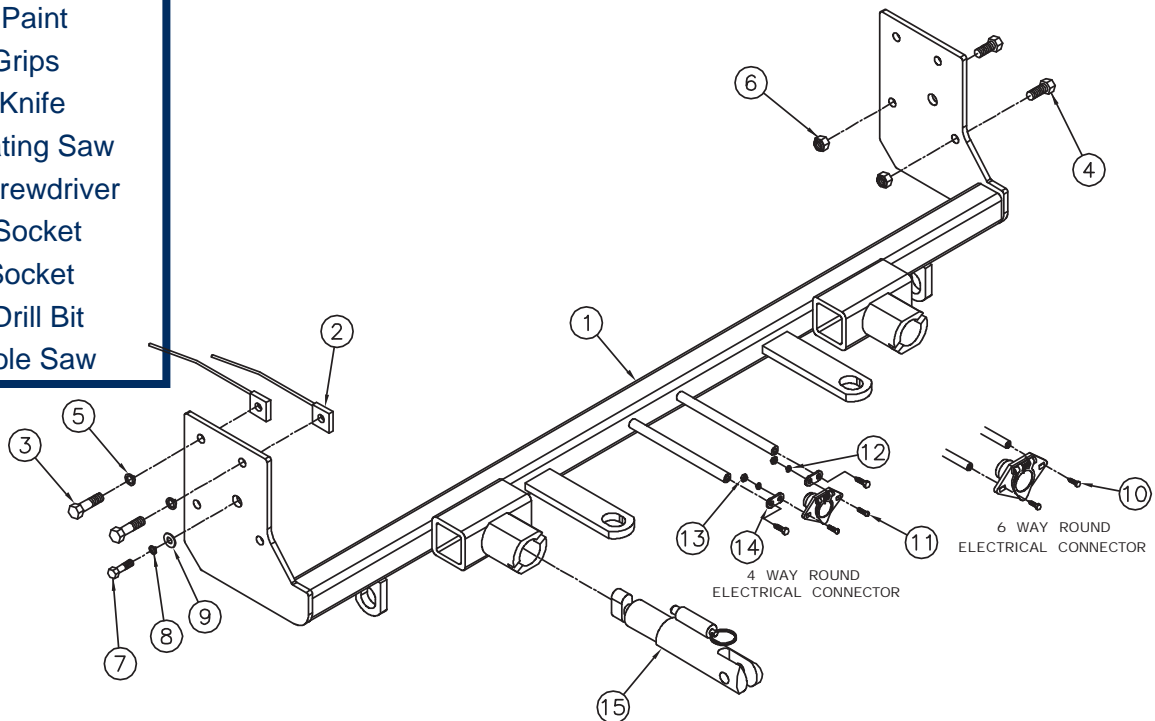

Important:

Use only genuine factory replacement parts on your baseplate. Do **NOT** substitute homemade or non-typical parts. If a bolt is lost or in need of replacement, for your safety and the preservation of your baseplate, be sure to use a replacement bolt of the same grade (In most cases it will be Grade 5, please reference the parts list above). Replacement parts may be ordered through your nearest Blue Ox® Dealer or Distributor. Failing to follow and/or altering these installation instructions in either installation or required equipment will void the manufacturer's warranty. Towing behind a non-motorized vehicle will void the warranty.

BX2325

2007-10 Hyundai Elantra (No Touring) Installation Instructions

Vehicle Weight:

Due to the design of the removable tabs, the RangeFinderII, Adventurer and Ambassador tow bars can not be used. Adapters, except the BX8833 and BX88151, can not be used with this baseplate.

Installation Notes: The fascia and belly pan are removed and reinstalled during installation of the baseplate. Drilling is required. Trimming of the fascia is required.

The dimensional variations between otherwise identical vehicles can be considerable. While the baseplate was designed for easy installation, it may be necessary to tailor the baseplate slightly to compensate for auto manufacturer's tolerances. These minor adjustments may include filing a hole slightly, bending electrical rods or bending end plates.

The BX8848 Diode Wiring Kit is recommended for this vehicle.

Handling of some cosmetic parts when installing this product may require the use of protective covers, rags, specialty tools, etc. to prevent damage.

Installation Instructions:



1. Using a 10MM socket, remove five metric bolts from the belly pan. Set belly pan and bolts aside to be reinstalled later.



2. Using a 10MM socket, remove two metric bolts from the air intake housing. Set bolts aside to be reinstalled later.

2007-10 Hyundai Elantra (No Touring) Installation Instructions



3. Using a Phillips screwdriver, remove two plastic Phillips pushpins located near the air intake housing. Do this to both sides of the vehicle. Set pushpins aside to be reinstalled later.



4. Using a Phillips screwdriver, remove one plastic Phillips pushpin just forward of the front tire, on the wheel well. Do this to both sides of the vehicle. Set pushpin aside to be reinstalled later.



5. Using a Phillips screwdriver, remove three plastic Phillips pushpins from just forward of the front tire along the bottom edge of fascia. The fascia is then ready to be removed from the vehicle by pulling fascia ends out to the side to release and then pulling it forward. Do this to both sides of the vehicle. Set fascia and pushpins aside carefully to be reinstalled later.

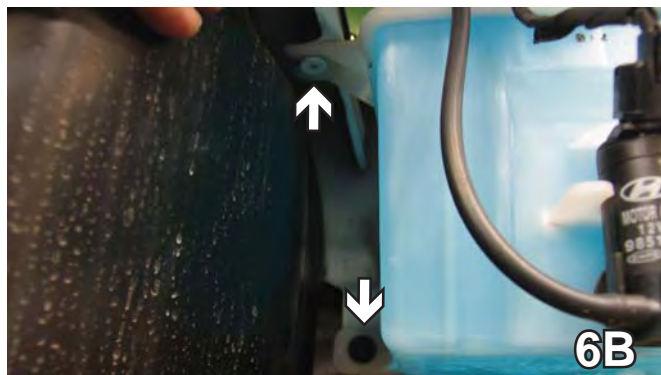
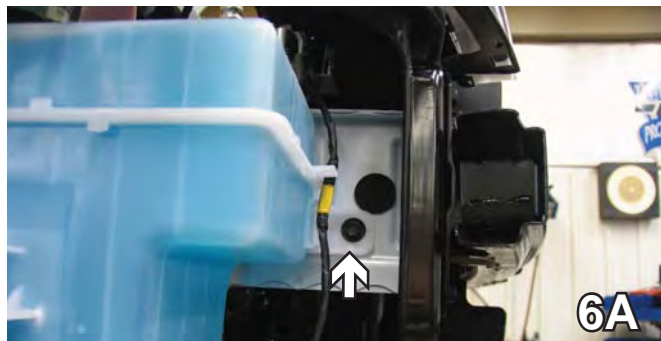

6. Remove water reservoir from passenger side, by using a 10MM socket to remove two metric bolts and by loosening up a Phillips screw. Set water reservoir and bolts aside to be reinstalled later.

BX2325

2007-10 Hyundai Elantra (No Touring) Installation Instructions



7. Using a utility knife, remove plastic guard by cutting along white dashed line indicated in photo above. Do this to both sides of the vehicle.

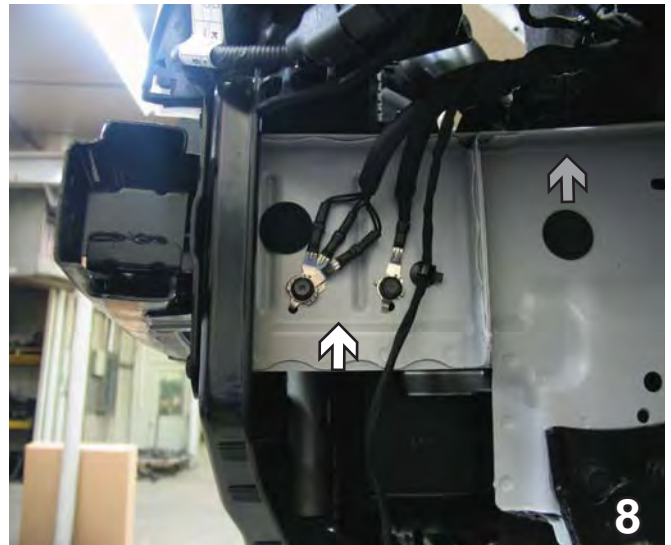

8. You will need to relocate the ground wires located on the drivers side (see white arrows), to the area indicated by the grey arrow.



9. Using a reciprocating saw, trim out area below bumper according to the photo above. You will need to measure in 1 3/4" from the side of frame and just below metal bumper. Remove this area from both sides.



10. Using a reciprocating saw, remove plastic area (see white arrows) located on the back of the fascia behind the running lights. Do this to both sides of the fascia.

BX2325
2007-10 Hyundai Elantra
(No Touring) Installation Instructions



11. Using a 1 1/4" hole saw, drill a hole in the bottom of the frame for the nut plates. Do this to both sides of the vehicle.

When using power drills be aware of the dangers of torque and drill bit length.

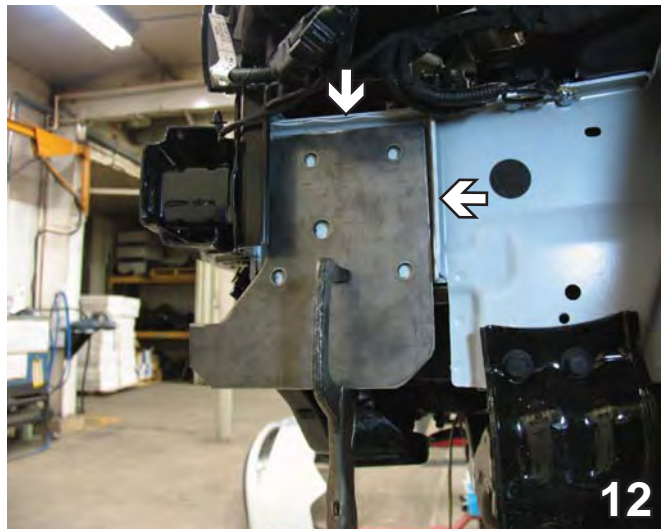

12. Slide baseplate up so it measures 3/16" down from top of frame and the back of the baseplate is straight with the frame. Clamp the baseplate into place with vise grips. Do this to both sides of the vehicle.

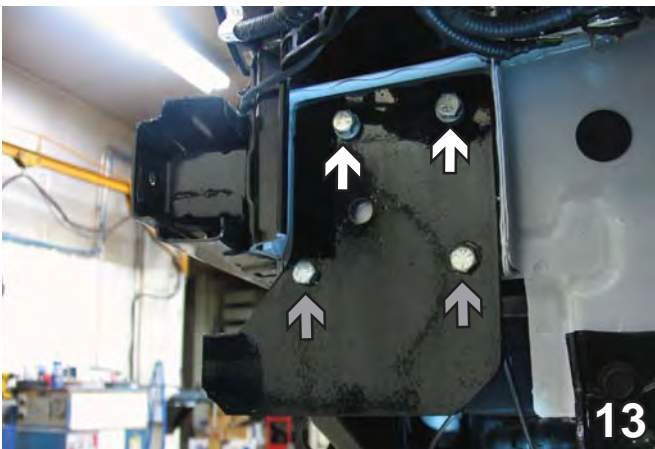

13. Using the baseplate as a template, drill the two bottom and top holes. Insert the nut plates into the bottom of the frame and align with top drilled holes. Insert a 3/8-16x1 1/4" hex bolt and 3/8 lock washer into the top two holes and tighten down (see white arrows). Insert a 3/8-16x1" hex bolt into the bottom two holes and tighten down with a 3/8-16 hex nylon lock nut (see grey arrows). Do this to both sides of the vehicle.

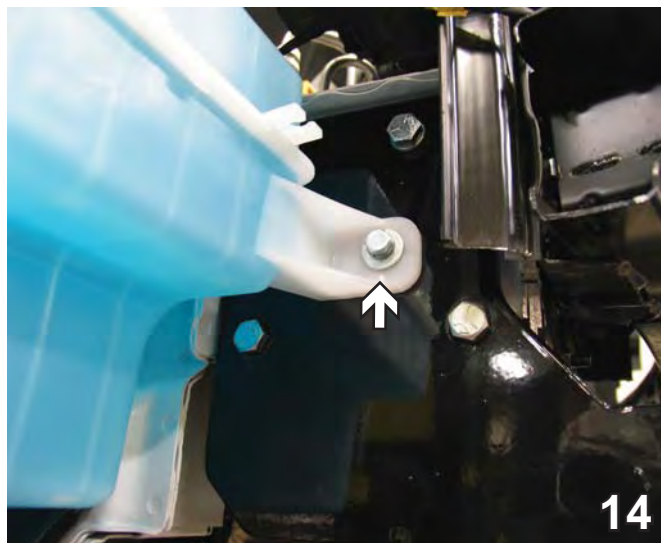

14. Reinstall the water reservoir, by inserting a 6MM-1.0x30MM hex bolt, 1/4" lock washer and 1/4" flat washer into the existing hole shown on baseplate. Use existing bolt removed in Step 6, to tighten down opposite side.

BE SURE TO USE LOCTITE® RED ON ALL BOLTS BEFORE TIGHTENING. TIGHTEN ALL BOLTS ACCORDING TO THE TORQUE CHART ON THE FRONT PAGE OF THESE INSTRUCTIONS OR ON PAGE 3 OF THE BASEPLATE TOWING GENERAL INSTRUCTIONS.

2007-10 Hyundai Elantra (No Touring) Installation Instructions

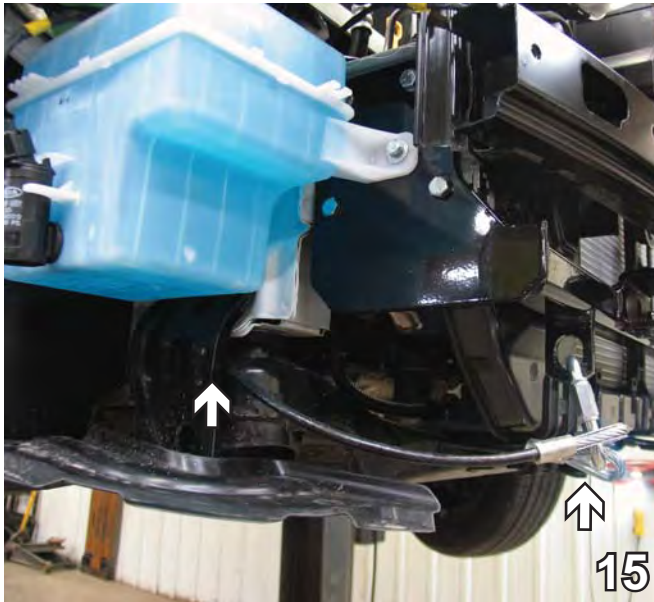

15. Attach the permanent baseplate safety cables to the provided convenience link on the baseplate. The photo above shows the recommended installation of the cables to frame of vehicle. Additional options may interfere with suggested mounting; in this case secure the cables to a solid piece of the frame as described in the instructions included with the permanent baseplate safety cables. Be sure the safety cables do not rub against any hoses or moving parts. Do this to both sides of the vehicle.

Be sure that **ALL** electrical connections are plugged in properly and functioning **BEFORE** installing the fascia.



16. Align the fascia to its original position, and using a hack saw blade, remove bar piece from grille as shown in photo above. You will also need to remove area outlined with white dashed lines. This is going to allow for attachment tab receiver to come through. Do this to both sides of the vehicle.

DEALER or INSTALLER:
Be certain the user receives the instruction sheets for their products.

Install the tow bar and safety cables according to the instructions provided in their packages. When demonstrating this to the customer, be sure to include all the contents and packages.

Do **NOT** substitute other devices if the tow bar pins and clips are misplaced.

BX2325
2007-10 Hyundai Elantra
(No Touring) Installation Instructions



Shown without removable tabs installed.

CUSTOMER SERVICE COMMITMENT

Blue Ox is committed to providing you with exceptional customer care throughout your lifetime with our products. Our team is here to assist you with any questions you may have regarding the performance of your product. Simply call (402) 385-3051 and you can speak with our customer care team.



Shown with removable tabs installed.

Additionally, please visit our website to see which rallies our Destination America team will be attending. For a nominal fee, our service technician will service your towing system to ensure it's in proper working condition. Also as a commitment to our customers, should you visit our factory you can stay at our full service Blue Ox campground at no charge along with enjoying a factory tour.

Again thank you for being our customer and for the confidence you have shown in the performance of our products. It is because of customers like you we enjoy the success we have today.

If the baseplate is in an accident, it must be replaced. DO NOT use it again! An accident can cause unseen damage and using it again could result in more damage or serious injury. DO NOT use the baseplate if it is damaged or missing parts.



© 2007, 08, 09, 10 Blue Ox
One Mill Road, Industrial Park
Pender, Nebraska 68047
Phone: (402) 385-3051 • Fax: (402) 385-3360
www.blueox.com