

2010-11 Hyundai Elantra
Touring
Installation Instructions

Serial Number

Please read BOTH these Installation Instructions and the General Towing Instructions before attempting to install or operate this equipment.

1. Blue Ox® towing products and accessories are intended to be installed by Blue Ox® Dealers who are familiar with our products and have the equipment and knowledge to do “fit work.” When necessary, Blue Ox® Dealers can be found at www.blueox.com or by contacting our Customer Care Department at (402-) 385-3051.

Attachment Tab Height: 15”
Attachment Tab Width: 20”

2. Many Blue Ox® Baseplates are designed to use existing holes and hardware to mount the baseplate to the towed vehicle. Even though bolts are there, do not assume they are adequate for baseplate mounting. Always use hardware supplied in the hardware kit or existing hardware specified in the Baseplate Towing Installation Instructions.

Bolt Torque Specifications

Torque in Foot-Pounds for Metric Bolts

Bolt Size	Grade 8.8	Grade 10.9
6MM	6	8
8MM	16	22
10MM	31	40
12MM	54	70
14MM	89	117

Confirm the towability and pre-towing procedures for your vehicle with the owner’s manual or contact the vehicle’s manufacturer for specific towing procedures.

Bolt Torque Specifications

Torque in Foot-Pounds for Inch Bolts

Bolt Size	Grade 5	Grade 8
1/4”	10	14
5/16”	19	29
3/8”	33	47
7/16”	54	78
1/2”	78	119
5/8”	154	230

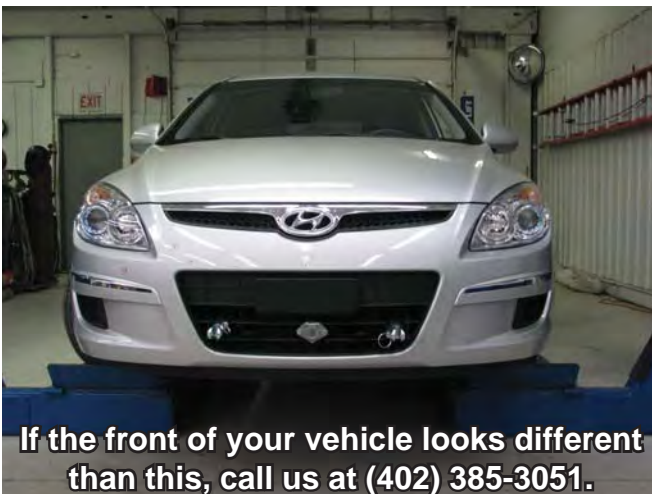

If the front of your vehicle looks different than this, call us at (402) 385-3051.

! WARNING

Failure to read and follow these instructions could result in separation of the towed vehicle from the tow bar, causing property damage, loss of towed vehicle, personal injury or death.

BX2328 2010-11 Hyundai Elantra Touring

Installation Instructions

Parts List

Ref. No.	Qty.	Part #	Description
1	1	61-6748	WLDM'T, BP, BX2328
2	6	61-5208	WLD, NUT PLT, 1/4X1X1, 3/8"/14"WIRE
3	2	101-7548	PLATE, SUPPORT, BX2328
4	1	102-7081	FLAT, 3/8 X 2 X 5"(2-Ø.562)
5	6	201-0495	10MM-1.25 X 45MM HEX BLT,GRD.8.8 ZP
6	6	203-0104	10MM LOCK WASHER, ZP.
7	6	201-0368	3/8-16 X 1 1/4 HEX HEAD BOLT,GRD. 5
8	6	203-0010	3/8 LOCK WASHER, ZP
9	2	201-0011	1/2-13 X 1 1/4 HEX BOLT GRD.5, ZP
10	2	201-0283	1/2-13 X 2 HEX BOLT, GRD 5, ZP.
11	4	203-0012	1/2 LOCK WASHER, ZP
12	4	202-0094	1/2-13 HEX NYL. INS. LOCK NUT, ZP
13	2	201-0553	1/4-20 X 1/2 HX.WSHD.TYPE F TCS, ZP
14	2	201-0192	10-32 X 1/2 SLOT, RD. HD. SCREW
15	2	203-0054	#10 LOCK WASHER
16	2	202-0047	#10-32 HEX NUT
17	2	101-5822	ADAPTER, 4 WAY CONNECTOR
18	2	62-3468	ATT TAB ASSY, REM, SF/SB, 1 HOLE
	2	201-0050	1/4-20 X 3/4 HEX BOLT GRD.5, ZP (Not Shown)
	2	202-0069	1/4-20 HEX FLANGE WHIZ LOCK NUT, ZP (Not Shown)
	2	290-0437	RECEIVER, CAP PLUG (BLK) (Not Shown)
	2	229-0359	QUICKLINK, 3/8, ZP (Not Shown)
	2	226-0046	BASEPLATE SAFETY CABLE, .36" CL III (Not Shown)

Tools Required

8MM Socket	Drill
10MM Socket	Phillips Screwdriver
14MM Socket	Utility Knife
7/16" Socket/Wrench	Pliers
9/16" Socket/Wrench	Tape Measure
3/4" Socket/Wrench	1 1/4" Hole Saw
Large Vise Grip	13/32" Drill Bit
Needle Nose Pliers	5/16" Drill Bit
Reciprocating Saw	17/32" Drill Bit
	Loctite® RED

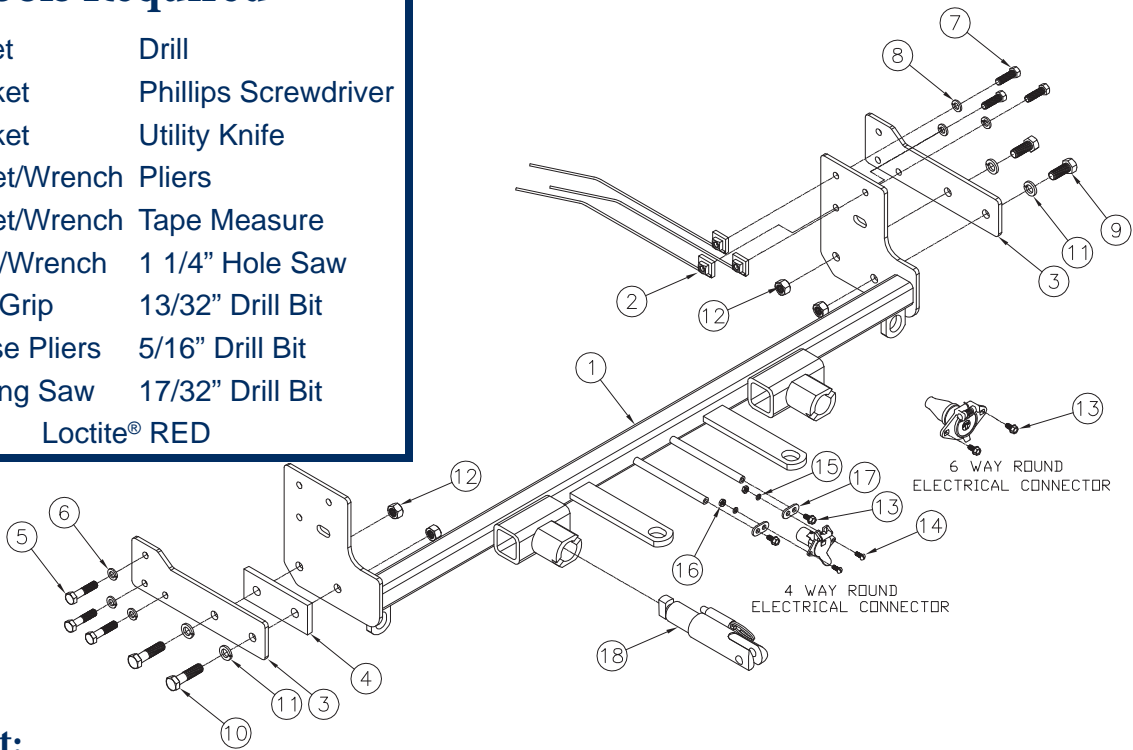

Important:

Use only genuine factory replacement parts on your baseplate. Do **NOT** substitute homemade or non-typical parts. If a bolt is lost or in need of replacement, for your safety and the preservation of your baseplate, be sure to use a replacement bolt of the same grade (In most cases it will be Grade 5, please reference the parts list above). Replacement parts may be ordered through your nearest Blue Ox® Dealer or Distributor. Failing to follow and/or altering these installation instructions in either installation or required equipment will void the manufacturer's warranty.

2010-11 Hyundai Elantra Touring

Installation Instructions

Vehicle Weight:

The weight of this vehicle is near the Class III, 5,000 lbs. rating limitations. Some models, depending on options, may well exceed this 5,000 lb. rating. Be sure to confirm the weight of your individual vehicle before towing. As of 1999 the Aventa® II is now rated 10,000 lbs. and either the Aventa® II or the Aventa® LX tow bar must be used for these applications.

Tow Bar Adapters are NOT to be used with vehicle's weighing over 5,000 lbs.

Installation Notes: The fascia and belly pan are removed and reinstalled during installation of the baseplate. Drilling is required. Trimming of the fascia is required.

The dimensional variations between otherwise identical vehicles can be considerable. While the baseplate was designed for easy installation, it may be necessary to tailor the baseplate slightly to compensate for auto manufacturer's tolerances. These minor adjustments may include filing a hole slightly, bending electrical rods or bending end plates.

The BX8869 Bulb & Socket Wiring Kit is recommended for this vehicle.

Handling of some cosmetic parts when installing this product may require the use of protective covers, rags, specialty tools, etc. to prevent damage.

Installation Instructions:

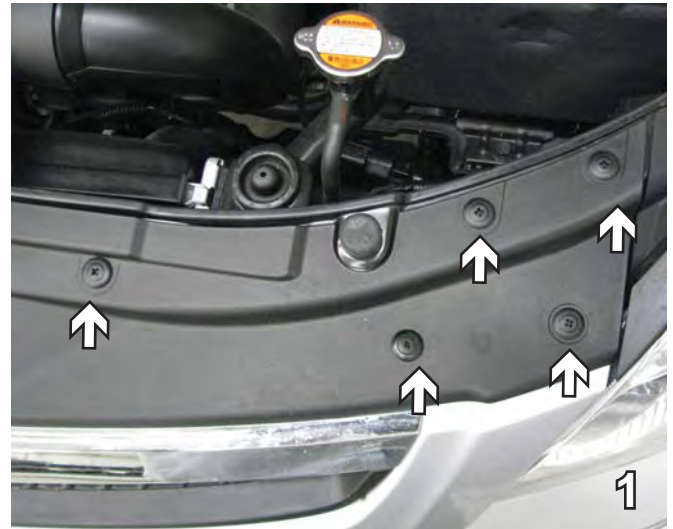

1. Using a Phillips screw driver, remove five plastic push pins from the top front of the fascia. Set pins aside to be reinstalled later. Do this to both sides of the vehicle.



2. Using a 10MM socket, remove two metric bolts from the air intake housing. Set bolts aside to be reinstalled later.

BX2328

2010-11 Hyundai Elantra Touring

Installation Instructions



3. Using a 8MM socket or a Phillips screwdriver, remove one screw just forward of the front tire, on the wheel well. Do this to both sides of the vehicle. Set screws aside to be reinstalled later.



4. Using a 10MM socket, remove five metric bolts from the belly pan underneath the vehicle. Set belly pan and bolts aside to be reinstalled later.



5. Using a Phillips screwdriver, remove three plastic Phillips pushpins from just forward of the front tire along the bottom edge of fascia. The fascia is then ready to be removed from the vehicle by pulling fascia ends out to the side to release and then pulling it forward. Do this to both sides of the vehicle. Set fascia and pushpins aside carefully to be reinstalled later.

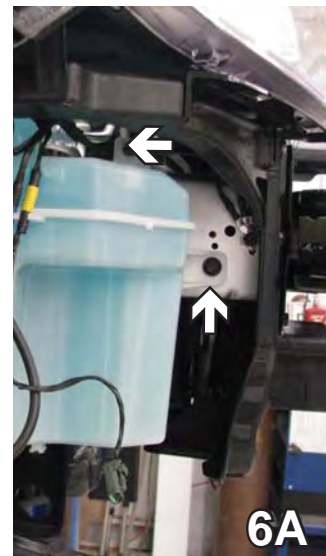
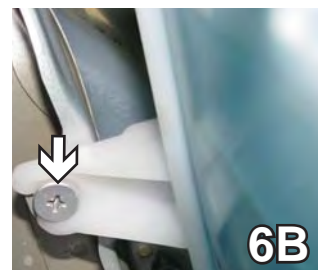
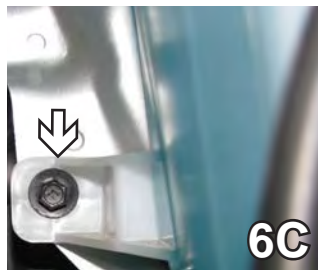

6. On the passenger side moving from top right clockwise, remove the wire clips from the top tab to release the wires. Using a 10MM socket remove two metric bolts, one on each side. Use a Phillips screw driver to loosen the screw on the top left. Disconnect all wires and hoses, plug the hoses. Set the washer reservoir and bolts aside to be reinstalled later.

2010-11 Hyundai Elantra Touring

Installation Instructions

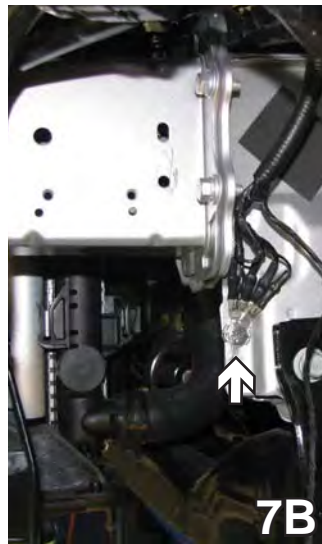

7. Relocate the ground wires, as shown in 7A to 7B. Using a 5/16" drill bit drill a hole, attach the ground wires with a 1/4-20 x 3/4" bolt and a 1/4-20 whiz nut on the back. Do this to both sides of the vehicle.

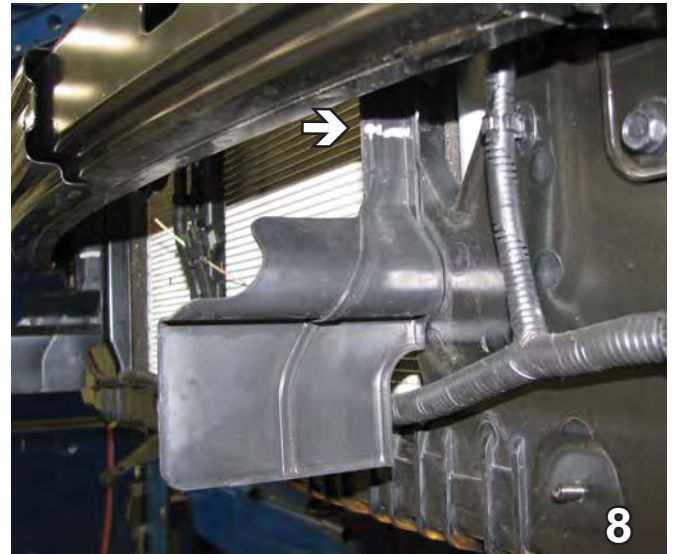

8. Using a utility knife, remove plastic guard by first cutting flush with the bottom of the bumper. Do this to both sides of the vehicle.



9. Using a 10MM socket, remove the bolt holding the plastic guard in place. Do this to both sides then remove the guard.



10. On the driver's side, unfasten the two clips holding the wire. Move the wire out of the way as trimming will need to be done to the frame.

BX2328

2010-11 Hyundai Elantra Touring Installation Instructions

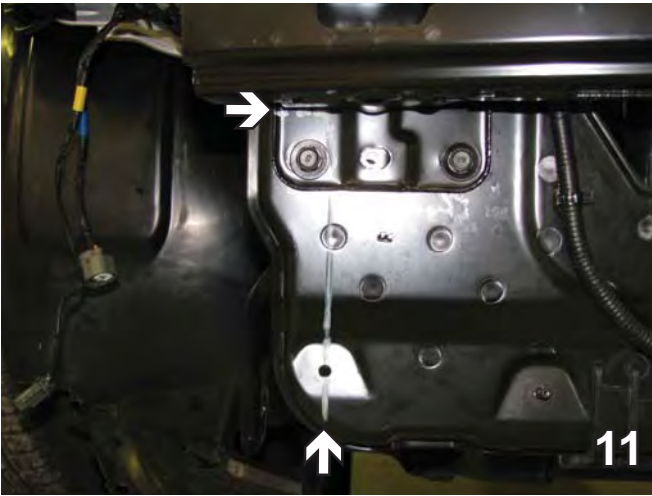

11. Using a reciprocating saw, trim out the area below the bumper. Measure in 1 3/4" from the side of frame below the metal bumper. Cut under the bumper then straight down. Remove this area from both sides.

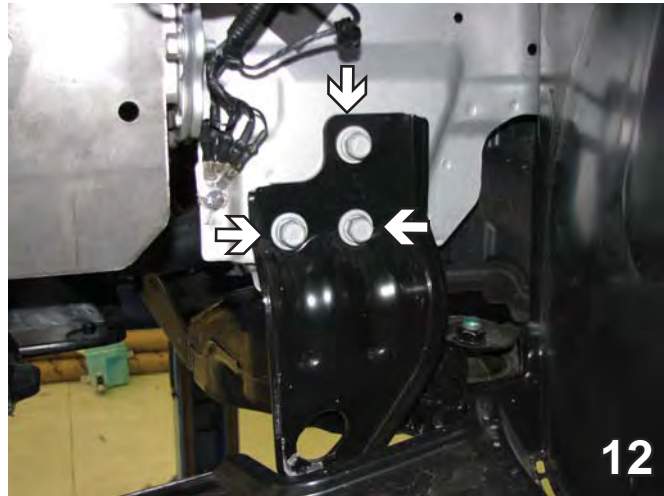

12. Using a 14MM socket, remove the three bolts holding the tow hook. Do this to both sides of the vehicle. Set aside to be reinstalled later.

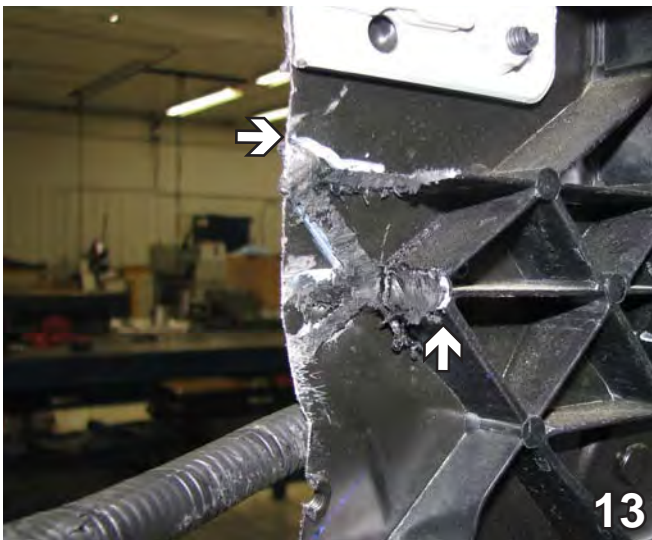

13. On the back side of the plastic piece remaining in step 11, cut from the top straight down the center. Then trim away the backing to leave a flat surface. Remove this area from both sides.

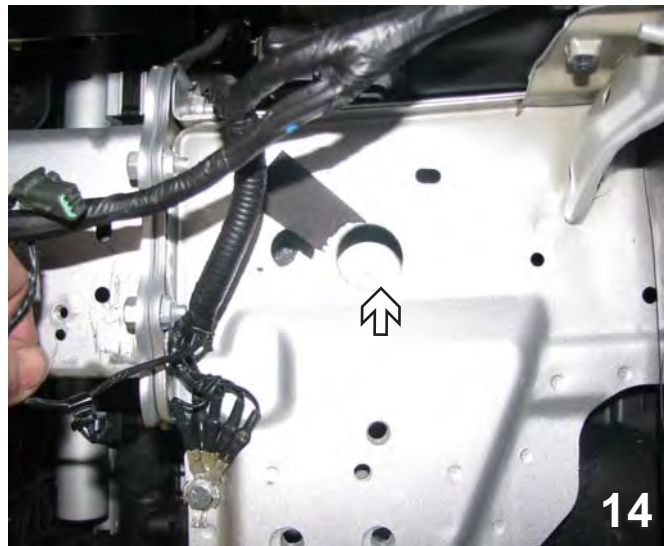

14. Using a 1 1/4" hole saw, drill a hole in the bottom of the frame for the nut plates. Do this to both sides of the vehicle.

When using power drills be aware of the dangers of torque and drill bit length.

2010-11 Hyundai Elantra Touring

Installation Instructions

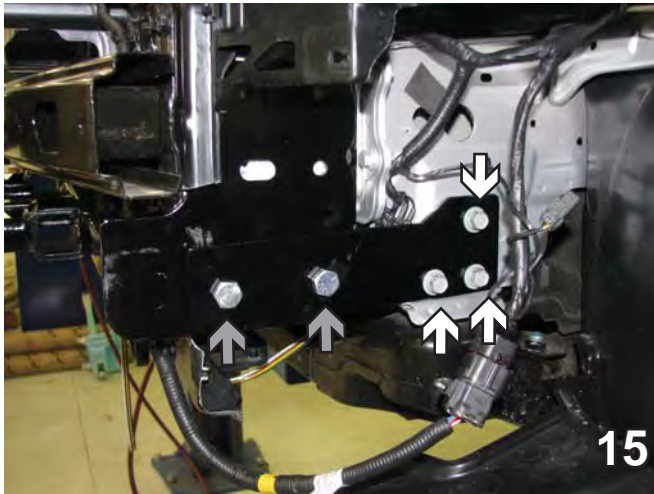

15. Slide baseplate up so it is level with the frame. Clamp the baseplate into place with vise grips. Put the support plates on and start the three existing bolts. Align the two holes with the baseplate. Do this to both sides of the vehicle. On the driver side, insert 1/2-13 x 1 1/4" bolts with 1/2" lock washers and tighten with 1/2-13 lock nuts on the inside. On the passenger side, insert the spacer flat between the baseplate and the support plate and insert 1/2-13 x 2" bolts with lock washers and nuts.

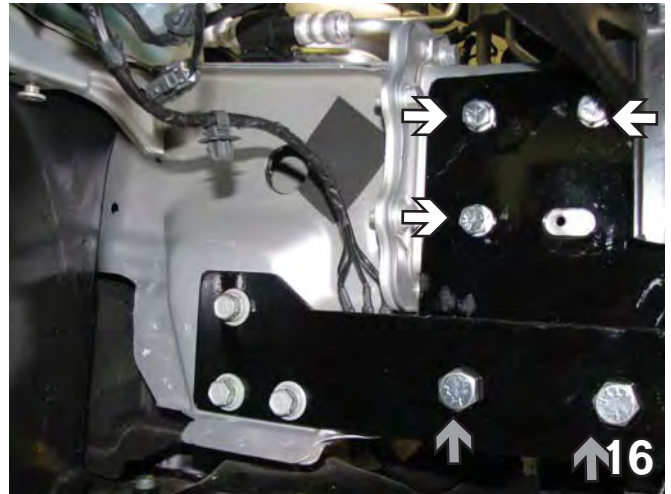

16. Using the baseplate as a template, drill the three holes. Insert the nut plates into the frame and align with 3/8-16 x 1 1/4" hex bolts and 3/8 lock washers and tighten. Reattach the two bolts on the bottom and tighten. (see grey arrows). Be sure to use loctite on all bolts. Do this to both sides of the vehicle.

BE SURE TO USE LOCTITE® RED ON ALL BOLTS BEFORE TIGHTENING. TIGHTEN ALL BOLTS ACCORDING TO THE TORQUE CHART ON THE FRONT PAGE OF THESE INSTRUCTIONS OR ON PAGE 3 OF THE BASEPLATE TOWING GENERAL INSTRUCTIONS.

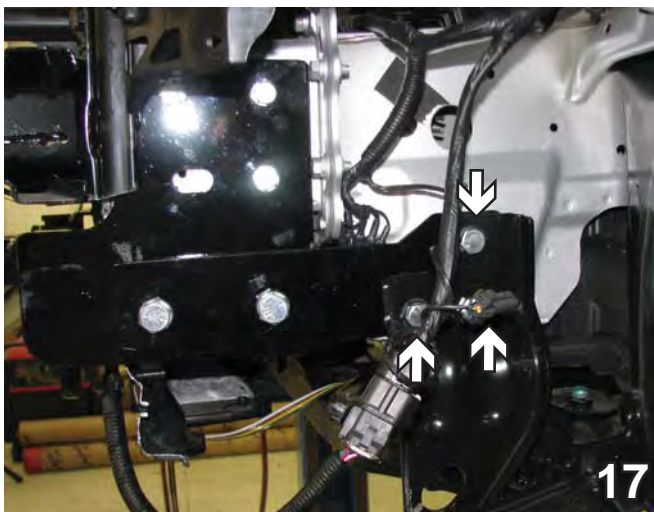

17. Remove the existing three bolts and replace tow hooks. Fasten with 10MM-1.25 x 45MM hex bolts and 10MM lock washers and tighten. Be sure to use loctite on all bolts. Do this on both sides of the vehicle.



18. On the passenger side, reinstall the washer reservoir by inserting the existing bolts removed in Step 6. Reattach hoses and wires.

BX2328

2010-11 Hyundai Elantra Touring Installation Instructions



19. Attach the permanent baseplate safety cables to the provided convenience link on the baseplate (see grey arrow). The photo above shows the recommended installation of the cables to frame of vehicle (see white arrow). Additional options may interfere with suggested mounting; in this case secure the cables to a solid piece of the frame as described in the instructions included with the permanent baseplate safety cables. Be sure the safety cables do not rub against any hoses or moving parts. Do this to both sides of the vehicle.

Be sure that **ALL** electrical connections are plugged in properly and functioning **BEFORE** installing the fascia.

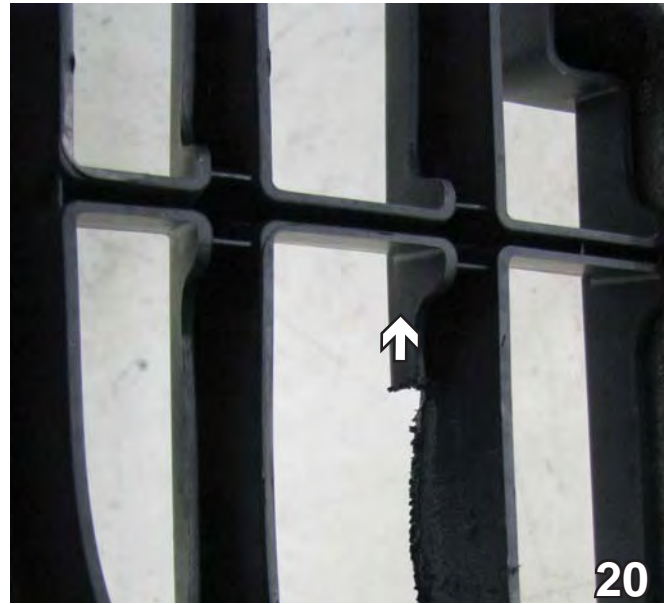

20. Align the fascia to its original position, and mark the area needing to be removed for the attachment tab receiver to come through. On the back side of the fascia remove the area. Do this to both sides of the vehicle.

DEALER or INSTALLER:
Be certain the user receives the instruction sheets for their products.

Install the tow bar and safety cables according to the instructions provided in their packages. When demonstrating this to the customer, be sure to include all the contents and packages.

Do **NOT** substitute other devices if the tow bar pins and clips are misplaced.

BX2328

2010-11 Hyundai Elantra Touring Installation Instructions



Shown without removable tabs installed.



Shown with removable tabs installed.

If the baseplate is in an accident, it must be replaced. DO NOT use it again! An accident can cause unseen damage and using it again could result in more damage or serious injury. DO NOT use the baseplate if it is damaged or missing parts.

CUSTOMER SERVICE COMMITMENT

Blue Ox is committed to providing you with exceptional customer care throughout your lifetime with our products. Our team is here to assist you with any questions you may have regarding the performance of your product. Simply call (402) 385-3051 and you can speak with our customer care team.

Additionally, please visit our website to see which rallies our Destination America team will be attending. For a nominal fee, our service technician will service your towing system to ensure it's in proper working condition. Also as a commitment to our customers, should you visit our factory you can stay at our full service Blue Ox campground at no charge along with enjoying a factory tour.

Again thank you for being our customer and for the confidence you have shown in the performance of our products. It is because of customers like you we enjoy the success we have today.



© 2010, 11 Blue Ox
One Mill Road, Industrial Park
Pender, Nebraska 68047
Phone: (402) 385-3051 • Fax: (402) 385-3360
www.blueox.com