



# Installation Instructions

## *Console Hammer Shifter*

### *1994-2000 Ford Mustang*

*Part Number 81001*

© B&M Racing & Performance Products LLC 2000

The **B&M Mustang Console Hammer** shifter is a full ratchet shifter that is designed to fit 1994 to 2000 Ford Mustangs with AODE automatic transmissions. Unlike other Hammer shifters, this shifter not only ratchets between all of the forward gears but also ratchets into Reverse and Park. It has a lockout, controlled by the trigger, to keep from unintended shifts into Reverse or Park. It is designed to work with the ignition interlock and the brake interlock installed in these vehicles. This shifter is designed to work with the existing Ford shifter cable and the existing neutral safety switch and backup light switch.

Please read the instructions and review the illustrations thoroughly before beginning the installation.

The mechanical components of this shifter are precision made and assembled at our factory. Any modification or disassembly of these parts can cause the shifter to malfunction and will void the warranty. You should disassemble only those items outlined in the instructions.

**IMPORTANT:** This shifter is designed to work with the steering column lock on your car. Be sure that it is connected to the shifter and properly adjusted, so that the steering column only be locked and the key removed

when the shifter is in Park and so that the transmission cannot be shifted out of Park unless the key is turned on. Some Mustangs are also equipped with a brake interlock that prevents the shifter from being shifted out of Park unless the brakes are applied. If your vehicle is so equipped, this feature will also work with the **B&M Mustang Console Hammer** shifter. Check to be certain that the interlock operates cor-

rectly with the existing shifter. If it does not, it probably will not work with the **B&M Mustang Console Hammer** shifter. The interlock should allow you to turn the key to the locked position only when the shifter is in Park, and will not allow you to shift out of Park unless the key is turned out of the lock position (and the brakes are applied if your vehicle also has a brake interlock).

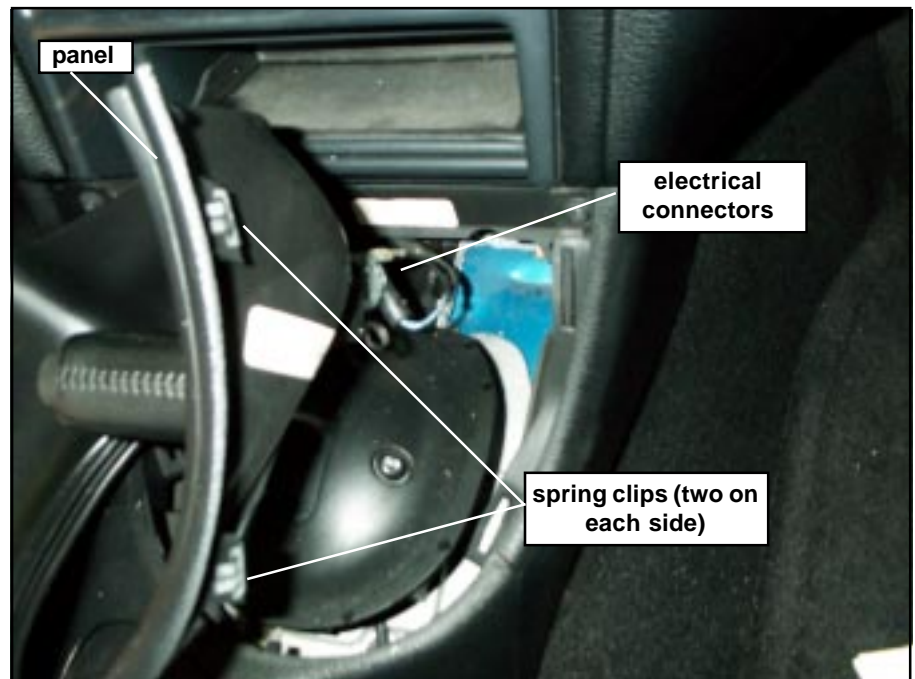

Photo #1

The vehicle should be about 2 feet off the ground for ease of installation. Use jack stands, wheel ramps or a vehicle lift. Make sure the vehicle is firmly supported before attempting to work on it.

### INSTALLATION

**STEP 1.** Remove the console. First place the shifter into the Neutral position then remove the panel around the stock shifter by carefully prying up from the spring clips. It is held in by four spring clips. Disconnect the electrical connectors (**See Photo #1**). Remove the console compartment underneath the arm rest. Remove the two screws hidden under the rubber plugs and pry up the console compartment (**See Photo #2**). Remove the four mounting screws (two at front of the console and two under the console compartment) and set them aside. Set the parking brake lever to the upright position. Remove the console panel and disconnect the wiring harness connectors.

**STEP 2.** From under the car disconnect the shifter cable from the shifter. The end of the cable snaps over a ball fitting on the shifter lever. This can be pried off with a screwdriver. The cable housing is attached to the shifter flange by two screws. On '99-'00 models, remove the plastic clip holding the shifter cable. Move the cable end away from the shifter so that it will not interfere with removing the shifter. Inside of the car, disconnect the interlock cable from the shifter. This is the 1/4" diameter black cable that goes from the front of the shifter under the dash board up to the steering column. Disconnect the center wire from the plastic bellcrank by carefully pulling up on it. It will snap out. Be careful not to bend the wire. The housing of the interlock cable is attached to the front of the shifter base plate with a screw and to the end of the pivot pin for the interlock bell crank with a clip. Remove both of these and disconnect the cable (**See Photo #3**). Disconnect the electrical connectors from the shifter.

**STEP 3.** Remove the stock shifter. It is held in by four screws that go into the nuts that are clipped over the edges of the opening in the tunnel. If any of the sealing gasket sticks to the tunnel, remove it. Peel the paper facing off of the supplied foam rubber gasket and stick it to the bottom of the **B&M** shifter being sure that the holes line up. Be sure that the four nuts that are clipped around the opening in the tunnel line up with the holes. Install the shifter and screw it down with the original screws. You will have to work the right hand edge of the shifter under the edge of the carpet. (If the original screws and nuts that hold the shifter

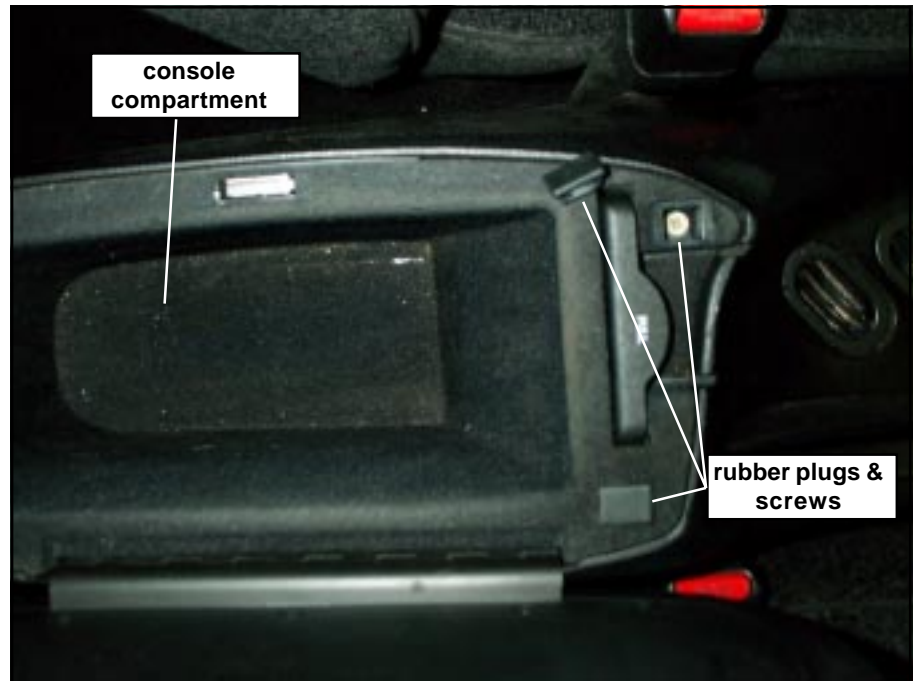

Photo #2

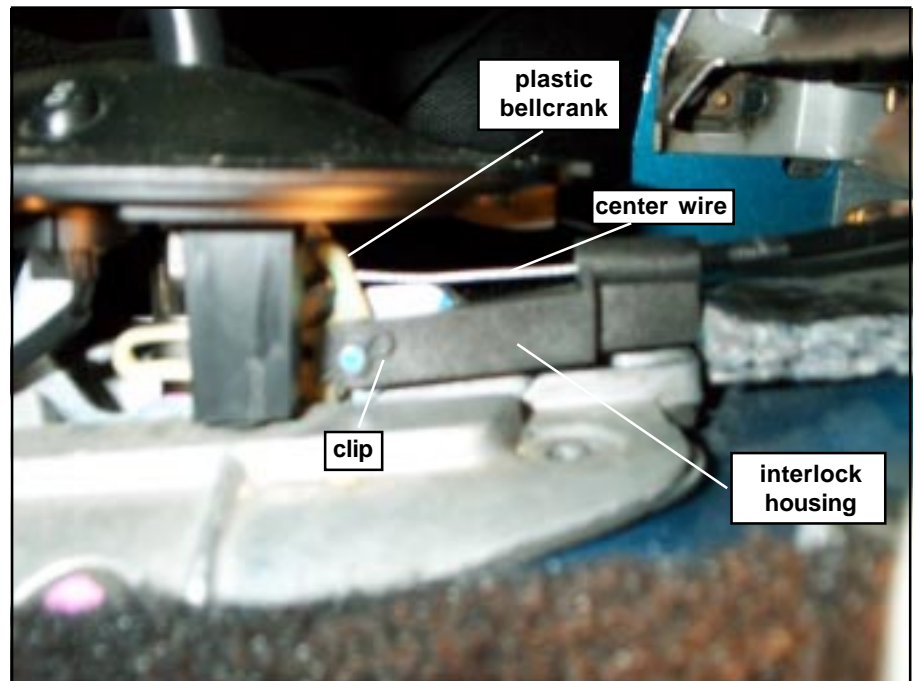
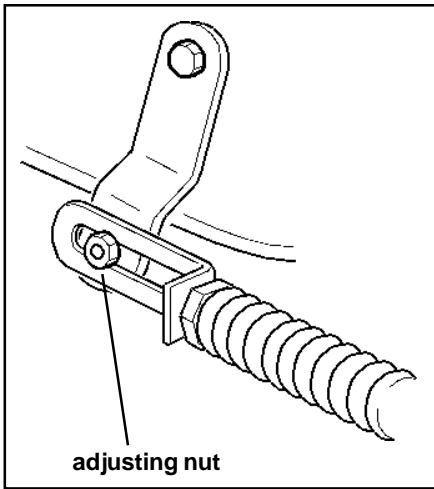

Photo #3

to the tunnel cannot be reused, replace them with 5/16" X 1" bolts, nuts and lock washers. Someone will have to be under the car to hold the nuts while they are tightened from the top). Screw the jam nut and the T-handle onto the end of the shifter stick to make it easier to shift during the adjustment procedures. The jam nut is a round nut with two flats on it. The chamfered side goes down.

**STEP 4.** Before connecting the shifter



**Figure #1**

cable to the shifter, loosen, but do not remove, the adjusting nut at the front end of the shifter cable where it connects to the transmission shift lever (**See Figure #1**). Move the transmission shift lever as far back as it will go, and then move it forward three clicks. This is the Neutral position. Move the shifter to the Neutral position. (See the Operation section at the end of these instructions). Connect the cable to the REAR side of the cable bracket on the shifter using the two self tapping 1/4" X 5/8" screws provided with the kit. On '99-'00 models you will need to use the adapter and spacer kit as shown in **Photo #4**. Snap the cable end over the ball on the shifter output lever. On '99-'00 models replace the ball with the cable pin and snap the cable in place. Tighten the adjusting nut on the shifter cable.

**STEP 5.** Check that the shifter is in the Neutral position. The transmission should also be in the Neutral position. With both the shifter and the transmission in the Neutral position, loosen the adjusting nut on the transmission shift lever at the front end of the shifter cable. Pull forward lightly on the cable to take up the free play in the cable and then tighten the nut while still maintaining tension on the cable. Check that the shifter will move to all the gear positions without having to use excessive force. (See the Operation section at the end of these instructions). Particularly check that the transmission lever moves to the Reverse position when the shifter is moved from Park to Reverse. If it does not, recheck the cable

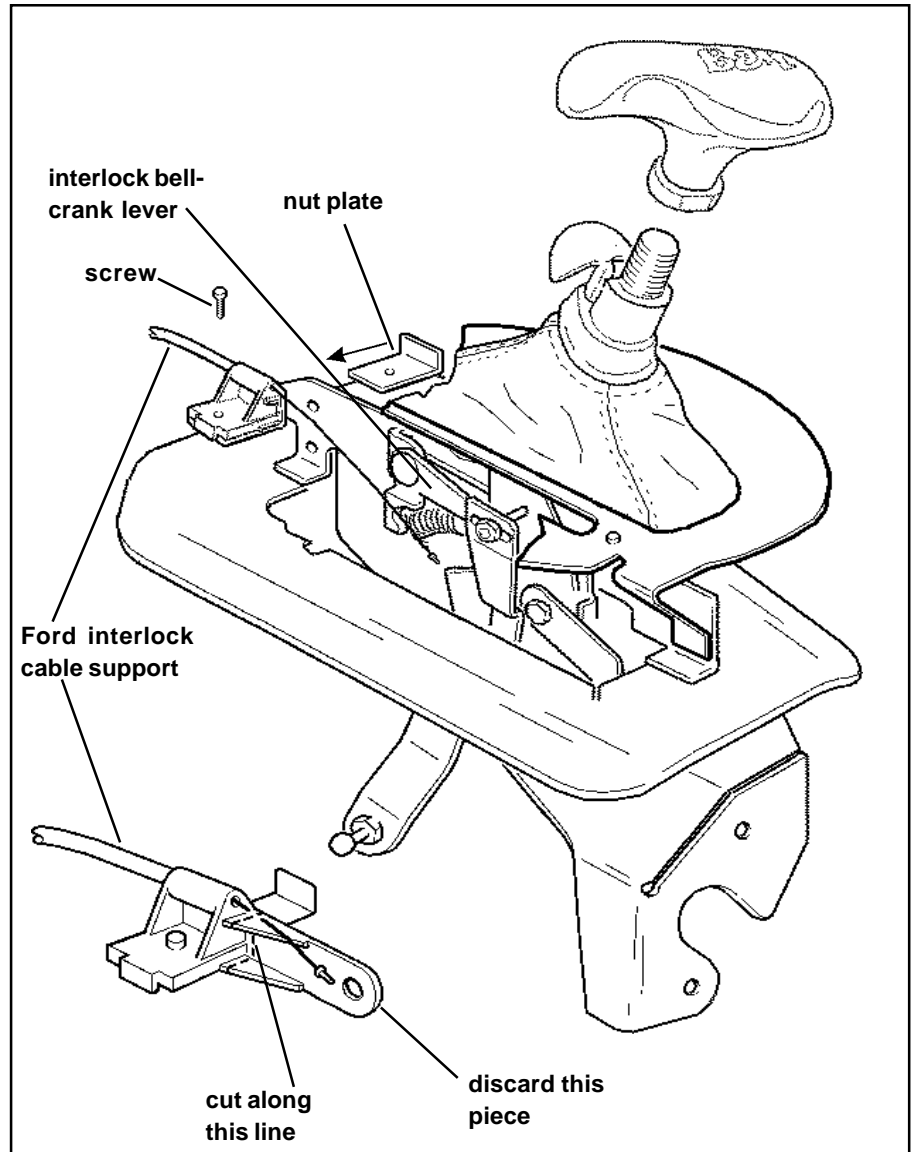

**Figure #2**

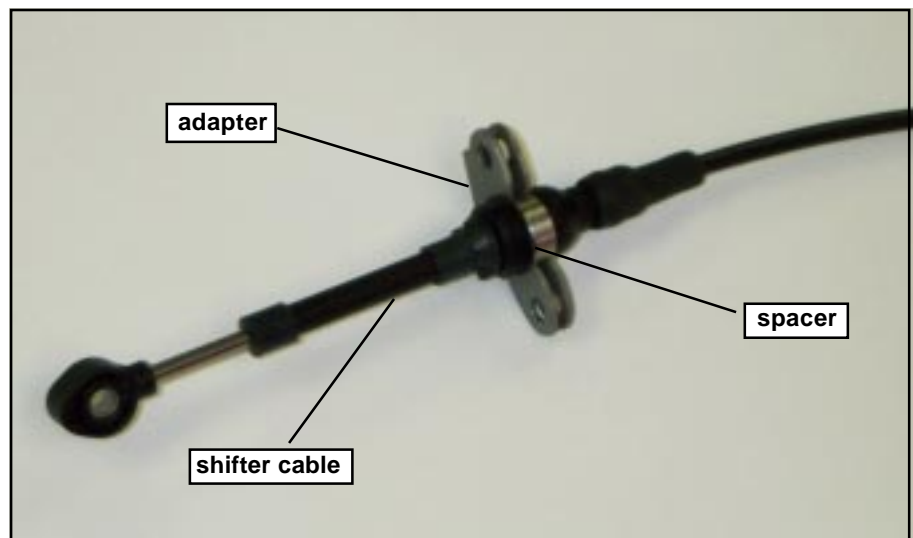

**Photo #4**

adjustment procedure above. If your shifter cable is well used it may have developed too much free play to work with this shifter. In that case you will need to replace it with a new Ford cable.

**STEP 6.** Turn the ignition key to the unlocked position, one notch clockwise from the locked position, and put the shifter into the Park position before installing the interlock cable. Cut the end off of the plastic interlock cable support as shown in **Figure #2**. Slip the end of the center wire of the interlock cable into the slot in the interlock bell crank. Attach the cable support to the base of the shifter using the supplied socket head 10-24 x 1/2" screw and nut plate (**See Figure #2**). Do not tighten the screw all the way, leave it loose enough so that the cable will slide back and forth in the slot.

**STEP 7.** Pull up the trigger on the shifter and ratchet it back one position into Reverse. Slide the interlock cable housing as far forward as it will go and tighten the screw holding the cable to the shifter. The shifter should now be able to be shifted to all positions. The ignition key should not be able to be turned to the locked position and the key removed in any shifter position except Park. With the key in the locked position or removed, you should not be able to pull the trigger on the shifter up far enough to be able to shift into reverse. When the key is turned to the unlock position, the trigger should be able to be pulled up and the shifter be able to shift into Reverse. If your car has a brake interlock system as well, you will have to apply the brakes as well as turning the key to the unlock position to be able to lift the trigger far enough to shift out of Park. If the interlock does not operate correctly, slide the cable backwards about 1/16" and retry. With small adjustments in the position of the cable you will be able to get the interlock to operate correctly. Once the interlock is operating correctly tighten the screw to keep the cable from moving. You cannot get to this screw once the console is installed.

**STEP 8.** Locate a wire in the console area that is hot anytime the ignition is turned on, and is off when the ignition

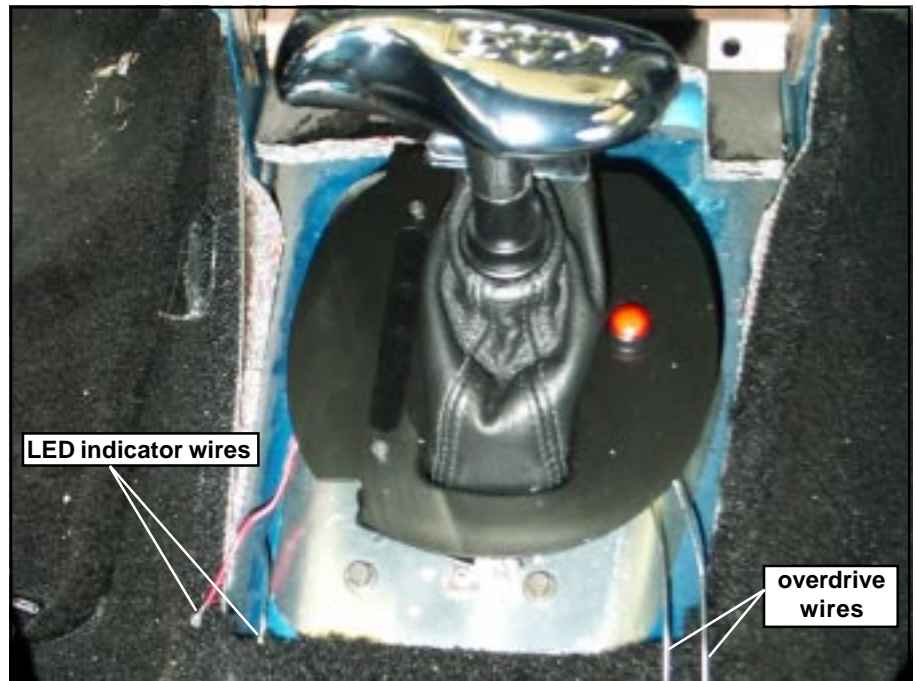

Photo #5

is off. The power feed to the radio is a possible choice. This wire will supply the current for the LED gear position indicator (**See Photo #5**). The LED must be illuminated when the ignition is on, because this is the only indication of what gear position the shifter is in. Do not use the wire that was originally used to illuminate the indicator on the stock shifter, since this is hot only when the lights are turned on. When you identify the hot wire splice in a length of wire long enough to reach the shifter plus about 6". Also run another piece of wire to a good ground. Be sure the ignition is off when splicing the hot wire and connect the red wire of the LED indicator to the hot wire and the black wire to the ground wire. Check that the LED is illuminated when the ignition is turned on and the wires are out of the way of the mechanism.

**STEP 9.** Locate the wires from the overdrive switch and splice in the wires from the new switch on the shifter (**See Photo #5**). The wires don't need to be connected in any specified order.

**STEP 10.** Before replacing the console, remove the T-Handle. Replace the console and reconnect the wiring to the console. Replace the four screws that secure the console to the tunnel and the dash board. Replace the console compartment with the two screws and the rubber plugs.

**STEP 11.** Replace the panel around the shifter and reconnect all the electrical connectors. Install the T-Handle and tighten the jam nut when the handle is properly oriented. Use a little loctite on the threads to keep the handle from turning. Check the operation of the shifter, indicator and interlock.

## OPERATION

The **B&M Mustang Console Hammer** is a ratchet shifter. You push the stick forward for up shifts and pull it back for down shifts. The ratchet shift allows firm, positive, no-miss upshifts and downshifts. Move the knob forward or backwards as far as it will go to select the next gear. Then let the spring return the stick to the central position. After you shift from Drive to Neutral the reverse lockout prevents the shifter from shifting any further (to prevent accidental selection of Reverse). To shift to Reverse lift the trigger up as far as it will go and then push the handle forward and release it. When you shift from Reverse into Park, the spring pushes the trigger back down. To shift out of Park to Reverse or any other gear it is necessary to lift the trigger first and then pull back on the handle. From reverse you can continue to ratchet backwards to Neutral and any of the forward gears.