



PRIOR TO INSTALLATION

- A) Bushwacker®** only approves installing the flares according to these written instructions with the hardware provided. **WARNING:** Failure to install according to these instructions will invalidate the warranty. This includes, but is not limited to using alternative installation methods, hardware, or materials. **DO NOT USE:** Loctite, SuperGlue, or similar products on the hardware or the flares.
- B) Custom Paint Job:** Please test fit all the flares first to ensure you have the correct flares for your vehicle. We are not responsible for any costs you may incur if you did not confirm the flares before having it painted. We recommend hiring professionals to custom paint the products. It is also ideal to have the painting done prior to the installation to eliminate any over-spraying issues.
- C) Remove existing fender flares.** (Skip this step if you don't have existing fender flares.)
Remove all the screws and fasteners currently holding the existing flare to the vehicle. Write down and save all the screws you have removed for re-use with the fender flares. If certain areas of the existing flares are held on with double sided tape, you will have to pry your existing flare off. Please do so carefully to avoid damage to your vehicle body.
- D) Test Fitting:** Hold each and every flare up to the fender. Make sure you align the flare to the contour of the body, and the mounting holes lineup to the existing mounting holes on the inner fender lip (if applicable). Don't worry if not all the holes line up, as some holes are meant to be used with different installation hardware that is provided. The flares may not be sitting flush at this time, our flares are designed to flex into the bodyline when you actually install them using the provided and existing hardware. At any time, do not drill or modify the fender flare in anyway, as you will void your warranty.
- E) Remove other existing parts.**
Some vehicles may require the removal of existing parts that will interfere with the installation. Common item would be mud flaps; however by using fender flares, they act as another form of mud deflector. If you are not confident in doing so, this will be a good time to take your vehicle to a professional for the installation. Save existing screws and fasteners from the vehicle. **NOTE:** For 2014 Silverado, must remove and discard factory mudflaps on front wheel wells. For rear wheel wells, must remove and discard the factory mudflaps attached to vehicle bed that are closest to the cab.
- F) Cleaning the vehicle.**
Make sure to wash your vehicle, especially the area the fender flares will be mounted to including the inner fender lip. Any dirt or debris that has not been cleaned or removed can potentially cause the improper fitment of the fender flare. If you are covering existing rust, we recommend sanding down the rust and

Forge™ Fender Flares Set of 4

Set Part #28119-08

I-Sheet #IBAF-119

Rev-2 03/25/2021

For complete fitment info visit : www.bushwacker.com

TOOLS FOR EASY INSTALLATION:

- Razor Blade
- Hex Key 4.0 and 4.5
- Socket Wrench
- Torx head screwdriver

PLEASE READ: Dirt and debris can become lodged between the fender flares and the vehicle's fenders, causing scratching and paint wear from vibration. Lund International is not responsible for any damage, and the installation of our fender flares is done with the buyer's understanding that this scratching and paint wear may occur.

LIMITED LIFETIME WARRANTY AGAINST ANY MANUFACTURING DEFECTS

- To claim a warranty, you must provide Proof of Purchase.

primer over to prevent further deterioration of the metal in the fender. Make sure the vehicle is dry before the installation. The fender flares come ready to be installed, however if you need to clean them, please use a mild detergent to wash and then dry completely.





G) For Rivet Installation:

Install the rivet screws and nuts to each of the rivet holes on the flare. Our rivets are designed to screw on to the fender flares only, and they shouldn't be touching the vehicle body at all. Using hand tools, tighten nuts until fastener is snug. **DO NOT OVERTIGHTEN** as this may damage the fender flare.

- H) Installation of the Rubber Seal:** Before you start cutting any rubber seal, please study the diagram. Do not use the rubber seal in any other areas other than indicated; otherwise you will end up with a shortage of rubber seal on your last flare. Start the installation of the rubber seal as indicated in the diagram. Then cut the rubber seal with a razor. Follow the same instruction for the remaining flares.

*Each roll of the rubber seal provided is long enough to complete the 4 fender flares and with extra to spare, however we are not responsible for the improper use of the rubber seal. Contact Bushwacker to purchase additional rolls of rubber seal.

Included in Hardware Kit:

- 
U-Clip
12 pcs
- 
Rubber Seal
- 
Rivet + Nylon Nut
32 pcs
- 
Offset Lever
Clip 4 pcs

Component List:

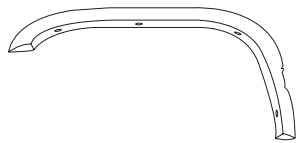

Left Front
Flare

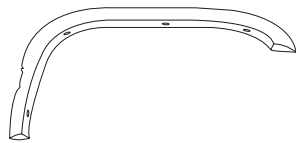

Right Front
Flare

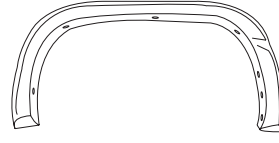

Left Front
Flare

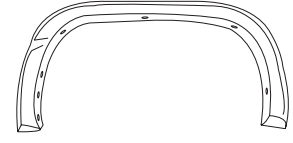

Right Front
Flare

Flare Installation Procedures:

1. Start with any fender flare you like. If parts have protective film applied, please remove it now. First, hold the flare against the fender. Make sure that all the body line is lined up, and insert the first mounting hardware towards the middle of the flare. That way it will hold up the flare.
2. Next, you will continue the installation of all the remaining hardware from the middle outwards. Before tightening any hardware, make sure the flare is lined up correctly.

TIP #1: It may be a good idea to line up all the necessary hardware in order on the floor next to the wheel so you will have easy access to them, which will help avoid any confusion and mistakes.

TIP #2: Push in on the flare while tightening hardware.

3. Finally, you will tighten the hardware fasteners. If it's a clip type, make sure the clips are firmly clipped into place, and that they lock into retention slots on the flare. (refer to the diagram for correct way to mount the hardware)
4. Now you can try to use your hand and lightly pry on the flare at the mounting location to see if any hardware is loose
5. Repeat the same steps for rest of the flares.

Flare Installation Procedures:

Front Flare

FRONT OF VEHICLE

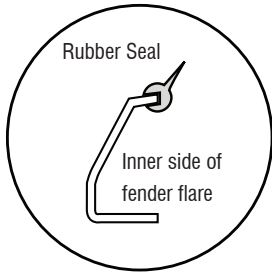

Rubber Seal

Inner side of fender flare

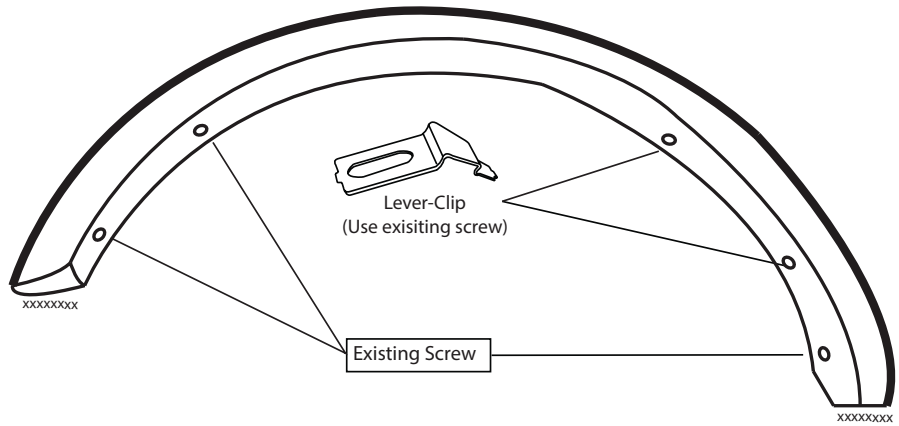

— Use Rubber Seal here
xxxxxxxx Do NOT use Rubber Seal here

Rear Flare

FRONT OF VEHICLE

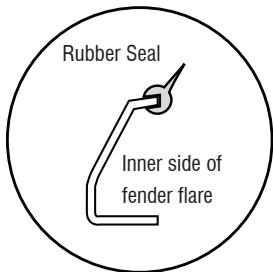

Rubber Seal

Inner side of fender flare

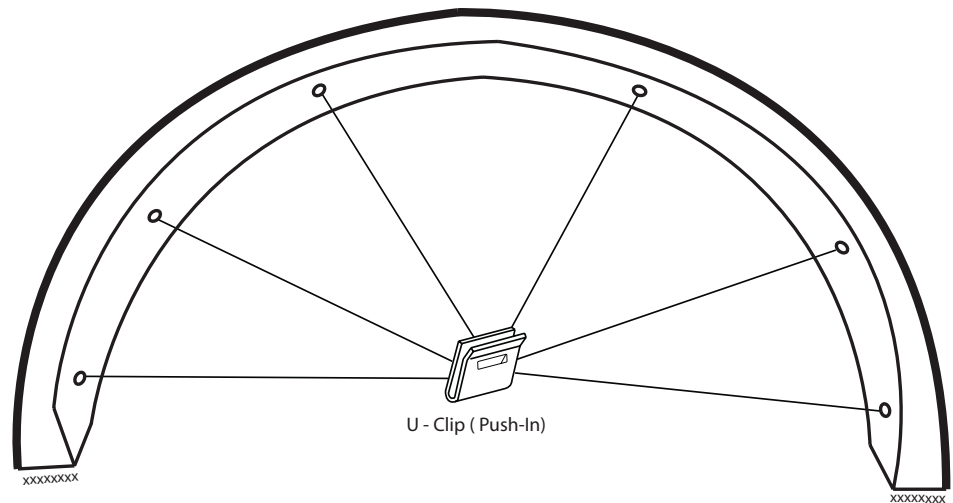

— Use Rubber Seal here
xxxxxxxx Do NOT use Rubber Seal here

Details

U-Clip Installation

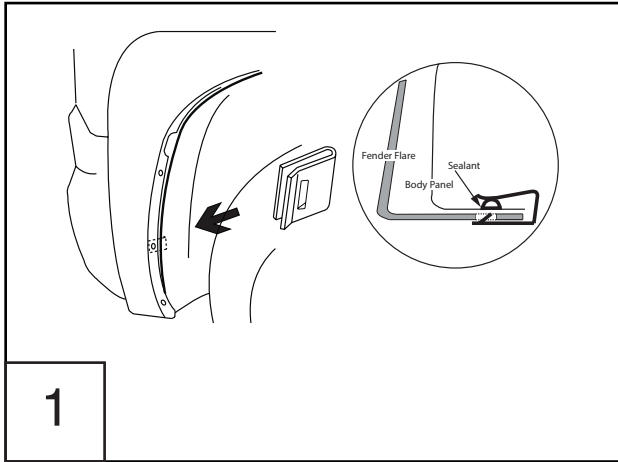

1

Due to building variations in trucks, it may be necessary to remove some sealant from inner lip of fender to allow installation on U-Clips.

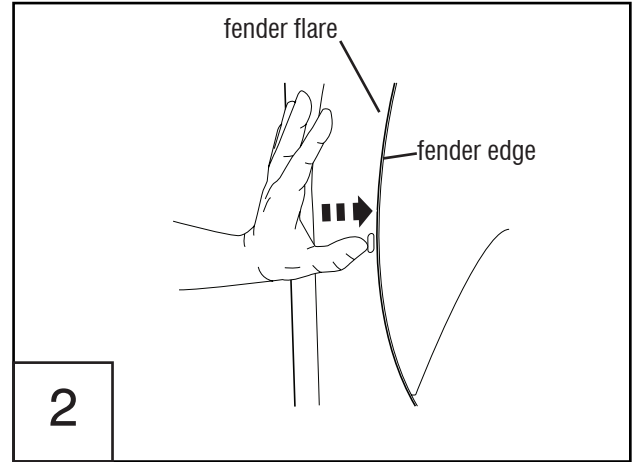

2

Press fender flare edge so that it is flush with fender edge.



3

Press U-clip in place so that it encompasses both edge of fender flare and edge of fender.

Lever Clip Installation

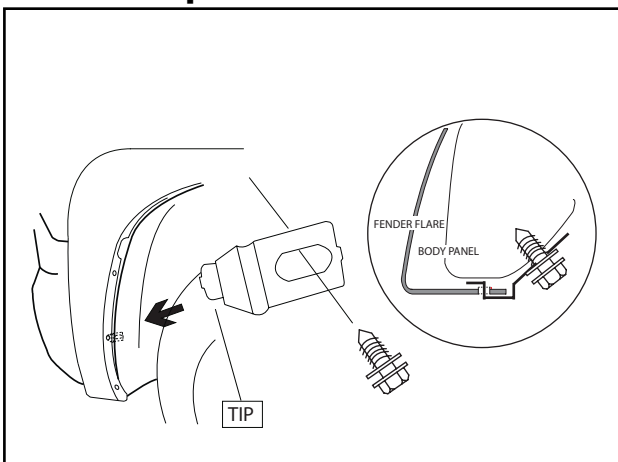

Wrap Black Foam Tab over pencil marks, then install U-Clip on top of it.

Rivet Installation

