



Safety glasses should be worn at all times while installing this product.

YEARS: 2010-CURRENT

MAKE: SUZUKI

MODEL: KIZASHI

STYLE: SEDAN

WARNING: NEVER EXCEED YOUR VEHICLE MANUFACTURER'S RECOMMENDED TOWING CAPACITY

WEIGHT CARRYING:
 TRAILER WEIGHT: 2,000 LBS.
 TONGUE WEIGHT: 200 LBS.

WARNING:
 WE RECOMMEND THE USE OF 18050 STABILIZING STRAPS FOR ALL NON-TRAILER (WHEEL-LESS) LOADS. PLEASE SEE THE CURT CATALOG OR VISIT US ONLINE AT WWW.CURTMFG.COM FOR FURTHER INFORMATION.

INSTALLATION TIME: 45 MIN.

THE INSTALL TIME LISTED IS FOR PROFESSIONAL INSTALLERS. IF YOU ARE HESITANT TO UNDERTAKE THIS TASK ON YOUR OWN, CONTACT AN AUTHORIZED CURT INSTALLER FOR ADDITIONAL ASSISTANCE.

INSTALLATION TIPS:



- BEFORE YOU BEGIN INSTALLATION, READ ALL INSTRUCTIONS THOROUGHLY.
- TO EASE INSTALLATION, 2 PEOPLE MAY BE REQUIRED.
- USING PROPER TOOLS WILL GREATLY IMPROVE THE QUALITY OF THE INSTALL AND REDUCE THE TIME REQUIRED.
- NEED HELP OR HAVE SOME QUESTIONS? CALL TECHNICAL SUPPORT AT 800.798.0813



INSTALLATION REQUIRES:

 TORQUE WRENCH	 RATCHET	 10mm 14mm 3/4" SOCKET
 6" SOCKET EXTENSION	 DIE GRINDER	 SCREW DRIVER
 SPRAY LUBRICANT		

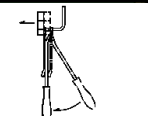
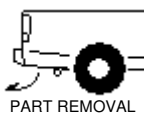
LEVEL OF DIFFICULTY: HARD

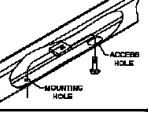
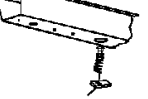
EASY	MODERATE	HARD
	- LOWER EXHAUST	
	- REMOVE HEAT SHIELDS	
	- HOLE ENLARGEMENT REQUIRED	
	- FISHWIRE REQUIRED	
	- REVERSE FISHWIRE REQUIRED	

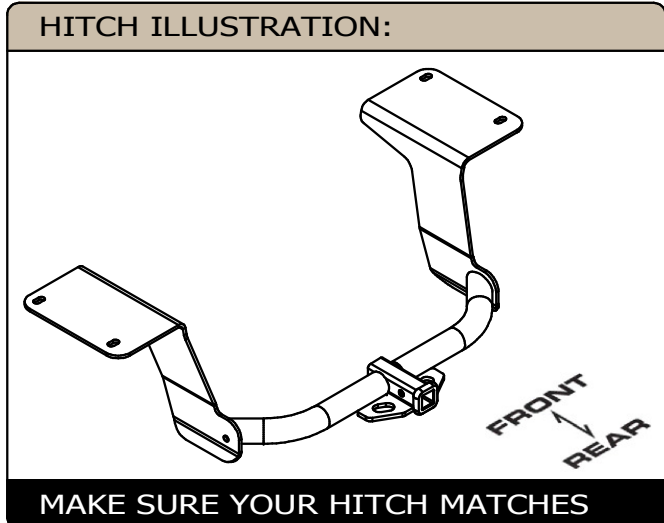

PERIODICALLY CHECK THIS RECEIVER HITCH TO ENSURE ALL FASTENERS ARE TIGHT AND ALL STRUCTURAL COMPONENTS ARE SOUND

CURT Manufacturing Inc. warrants this product to be free of defects in material and/or workmanship at the time of retail purchase by the original purchaser. If the product is found to be defective, Curt Manufacturing Inc. may repair or replace the product at their option, when the product is returned, prepaid, with proof of purchase. Alteration to, misuse of, or improper installation of this product voids the warranty. Curt Manufacturing Inc.'s liability is limited to repair or replacement of products found to be defective, and specifically excludes liability for incidental or consequential loss or damage.

For more information log onto www.curtmfg.com, & for helpful towing tips log onto www.hitchinfo.com

INSTALLATION WALKTHROUGH:

Parts List			
ITEM	QTY	PART NUMBER	DESCRIPTION
1	4	HFN 1213	HEX FLANGE NUT
2	4	CM-SP6	.250 x 1.00 x 3.00" SQUARE HOLE SPACER
3	4	1/2-13 x 1 1/4	CARRIAGE BOLT
4	2	1_2 FISHWIRE	1/2" FISHWIRE

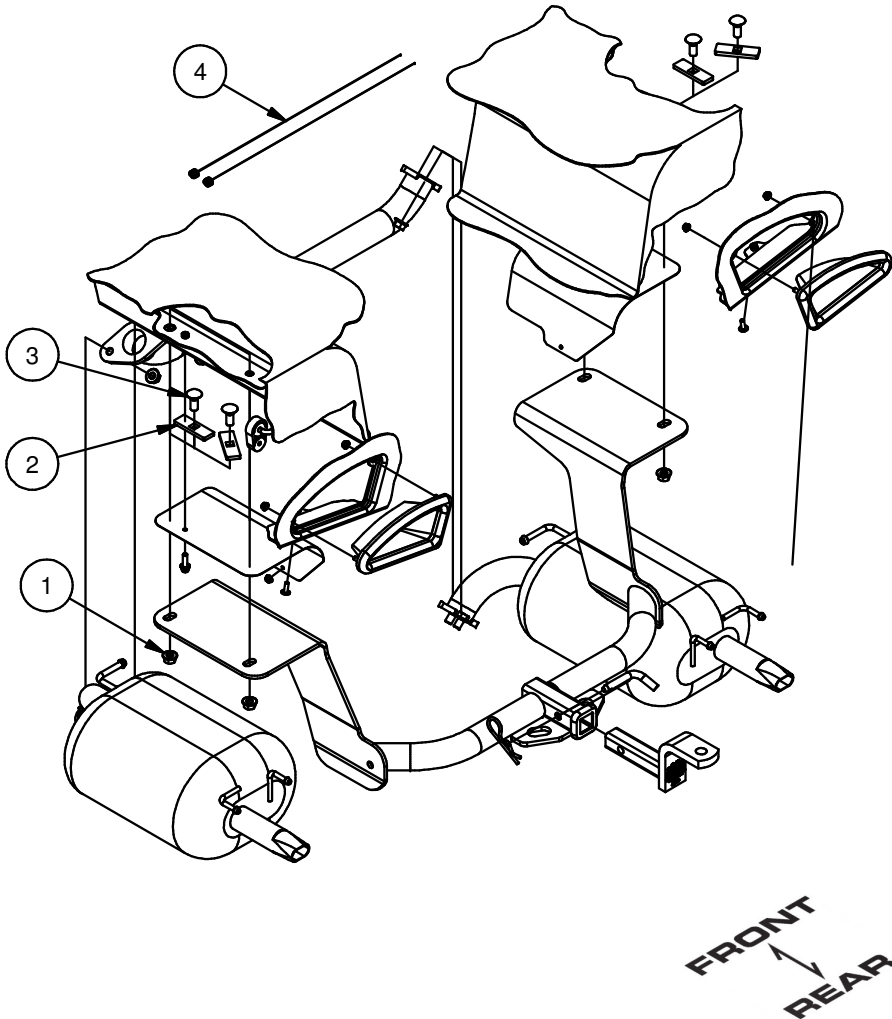

1. Remove exhaust tips from driver and passenger side.



2. Remove rubber isolators from mufflers.

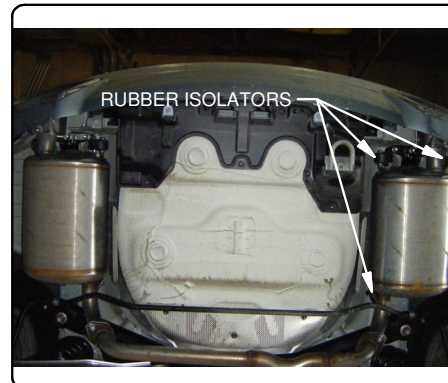

RUBBER ISOLATOR REMOVAL DIAGRAM

This technique can be used if an Exhaust Hanger Removal Pliers is not available.

Using a 5/8" open end wrench, slide the wrench up to the rubber isolator, cradling the hanger rod as shown. Next place the flat edge of a pry bar between the wrench and the hanger stop or hanger rod. Then simply rotate the pry bar toward the wrench to remove the rubber isolator.

Note: Using a spray lubricant or soapy water on the hanger rod and the rubber isolator helps removal.

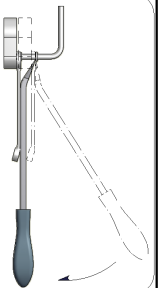

INSTALLATION WALKTHROUGH:

3. Remove fasteners securing mufflers to exhaust pipe and remove mufflers.



4. Remove heat shields from driver and passenger side. Return heat shields and fasteners to owner.



5. Use die grinder to increase the size of the access hole to allow 1/2-13 x 1 1/4" carriage bolts and SP6 spacers to pass through. Use die grinder to increase the rear most hole to allow 1/2-13 carriage bolt to be fishwired through.

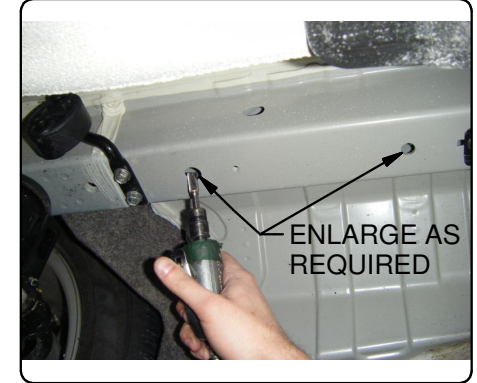

6. Fishwire 1/2-13 x 1 1/4" carriage bolts and SP6 spacers through the enlarged access hole and out the rear-most hole.



FISHWIRE TECHNIQUE

INSERT COILED END OF FISHWIRE TOOL THROUGH HITCH MOUNTING HOLE IN VEHICLE FRAME RAIL AND OUT THE ACCESS HOLE. PASS COILED END OF FISHWIRE THROUGH SPACER AND THREAD BOLT INTO COIL. KINK WIRE TO KEEP SPACER SEPARATE FROM BOLT AS SHOWN. PULL FISHWIRE, SPACER, AND BOLT THROUGH FRAME AND OUT MOUNTING HOLE. USE FISHWIRE TO GUIDE HITCH DURING MOUNTING AND PREVENT LOSS OF BOLT / SPACER INSIDE FRAME RAIL.

MOUNTING HOLE

ACCESS HOLE

NOTE: SOME VEHICLES MAY FISHWIRE THROUGH END OF FRAME

A diagram illustrating the fishwiring technique. It shows a cross-section of a metal frame rail with a mounting hole and an access hole. A fishwire tool is shown inserted through the mounting hole, passing through a spacer and a bolt, and exiting through the access hole. The diagram labels the mounting hole and access hole.

INSTALLATION WALKTHROUGH:

7. Reverse fishwire 1/2-13 x 1 1/4" carriage bolts and SP6 spacers through the enlarged access hole.



REVERSE PULL FISHWIRE TECHNIQUE

ATTACH FISHWIRE TO CARRIAGE BOLT AND SLIDE SPACER ONTO FISHWIRE. PUSH THE BOLT THRU THE HOLE FOLLOWED BY THE SPACER (AS SHOWN). PULL BOLT BACK INTO POSITION, PROTRUDING FROM THE FRAME.

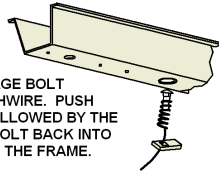

8. Raise hitch into position and secure with 1/2-13 flange nuts. Torque all 1/2" hardware to 110 ft-lbs.

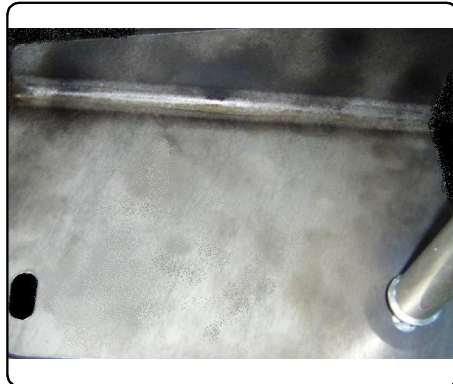

9. Raise mufflers back into position and secure to exhaust pipe. Reattach rubber exhaust hangers. Reinstall exhaust tips.

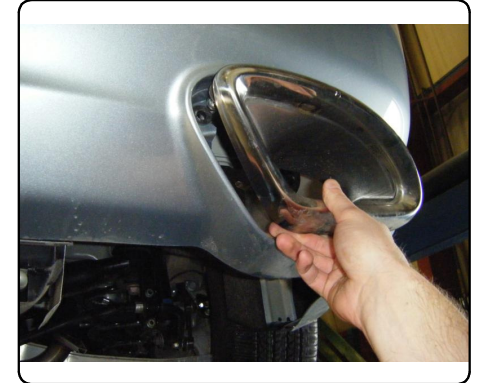

INSTALLATION IS NOW COMPLETE

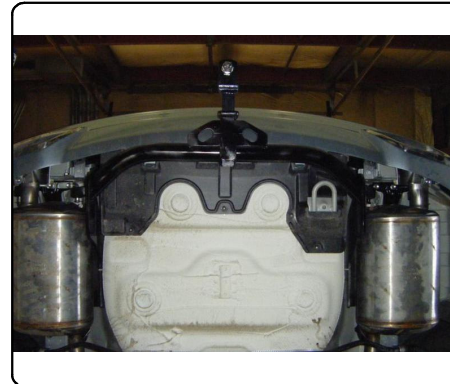

GROSS LOAD CAPACITY WHEN USED AS A WEIGHT CARRYING HITCH: 2,000 LBS. TRAILER WEIGHT & 200 LBS. TONGUE WEIGHT.

DO NOT EXCEED VEHICLE MANUFACTURER'S RECOMMENDED TOWING CAPACITY.

WARNING: ALL NON-TRAILER LOADS APPLIED TO THIS PRODUCT MUST BE SUPPORTED BY 18050 STABILIZING STRAPS.

** FAILURE TO PROPERLY SUPPORT NON-TRAILER LOADS WILL VOID PRODUCT WARRANTY**

HAVING INSTALLATION QUESTIONS? CALL TECHNICAL SUPPORT AT 1-800-798-0813

Parts List			
ITEM	QTY	PART NUMBER	DESCRIPTION
1	4	HFN 1213	HEX FLANGE NUT
2	4	CM-SP6	.250 x 1.00 x 3.00" SQUARE HOLE SPACER
3	4	1/2-13 x 1 1/4	CARRIAGE BOLT
4	2	1_2 FISHWIRE	1/2" FISHWIRE

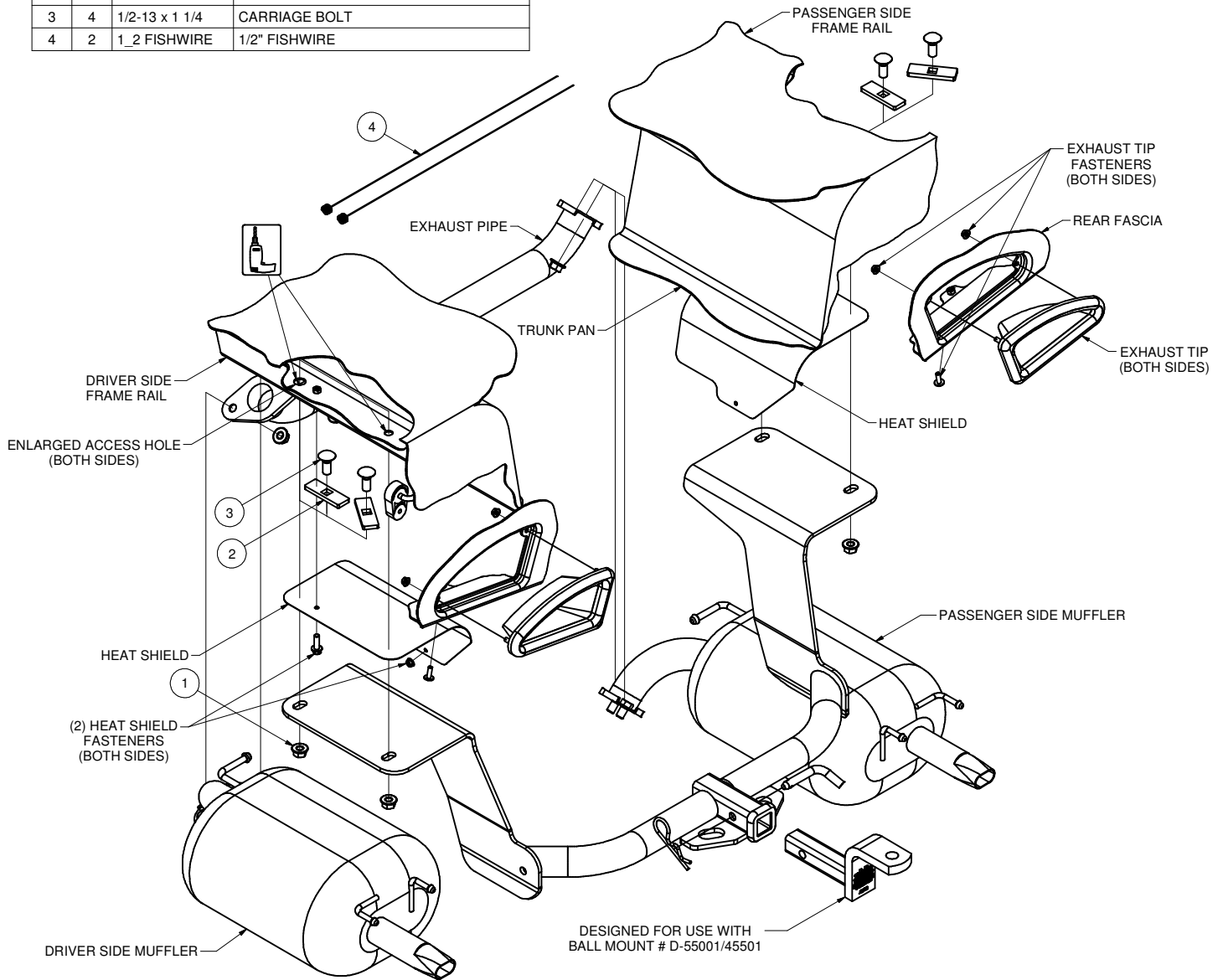

HITCH WEIGHT: .35 LBS.

INSTALL TIME

PROFESSIONAL: 45 MINUTES

NOVICE (DIY): 90 MINUTES

INSTALL NOTES:

- HOLE ENLARGEMENT REQUIRED
- LOWER EXHAUST
- REMOVE HEAT SHIELDS
- FISHWIRE HARDWARE

PERIODICALLY CHECK THIS RECEIVER HITCH TO ENSURE THAT ALL FASTENERS ARE TIGHT AND THAT ALL STRUCTURAL COMPONENTS ARE SOUND.

Curt Manufacturing Inc., warrants this product to be free of defects in material and/or workmanship at the time of retail purchase by the original purchaser. If the product is found to be defective, Curt Manufacturing Inc., may repair or replace the product, at their option, when the product is returned, prepaid, with proof of purchase. Alteration to, misuse of, or improper installation of this product voids the warranty. Curt Manufacturing Inc.'s liability is limited to repair or replacement of products found to be defective, and specifically excludes liability for incidental or consequential loss or damage.

HAVING INSTALLATION QUESTIONS? CALL TECHNICAL SUPPORT AT 1-800-798-0813

RUBBER ISOLATOR REMOVAL DIAGRAM

This technique can be used if and Exhaust Hanger Removal Pliers is not available.

Using a 5/8" open end wrench, slide the wrench up to the rubber isolator, cradling the hanger rod as shown. Next place the flat edge of a pry bar between the wrench and the hanger stop or hanger rod. Then simply rotate the pry bar toward the wrench to remove the rubber isolator.

Note: Using a spray lubricant or soapy water on the hanger rod and the rubber isolator helps removal.

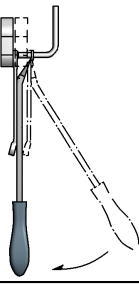

TOOLS REQUIRED

RATCHET
TORQUE WRENCH
6" EXTENSION
PHILLIPS SCREWDRIVER
10mm SOCKET
14mm SOCKET
3/4" SOCKET
DIE GRINDER

REVERSE PULL FISHWIRE TECHNIQUE

ATTACH FISHWIRE TO CARRIAGE BOLT AND SLIDE SPACER ONTO FISHWIRE. PUSH THE BOLT THRU THE HOLE FOLLOWED BY THE SPACER (AS SHOWN). PULL BOLT BACK INTO POSITION, PROTRUDING FROM THE FRAME.

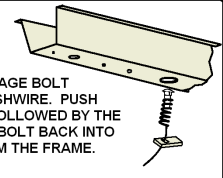

FISHWIRE TECHNIQUE

INSERT COILED END OF FISHWIRE TOOL THROUGH HITCH MOUNTING HOLE IN VEHICLE FRAME RAIL AND OUT THE ACCESS HOLE. PASS COILED END OF FISHWIRE THROUGH SPACER AND THREAD BOLT INTO COIL. KINK WIRE TO KEEP SPACER SEPERATE FROM BOLT AS SHOWN. PULL FISHWIRE, SPACER, AND BOLT THROUGH FRAME AND OUT MOUNTING HOLE. USE FISHWIRE TO GUIDE HITCH DURING MOUNTING AND PREVENT LOSS OF BOLT / SPACER INSIDE FRAME RAIL.

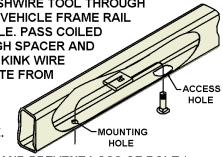

NOTE: SOME VEHICLES MAY FISHWIRE THROUGH END OF FRAME

INSTALLATION STEPS

1. Remove exhaust tips from driver and passenger side.
2. Remove rubber isolators from mufflers. (RUBBER ISOLATOR REMOVAL DIAGRAM)
3. Remove fasteners securing mufflers to exhaust pipe.
4. Remove mufflers from driver and passenger side.
5. Remove heat shields from driver and passenger side and return to owner.
6. Use die grinder to increase the size of the access hole in frame rails to allow 1/2-13 x 1 1/4" carriage bolts and SP6 spacers to pass through.
7. Use die grinder to increase the rear most hole in frame rails to allow 1/2-13 x 1 1/4" carriage bolt to be fishwired through.
8. Fishwire 1/2-13 x 1 1/4" carriage bolts and SP6 spacers through the enlarged access hole and out the rear-most hole, both sides. (SEE FISHWIRE TECHNIQUE)
9. Reverse fishwire 1/2-13 x 1 1/4" carriage bolts and SP6 spacers through the enlarged access hole, both sides. (SEE REVERSE FISHWIRE TECHNIQUE)
10. Raise hitch into position and secure with 1/2-13 flange nuts.
11. Torque all 1/2" hardware to 110 ft-lbs.
12. Raise mufflers back into position and secure to exhaust pipe.
13. Reattach rubber exhaust hangers.
14. Reinstall exhaust tips.

PERIODICALLY CHECK THIS RECEIVER HITCH TO ENSURE THAT ALL FASTENERS ARE TIGHT AND THAT ALL STRUCTURAL COMPONENTS ARE SOUND.