



Safety glasses should be worn at all times while installing this product.

YEARS: 2011-PRESENT

MAKE: VOLVO

MODEL: C30

STYLE: HATCHBACK

WARNING: NEVER EXCEED YOUR VEHICLE MANUFACTURER'S RECOMMENDED TOWING CAPACITY
 For more information log onto www.curtmfg.com & for helpful towing tips log onto www.hitchinfo.com

WEIGHT CARRYING:
 TRAILER WEIGHT: 2,000 LBS.
 TONGUE WEIGHT: 200 LBS.

WARNING:
 ALL NON-TRAILER (WHEEL-LESS) LOADS APPLIED TO THIS PRODUCT MUST BE SUPPORTED BY 18050 STABILIZING STRAPS. PLEASE SEE THE CURT CATALOG OR VISIT US ONLINE AT WWW.CURTMFG.COM FOR FURTHER INFORMATION.

PRO INSTALL TIME: 20 MIN.
NOVICE INSTALL TIME: 40 MIN.

IF YOU ARE HESITANT TO UNDERTAKE THIS TASK ON YOUR OWN, CONTACT AN AUTHORIZED CURT INSTALLER FOR ADDITIONAL ASSISTANCE.

INSTALLATION REQUIRES:

SAFETY GLASSES	T-25 TORXBIT SOCKET	RATCHET
3/4" SOCKET	6" SOCKET EXTENSION	TAPE MEASURE
MARKER	AVIATION SHEARS	TORQUE WRENCH

INSTALLATION TIPS:

- BEFORE YOU BEGIN INSTALLATION, READ ALL INSTRUCTIONS THOROUGHLY.
- TO EASE INSTALLATION, 2 PEOPLE MAY BE REQUIRED.
- USING PROPER TOOLS WILL GREATLY IMPROVE THE QUALITY OF THE INSTALL AND REDUCE THE TIME REQUIRED.
- NEED HELP OR HAVE SOME QUESTIONS? CALL TECHNICAL SUPPORT AT 877.287.8634

LEVEL OF DIFFICULTY: MODERATE

EASY	MODERATE	CHALLENGING
	TEMPORARILY REMOVE PLASTIC FASCIA	
	FISHWIRING REQUIRED	
	TRIM HEAT SHEILD AND PLASTIC FASCIA	
	NO DRILLING REQUIRED	

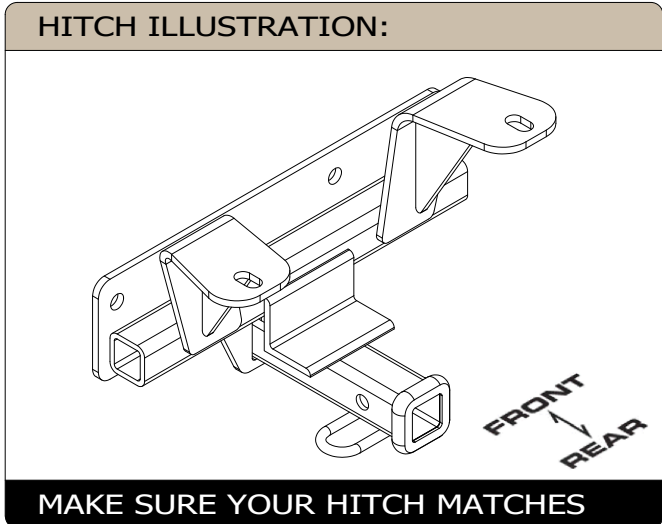
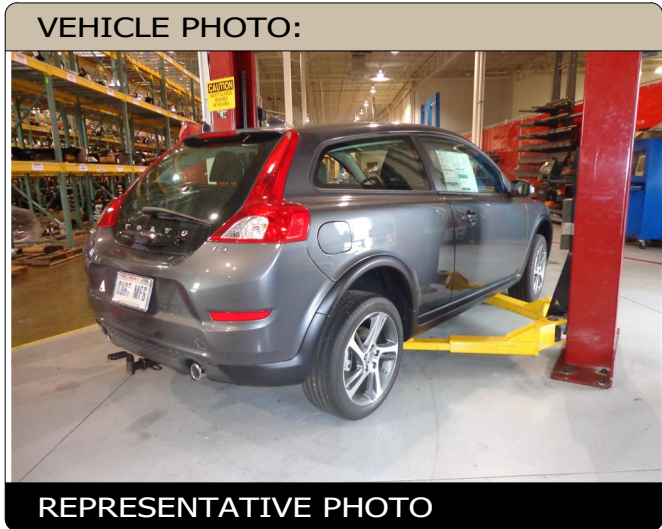

PERIODICALLY CHECK THIS RECEIVER HITCH TO ENSURE ALL FASTENERS ARE TIGHT AND ALL STRUCTURAL COMPONENTS ARE SOUND

CURT Manufacturing LLC. warrants this product to be free of defects in material and/or workmanship at the time of retail purchase by the original purchaser. If the product is found to be defective, CURT Manufacturing LLC. may repair or replace the product at their option, when the product is returned, prepaid, with proof of purchase. Alteration to, misuse of, or improper installation of this product voids the warranty. CURT Manufacturing LLC.'s liability is limited to repair or replacement of products found to be defective, and specifically excludes liability for incidental or consequential loss or damage.

For more information log onto www.curtmfg.com

This product complies with safety specifications and requirements for connecting devices and towing systems of the state of New York, V.E.S.C.Regulation V-5 and SAE J684.

SCAN FOR MORE INFO

INSTALLATION WALKTHROUGH:

Parts List			
ITEM	QTY	PART NUMBER	DESCRIPTION
1	4	30-00149	WASHER,S-CON,1/2,YZ
2	4	10-10035	HHCS,1/2-13 UNC,1-1/2,GRD5
3	2	20-00062	NUT, SER-FLANGE,1/2-13 UNC,GRD8,YZ
4	2	10-10287	BOLT,CAR,1/2-13 UNC,1-1/2,GRD8,YZ
5	2	CM-SP6	.250 x 1.00 x 3.00" SPACER
6	2	1_2 FISHWIRE	1/2" FISHWIRE
7	1	11337-MPWA	MOUNTING PLATE WELDMENT

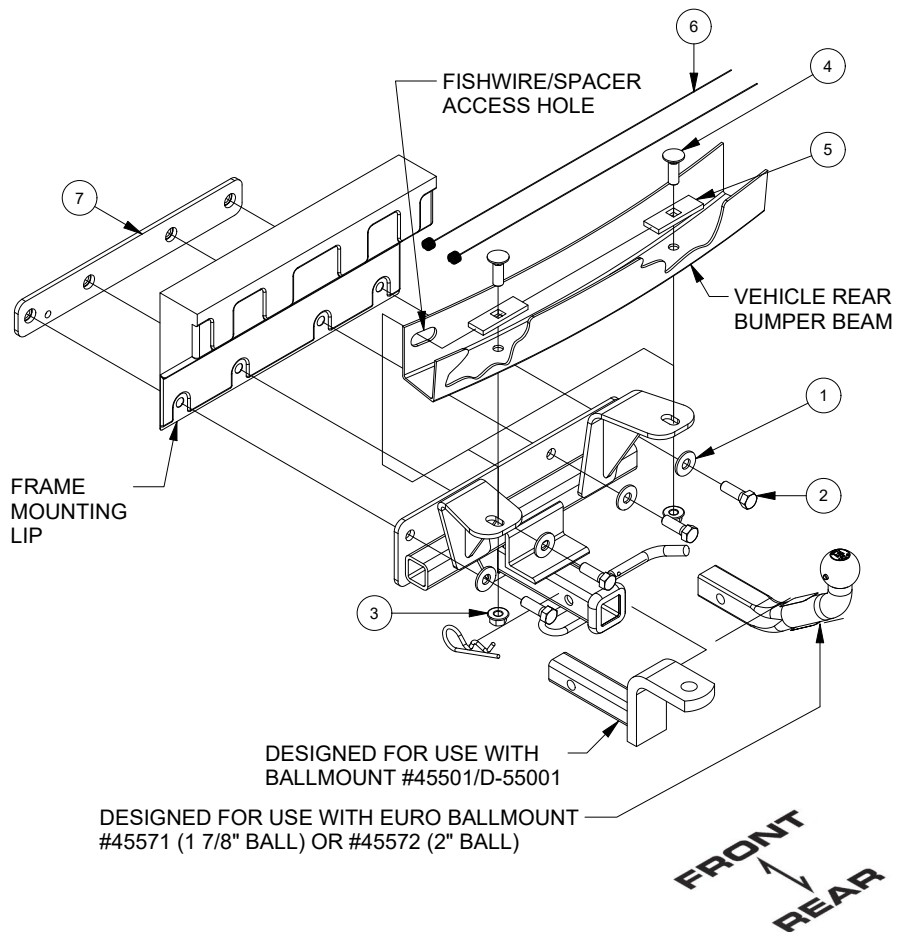

1. Remove plastic fascia from rear of vehicle to gain access to hitch mounting locations. First, remove (2) screws from plastic mounting brackets using a T-25 Torxbit socket. Then, un-clip plastic from vehicle and gently pull back to remove.

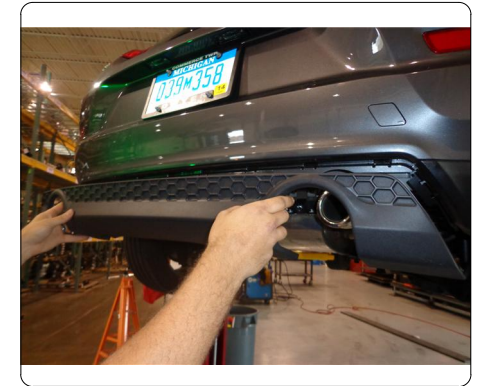
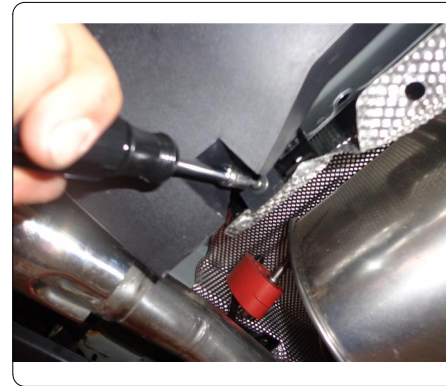

2. Fishwire (2) 1/2" carriage bolts and spacer blocks through driver side access hole in bumper beam.

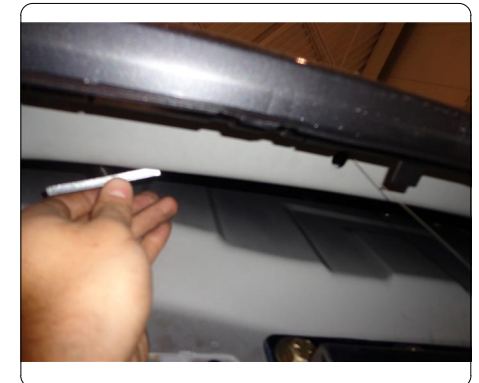

INSTALLATION WALKTHROUGH:

- Slide mounting plate assembly up behind the frame mounting lip. Ensure the plate is sitting flush on the back of the mounting surface with the weld nuts pointing toward the front of the vehicle.



- Raise hitch into position, securing to 1/2" fishwired hardware and to the 1/2" weldnuts in the mounting plate.

Torque 1/2" hex head bolts to 75 lb-ft. Torque 1/2" carriage bolts to 110 lb-ft.

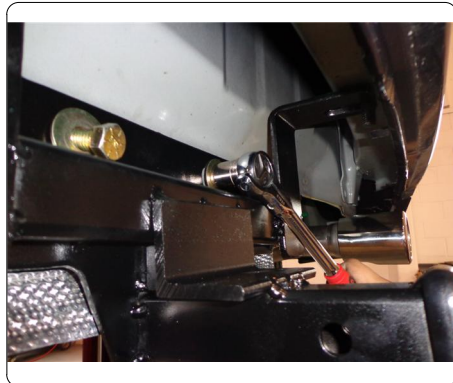
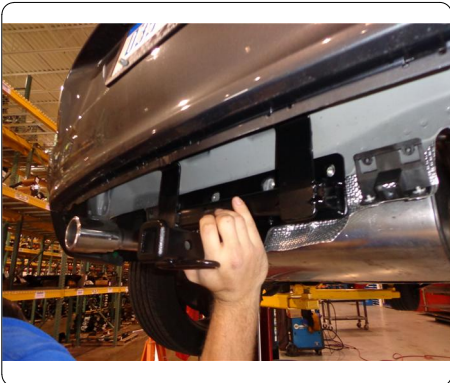

- Mark and trim both heat shield and plastic rear fascia as shown. Bend heat shield up into its concealed position. Reattach plastic fascia by clipping back onto vehicle and securing both screws on sides of vehicle.

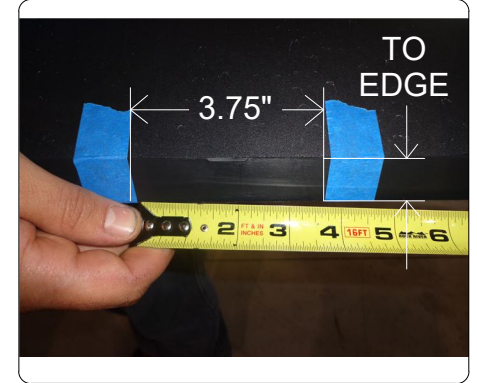
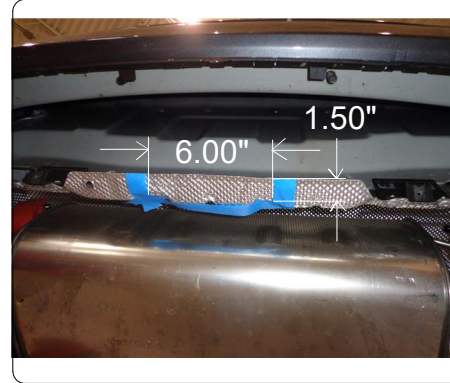

Installation is complete

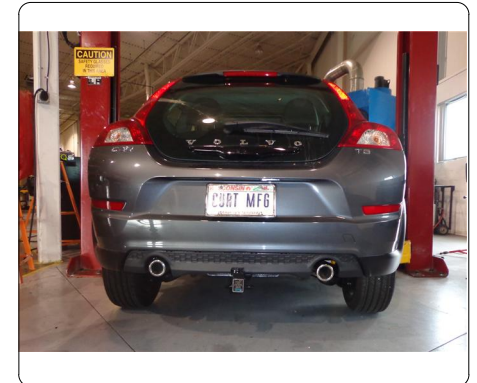
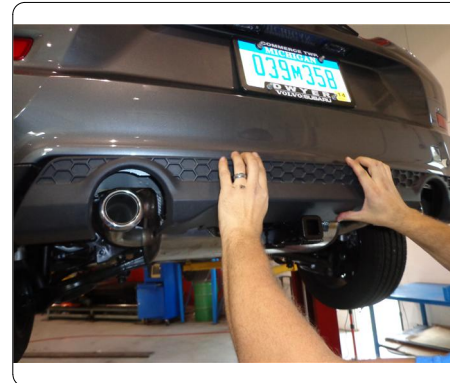

11337

VOLVO C30

4/20/2021

GROSS LOAD CAPACITY WHEN USED AS A WEIGHT CARRYING HITCH: 2,000 LBS. TRAILER WEIGHT & 200 LBS. TONGUE WEIGHT.

*****DO NOT EXCEED VEHICLE MANUFACTURER'S RECOMMENDED TOWING CAPACITY.*****

WARNING: ALL NON-TRAILER LOADS APPLIED TO THIS PRODUCT MUST BE SUPPORTED BY 18050 STABILIZING STRAPS.

**** FAILURE TO PROPERLY SUPPORT NON-TRAILER LOADS WILL VOID PRODUCT WARRANTY****

HAVING INSTALLATION QUESTIONS? CALL TECHNICAL SUPPORT AT 877-287-8634

Parts List			
ITEM	QTY	PART NUMBER	DESCRIPTION
1	4	30-00149	WASHER, S-CON, 1/2, YZ
2	4	10-10035	HHCS, 1/2-13 UNC, 1-1/2, GRD5
3	2	20-00062	NUT, SER-FLANGE, 1/2-13 UNC, GRD8, YZ
4	2	10-10287	BOLT, CAR, 1/2-13 UNC, 1-1/2, GRD8, YZ
5	2	CM-SP6	.250 x 1.00 x 3.00" SQUARE HOLE SPACER
6	2	1_2 FISHWIRE	1/2" FISHWIRE
7	1	11337-MPWA	MOUNTING PLATE WELDMENT ASSEMBLY

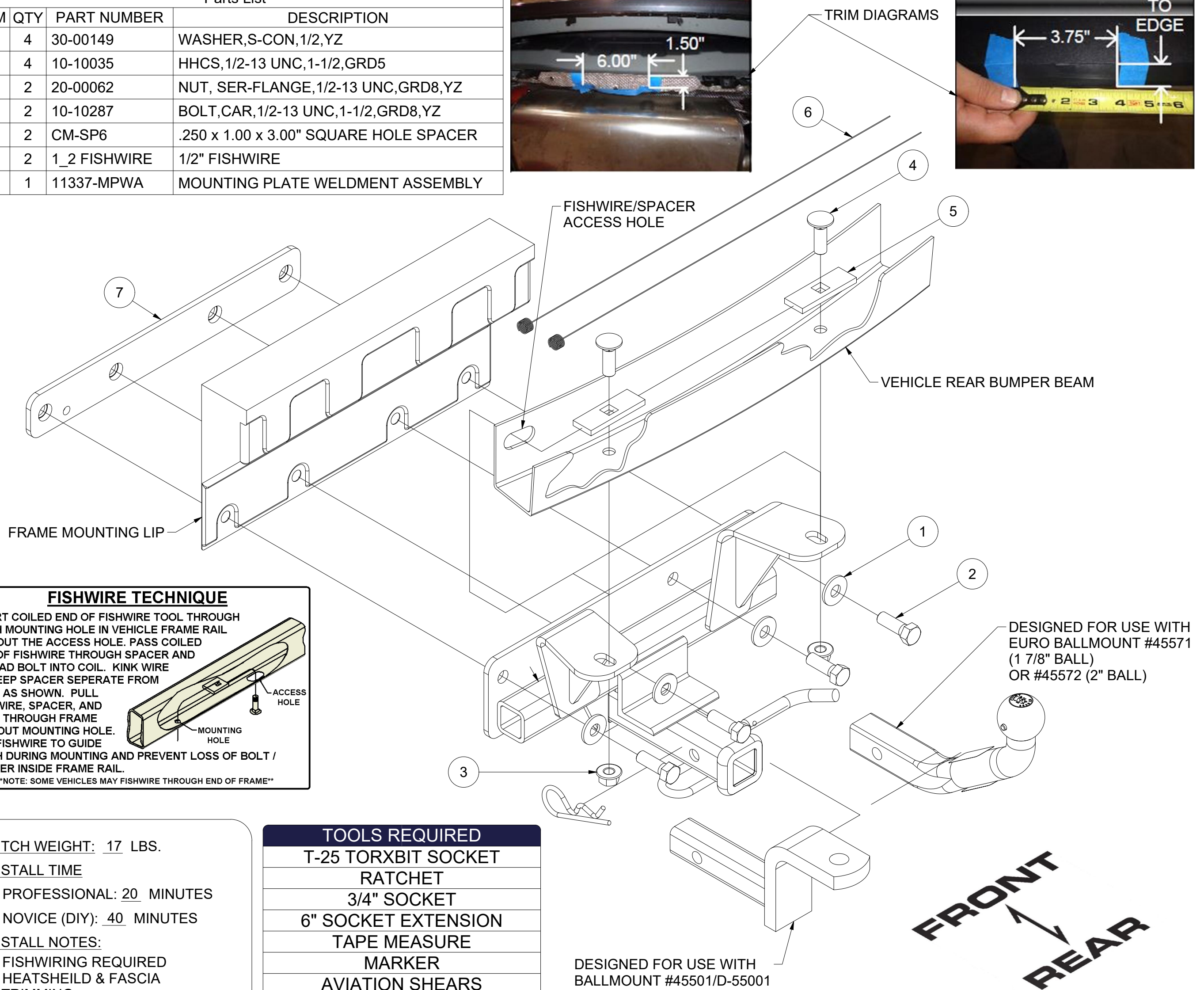
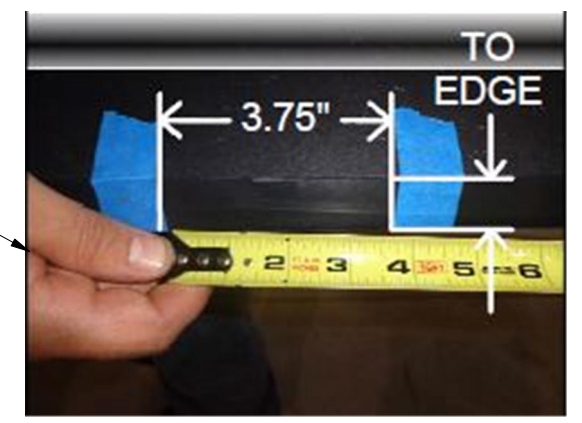
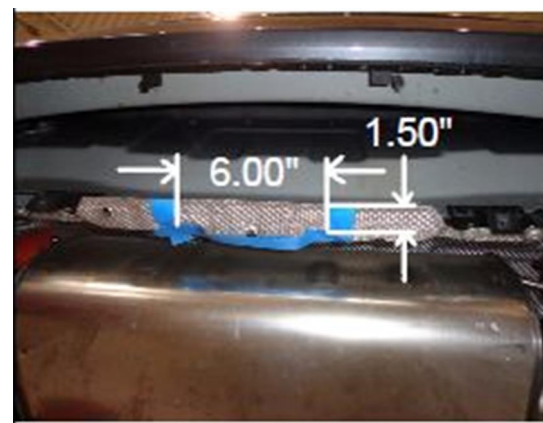

FISHWIRE TECHNIQUE

INSERT COILED END OF FISHWIRE TOOL THROUGH HITCH MOUNTING HOLE IN VEHICLE FRAME RAIL AND OUT THE ACCESS HOLE. PASS COILED END OF FISHWIRE THROUGH SPACER AND THREAD BOLT INTO COIL. KINK WIRE TO KEEP SPACER SEPERATE FROM BOLT AS SHOWN. PULL FISHWIRE, SPACER, AND BOLT THROUGH FRAME AND OUT MOUNTING HOLE. USE FISHWIRE TO GUIDE HITCH DURING MOUNTING AND PREVENT LOSS OF BOLT / SPACER INSIDE FRAME RAIL.

NOTE: SOME VEHICLES MAY FISHWIRE THROUGH END OF FRAME

HITCH WEIGHT: 17 LBS.

INSTALL TIME

PROFESSIONAL: 20 MINUTES

NOVICE (DIY): 40 MINUTES

INSTALL NOTES:

- FISHWIRING REQUIRED
- HEATSHEILD & FASCIA TRIMMING
- NO DRILLING REQUIRED

TOOLS REQUIRED
T-25 TORXBIT SOCKET
RATCHET
3/4" SOCKET
6" SOCKET EXTENSION
TAPE MEASURE
MARKER
AVIATION SHEARS
TORQUE WRENCH

INSTALLATION STEPS

1. Remove plastic fascia from rear of vehicle to gain access to hitch mounting locations. First, remove (2) screws from plastic mounting brackets using a T-25 Torxbit socket. Then, un-clip plastic from vehicle and gently pull back to remove.
2. Fishwire (2) 1/2" carriage bolts and spacer blocks through driver side access hole in bumper beam.
3. Slide mounting plate assembly up behind the frame mounting lip. Ensure the plate is sitting flush on the back of the mounting surface with the weld nuts pointing toward the front of the vehicle.
4. Raise hitch into position, securing to 1/2" fishwired hardware and to the 1/2" weldnuts in the mounting plate. Torque 1/2" hex head bolts to 75 lb-ft. Torque 1/2" carriage bolts to 110 lb-ft.
5. Mark and trim both heat sheild and plastic rear fascia as needed. Bend heat shield up into its concealed position. Reattach plastic fascia by clipping back onto vehicle and securing both screws on sides of vehicle.

PERIODICALLY CHECK THIS RECEIVER HITCH TO ENSURE THAT ALL FASTENERS ARE TIGHT AND THAT ALL STRUCTURAL COMPONENTS ARE SOUND.

Curt Manufacturing LLC., warrants this product to be free of defects in material and/or workmanship at the time of retail purchase by the original purchaser. If the product is found to be defective, Curt Manufacturing LLC., may repair or replace the product, at their option, when the product is returned, prepaid, with proof of purchase. Alteration to, misuse of, or improper installation of this product voids the warranty. Curt Manufacturing LLC.'s liability is limited to repair or replacement of products found to be defective, and specifically excludes liability for incidental or consequential loss or damage.