

11811 93-98 SAAB 9000 HATCHBACK (INCL. AERO & TURBO), 89-95 SEDAN CD (INCL. TURBO)

11/13/2017

GROSS LOAD CAPACITY WHEN USED AS A WEIGHT CARRYING HITCH: 2,000 LBS. TRAILER WEIGHT & 200 LBS. TONGUE WEIGHT.

*****DO NOT EXCEED VEHICLE MANUFACTURER'S RECOMMENDED TOWING CAPACITY.*****

WARNING: ALL NON-TRAILER LOADS APPLIED TO THIS PRODUCT MUST BE SUPPORTED BY 18050 STABILIZING STRAPS.

**** FAILURE TO PROPERLY SUPPORT NON-TRAILER LOADS WILL VOID PRODUCT WARRANTY****

HAVING INSTALLATION QUESTIONS? CALL TECHNICAL SUPPORT AT 1-800-798-0813

Parts List			
ITEM	QTY	PART NUMBER	DESCRIPTION
1	5	M10 - 1.5 x 30 HEX	HEX TAP BOLT
2	5	7/16 LOCK WASHER	HELICAL LOCK WASHER

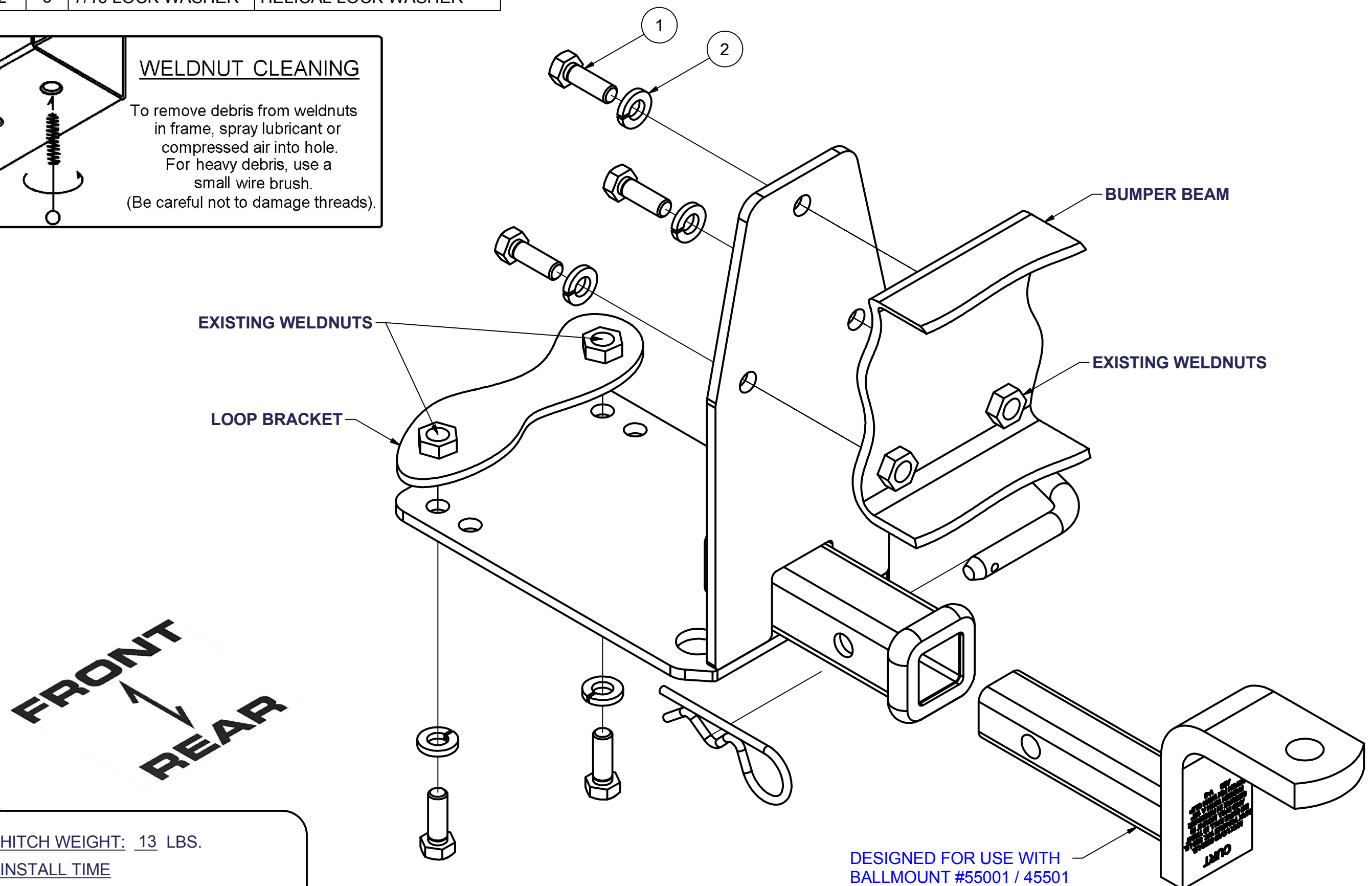
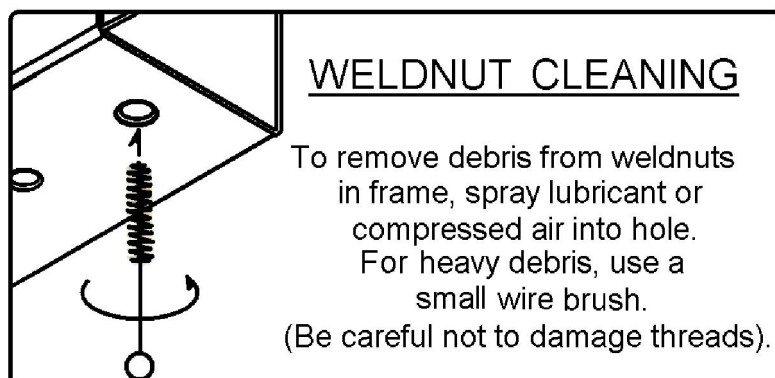

HITCH WEIGHT: 13 LBS.

INSTALL TIME

PROFESSIONAL: 10 MINUTES

NOVICE (DIY): 20 MINUTES

INSTALL NOTES:

- REMOVE TOW LOOP
- NO DRILLING REQUIRED
- MAY REQUIRE BUMPER REMOVAL

INSTALLATION STEPS

NOTE: Some models require bumper removal to install fasteners.

1. Remove the existing tow loop located under center rear of vehicle. Remove the rear bumper if necessary. Fasteners are located inside the trunk at either side against the rear wall. One fastener per side is located under a plastic floor plug. Remove small screws joining bumper fascia near rear wheel wells.
2. The hitch mounting plate will fasten to the bumper beam three places. Remove any existing bolts in these holes. Mount the hitch receiver to bumper using fasteners as shown.
3. Reinstall rear bumper, if removed. Align hitch chassis bracket with tow loop bracket under center of vehicle floor by adjusting bumper position to align holes. Install remaining fasteners as shown.
4. Torque all hardware to 70 lb.-ft.

PERIODICALLY CHECK THIS RECEIVER HITCH TO ENSURE THAT ALL FASTENERS ARE TIGHT AND THAT ALL STRUCTURAL COMPONENTS ARE SOUND.

Curt Manufacturing Inc., warrants this product to be free of defects in material and/or workmanship at the time of retail purchase by the original purchaser. If the product is found to be defective, Curt Manufacturing Inc., may repair or replace the product, at their option, when the product is returned, prepaid, with proof of purchase. Alteration to, misuse of, or improper installation of this product voids the warranty. Curt Manufacturing Inc.'s liability is limited to repair or replacement of products found to be defective, and specifically excludes liability for incidental or consequential loss or damage.