

YEARS: 2013 ~

MAKE: MAZDA

MODEL: CX-5

STYLE: CROSSOVER

**WARNING: NEVER EXCEED YOUR VEHICLE MANUFACTURER'S RECOMMENDED TOWING CAPACITY**  
 For more information log onto [www.curtmfg.com](http://www.curtmfg.com) & for helpful towing tips log onto [www.hitchinfo.com](http://www.hitchinfo.com)

**WEIGHT CARRYING:**  
 TRAILER WEIGHT: 3,500 LBS.  
 TONGUE WEIGHT: 350 LBS.

**PRO INSTALL TIME: 20 MIN.**  
**NOVICE INSTALL TIME: 40 MIN.**

IF YOU ARE HESITANT TO UNDERTAKE THIS TASK ON YOUR OWN, CONTACT AN AUTHORIZED CURT INSTALLER FOR ADDITIONAL ASSISTANCE.



**INSTALLATION REQUIRES:**

 <b>3/4" &amp; 19mm</b>		 <b>MASKING TAPE</b>
<b>SOCKET</b>	<b>RATCHET</b>	
		
<b>FLATHEAD SCREW DRIVER</b>	<b>PLIERS</b>	<b>PRY BAR</b>
		
<b>TORQUE WRENCH</b>	<b>SAFETY GLASSES</b>	

**INSTALLATION TIPS:**

- BEFORE YOU BEGIN INSTALLATION, READ ALL INSTRUCTIONS THOROUGHLY.
- TO EASE INSTALLATION, 2 PEOPLE MAY BE REQUIRED.
- USING PROPER TOOLS WILL GREATLY IMPROVE THE QUALITY OF THE INSTALL AND REDUCE THE TIME REQUIRED.
- NEED HELP OR HAVE SOME QUESTIONS? CALL TECHNICAL SUPPORT AT 877.287.8634

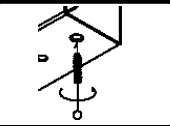
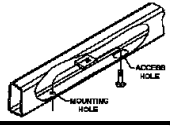
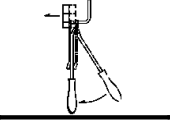
**LEVEL OF DIFFICULTY: EASY**

EASY	MODERATE	CHALLENGING
	REMOVE PLASTIC PANEL	
	MAY REQUIRE WELD NUT CLEANING	
	FISHWIRE HARDWARE	
	TEMPORARILY LOWER EXHAUST	
	NO DRILLING REQUIRED	

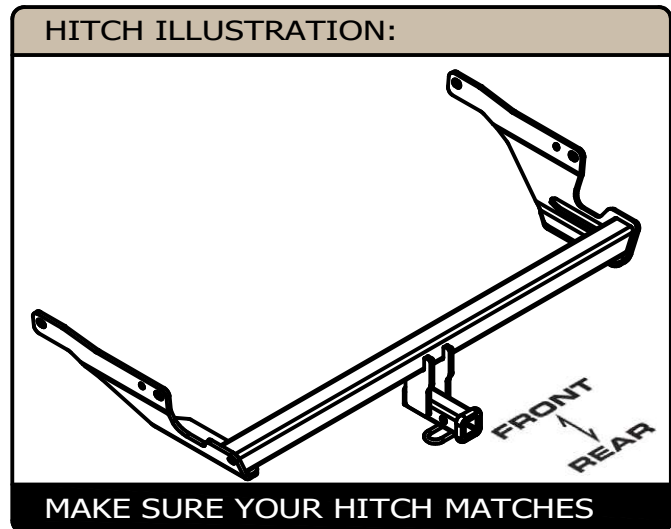

**PERIODICALLY CHECK THIS RECEIVER HITCH TO ENSURE ALL FASTENERS ARE TIGHT AND ALL STRUCTURAL COMPONENTS ARE SOUND**  
 CURT Manufacturing LLC. warrants this product to be free of defects in material and/or workmanship at the time of retail purchase by the original purchaser. If the product is found to be defective, CURT Manufacturing LLC. may repair or replace the product at their option, when the product is returned, prepaid, with proof of purchase. Alteration to, misuse of, or improper installation of this product voids the warranty. CURT Manufacturing LLC.'s liability is limited to repair or replacement of products found to be defective, and specifically excludes liability for incidental or consequential loss or damage.  
 For more information log onto [www.curtmfg.com](http://www.curtmfg.com)  
 This product complies with safety specifications and requirements for connecting devices and towing systems of the state of New York, V.E.S.C.Regulation V-5 and SAE J684.

# INSTALLATION WALKTHROUGH:

Parts List			
ITEM	QTY	PART NUMBER	DESCRIPTION
1	3	10-10277	HHCS,M12x1.25,40CL10.9,YZ
2	2	10-10287	BOLT,CAR,1/2-13 UNC,1-1/2,GRD8,YZ
3	2	20-00062	NUT,SER-FLANGE,1/2-13 UNC,GRD8,YZ
4	3	30-00149	WASHER,S-CON,1/2,YZ
5	4	30-00133	WASHER,FLAT,1/2,YZ
6	2	CM-SP12	.250 x 1.00 x 2.00" SQUARE HOLE SPACER
7	2	1_2_FISHWIRE	1/2" FISHWIRE
8	2	600043	CABLE TIE 3/16 X 8" 50# UV BLACK

**FISHWIRE TECHNIQUE**

INSERT COILED END OF FISHWIRE TOOL THROUGH HITCH MOUNTING HOLE IN VEHICLE FRAME RAIL AND OUT THE ACCESS HOLE. PASS COILED END OF FISHWIRE THROUGH SPACER AND THREAD BOLT INTO COIL. KINK WIRE TO KEEP SPACER SEPARATE FROM BOLT AS SHOWN. PULL FISHWIRE, SPACER, AND BOLT THROUGH FRAME AND OUT MOUNTING HOLE. USE FISHWIRE TO GUIDE HITCH DURING MOUNTING AND PREVENT LOSS OF BOLT / SPACER INSIDE FRAME RAIL.

\*\*NOTE: SOME VEHICLES MAY FISHWIRE THROUGH END OF FRAME\*\*

**WELDNUT CLEANING**

To remove debris from weldnuts in frame, spray lubricant or compressed air into hole. For heavy debris, use a small wire brush. (Be careful not to damage threads).

1. Remove plastic underbody panel under rear bumper (if present) by removing two plastic fasteners with a flat head screwdriver. Return panel & fasteners to vehicle owner.



2. Remove tape on the side of vehicle frame rails to expose mounting locations. Trim any excess seam seal (if it will interfere with hitch).

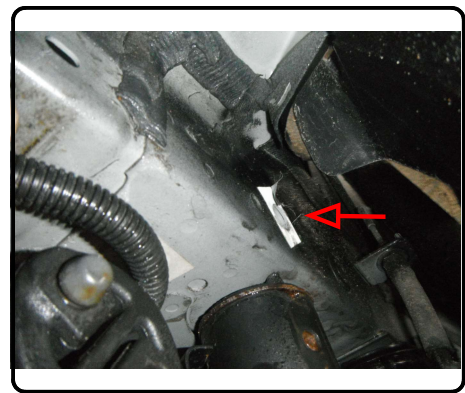
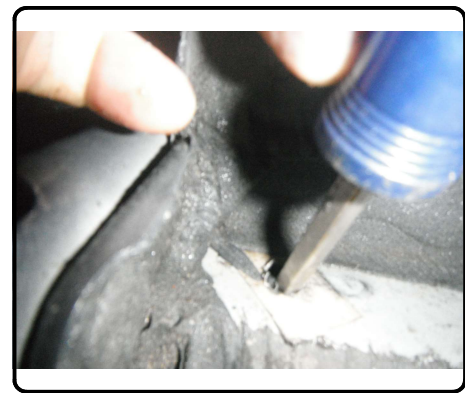

## INSTALLATION WALKTHROUGH:

3. Remove plastic insert (if present) &/or electrical harness clip between hitch mounting locations on passenger side frame rail. Unfasten electrical harness clip on outside of the driver side frame rail & follow harness to unfasten nearest clip towards center of vehicle.

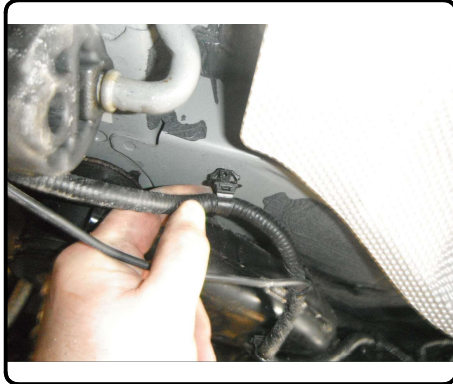
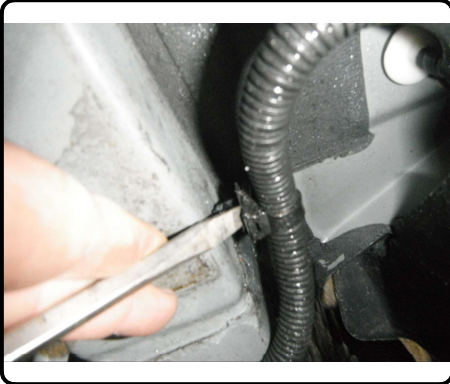

4. Lower exhaust by removing two to four (depending on vehicle) rearmost rubber hangers. Leave rubber hangers attached to the vehicle.

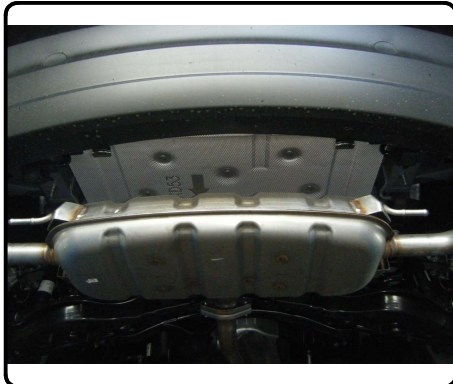
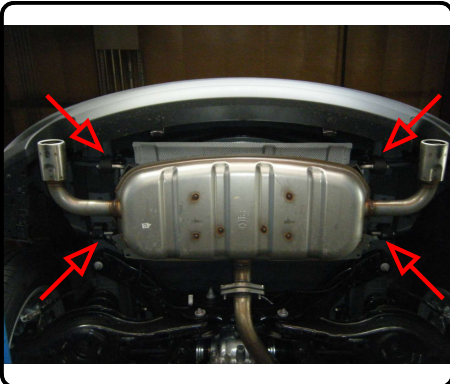

For more information log onto [www.curtmfg.com](http://www.curtmfg.com)

5. To ease installation tape four 1/2" flat washers into position on the inside of hitch side plates.



6. Fishwire 1/2" carriage bolt with CM-SP12 spacer in through access hole and out rearmost mounting location in the passenger frame rail. Repeat on rearmost mounting location in driver side frame rail (if there is no weldnut in frame). Leave hardware fully inside of frame rail(s) with fishwire(s) attached. See FISHWIRE TECHNIQUE diagram on page 2.



## INSTALLATION WALKTHROUGH:

7. Thread fishwire(s) through rearmost hitch mounting holes. Pull bumper fascia rearward and exhaust downward to get hitch into position.

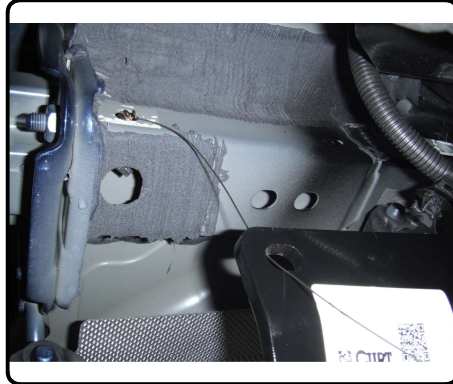

8. Insert M12 bolts with conical toothed washers. Be sure the tooth side of washers are against the hitch and the 1/2" flat washers clamped in position between the hitch and frame rail.

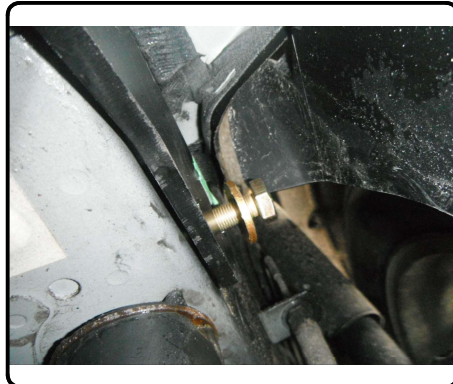
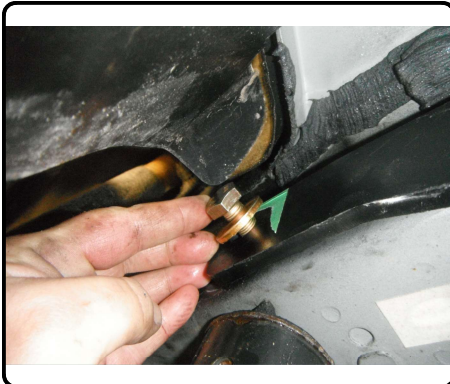

9. Pull 1/2" hardware into position & remove fishwire(s). Fasten with 1/2" hex flange nut(s). Re-secure harness which was unfastened in step 3. Wrap cable tie(s) around hitch mounting plate(s) and harness. Pull tight & trim excess cable tie.

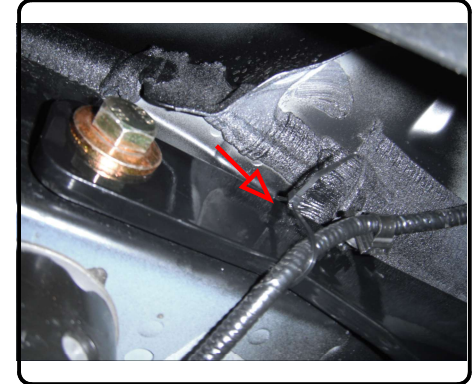
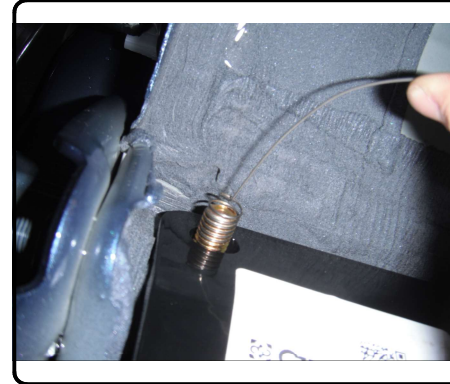

10. Torque all M12 hardware to 86.2 ft-lbs & 1/2" hardware to 110 ft-lbs.

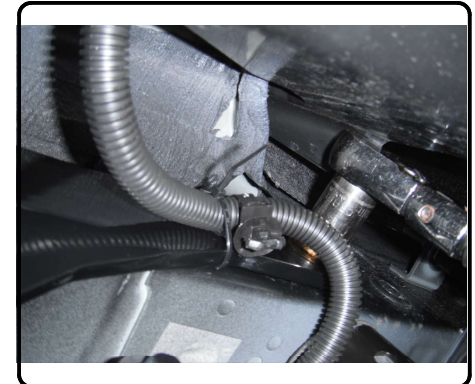
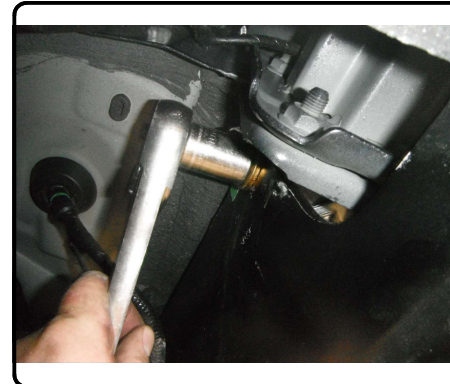

## TOWING SAFETY INFORMATION

### Gross Trailer Weight / GTW

The Gross Trailer Weight is the weight of the trailer & cargo. Measure this by putting the fully loaded trailer on a vehicle scale.

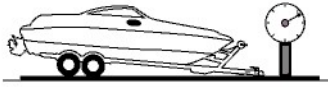

### Tongue Weight / TW

The downward force that is exerted on the hitch ball by the coupler. The tongue weight will vary depending on where the load is positioned in relationship to the trailer axle(s). To measure the tongue weight, use either a commercial scale or a bathroom scale with the coupler at towing height. When using a bathroom scale with heavier tongue weights, use the method shown and multiply the scale reading by 3.

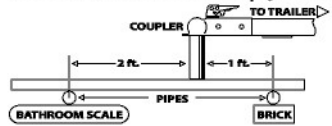

### Weight Carrying / WC

The total weight of both the trailer and the cargo inside. Never exceed the weight capacity of your trailer hitch.

### Weight Distribution / WD

Used to balance the weight of the cargo between the front and rear wheels throughout the trailer, allowing for better steering, braking, and level riding.



### Sway Control

A device used to reduce the lateral movements of the trailer that are caused by the wind. This works in conjunction with a weight distribution hitch. Do not use this on a class 1 or 2 hitch, or with surge brakes.

### How Much Can You Safely Tow?

TONGUE WEIGHT (lb)	1000	2000	3000	4000	5000	6000	7000	8000	10,000	12,000
Tongue weight should be about 10 to 15 percent of the gross trailer weight.										
CLASS 1										
CLASS 2										
CLASS 3										
CLASS 4										
CLASS 5										
TRAILER TYPE										
Camper	11'	12'	13'	14'	15'	16'				
lbs.	1100	1200	1300	1400	1500	1600				
Vacation	18'	19'	20'	22'	24'	26'	28'	30'	32'	
lbs.	2100	2400	2700	3000	3300	3600	3900	4200	4500	4800
Vacation	18'	19'	20'	22'	24'	26'	28'	30'	32'	
lbs.	2800	3200	3600	4000	4400	4800	5200	5600	6000	6400
5th Wheel										

**Refer to owner's manual for towing capabilities and limitations.**

### Ball Mount

The ball mount is placed inside the opening of the receiver hitch which is mounted to the vehicle. Make sure a hitch pin and clip is properly securing the ball mount to the receiver hitch before you begin towing.

- A: Rise. B: Drop. C: Hole Size. D: Length.

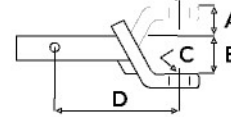

### Trailer Ball

The connection from the hitch to the trailer. There are many factors that determine the correct hitch ball:

- Number one is the hitch ball's gross trailer weight rating.
- The mounting platform must be at least 3/8" thick.
- The hole diameter must not be more than 1/16" larger than the threaded shank.
- Every time you tow, check the nut and lock washer to make sure they are fastened securely.
- A: Ball Dia. B: Shank Length. C: Shank Dia. D: Shank Rise.

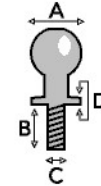

### Coupler

The component that is placed over the trailer ball to connect the vehicle to the trailer. Be sure that the coupler size matches the size of the hitch ball and that the coupler handle is securely fastened. To determine what size hitch ball you need for your application you will need to know the size of coupler that is on the trailer. Be sure your coupler is properly adjusted to the ball you are using.

NOTE: For added security the use of safety devices such as Coupler Safety Pins and Locks is strongly recommended.

### Safety Chains

Safety chains are a requirement and should be crossed under the tongue of the trailer so that the tongue will not drop to the road if it becomes separated from the hitch. Always leave enough slack so you can turn. Never allow the safety chains to drag on the ground and never attach the chains to the bumper.

Trailer Classification: Safety Chain Breaking Force - Minimum

Class 1: 2,000 lbs. (8.9 kN)

Class 2: 3,500 lbs. (15.6 kN)

Class 3: 5,000 lbs. (22.2 kN)

The strength rating of each length of safety chain or its equivalent and its attachments shall be equal to or exceed in minimum breaking force the GVWR (Gross Vehicle Weight Rating) of the trailer.

### Electrical

Trailer lights, Electric Brakes, Break-away systems - Every time you tow, be sure to check that all components are working properly.

Wiring identification by color:

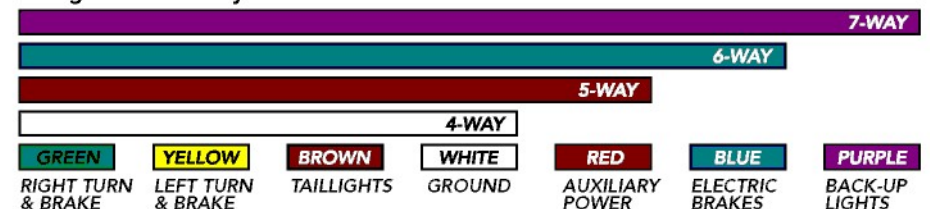

CURT DISCLAIMER: WIRING COLOR SHOWN WORK IN CONJUNCTION WITH CURT MANUFACTURING PRODUCTS.

12170

MAZDA CX-5

07/02/2020

GROSS LOAD CAPACITY WHEN USED AS A WEIGHT CARRYING HITCH: 3,500 LBS. TRAILER WEIGHT &amp; 350 LBS. TONGUE WEIGHT.

**WARNING: \*\*\* DO NOT EXCEED VEHICLE MANUFACTURER'S RECOMMENDED TOWING CAPACITY \*\*\***FOR MORE INFORMATION LOG ONTO [WWW.CURTMFG.COM](http://WWW.CURTMFG.COM) & FOR HELPFUL TOWING TIPS LOG ONTO [WWW.HITCHINFO.COM](http://WWW.HITCHINFO.COM)  
HAVING INSTALLATION QUESTIONS? CALL TECHNICAL SUPPORT AT 1-877-287-8634

Parts List			
ITEM	QTY	PART NUMBER	DESCRIPTION
1	3	10-10277	HHCS,M12x1.25,40CL10.9,YZ
2	2	10-10287	BOLT,CAR,1/2-13 UNC,1-1/2,GRD8,YZ
3	2	20-00062	NUT,SER-FLANGE,1/2-13 UNC,GRD8,YZ
4	3	30-00149	WASHER,S-CON,1/2,YZ
5	4	30-00133	WASHER,FLAT,1/2,YZ
6	2	CM-SP12	.250 x 1.00 x 2.00" SQUARE HOLE SPACER
7	2	1_2 FISHWIRE	1/2" FISHWIRE
8	2	600043	CABLE TIE 3/16 X 8" #50 UV BLACK

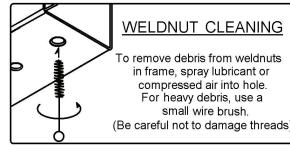

BE SURE TEETH ON ALL CONICAL WASHERS ARE AGAINST THE HITCH

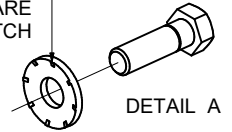

TOOLS REQUIRED	
3/4" & 19mm SOCKETS	
RATCHET	
TAPE	
FLATHEAD SCREWDRIVER	
PLIERS	
TORQUE WRENCH	
PRY BAR	
SAFETY GLASSES	

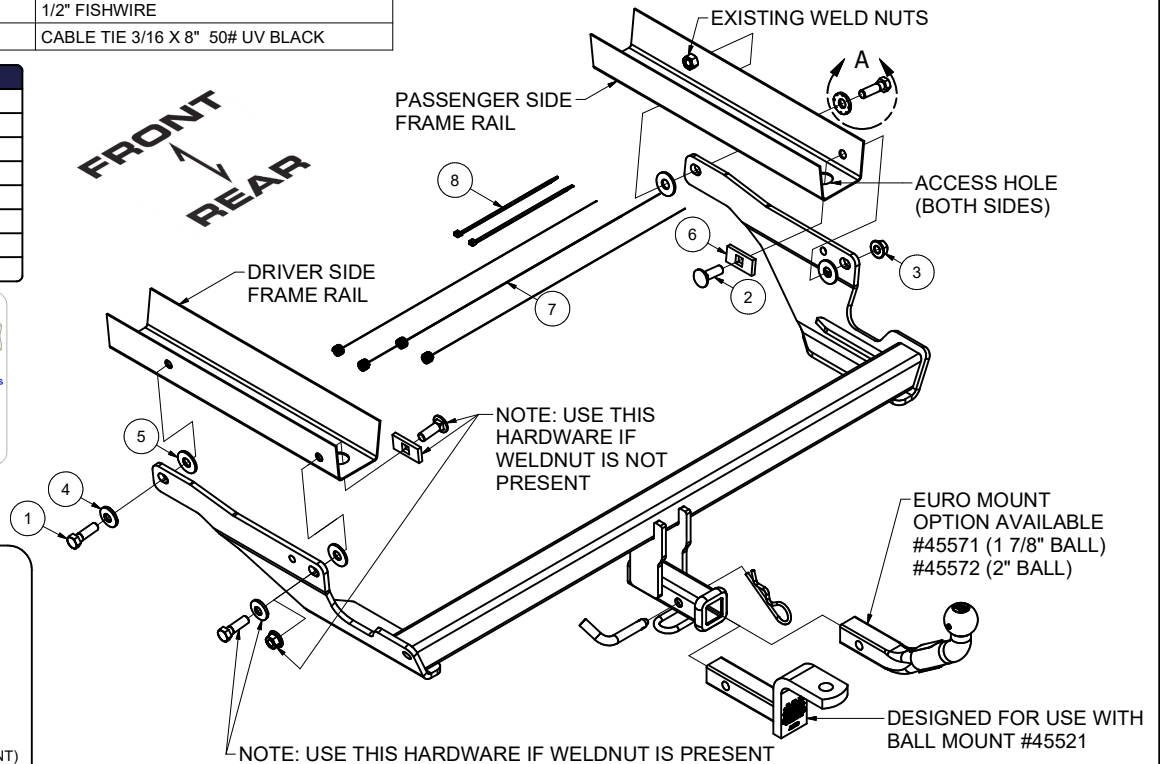
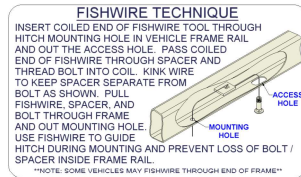

HITCH WEIGHT: 28 LBS.

INSTALL TIME

PROFESSIONAL: 20 MINUTES

NOVICE (DIY): 40 MINUTES

INSTALL NOTES:

- NO DRILLING REQUIRED
- LOWER EXHAUST
- FISHWIRE HARDWARE
- REMOVE PLASTIC PANEL (IF PRESENT)
- MAY REQUIRE WELD NUT CLEANING

## INSTALLATION STEPS

1. Remove plastic underbody panel under rear bumper (if present) by removing two plastic fasteners with a flat head screwdriver. Return panel & fasteners to vehicle owner.
2. Remove tape on the side of vehicle frame rails to expose mounting locations. Trim any excess seam seal (if it will interfere with hitch).
3. Remove plastic insert (if present) &/or electrical harness clip between hitch mounting locations on passenger side frame rail. Unfasten electrical harness clip on outside of the driver side frame rail & follow harness to unfasten nearest clip towards center of vehicle.
4. Lower exhaust by removing two to four (depending on vehicle) rearmost rubber hangers. Leave rubber hangers attached to the vehicle.
5. To ease installation tape four 1/2" flat washers into position on the inside of hitch side plates.
6. Fishwire 1/2" carriage bolt with CM-SP12 spacer in through access hole and out rearmost mounting location in the passenger frame rail. Repeat on rearmost mounting location in driver side frame rail (if there is no weldnut in frame). Leave hardware fully inside of frame rail(s) with fishwire(s) attached. See FISHWIRE TECHNIQUE diagram above.
7. Thread fishwire(s) through rearmost hitch mounting holes. Pull bumper fascia rearward and exhaust downward to get hitch into position.
8. Insert M12 bolts with conical toothed washers. Be sure the tooth side of washers are against the hitch and the 1/2" flat washers clamped in position between the hitch and frame rail.
9. Pull 1/2" hardware into position & remove fishwire(s). Fasten with 1/2" hex flange nut(s). Re-secure harness which was unfastened in step 3. Wrap cable tie(s) around hitch mounting plate(s) and harness. Pull tight & trim excess cable tie.
10. Torque all M12 hardware to 86.2 ft-lbs & 1/2" hardware to 110 ft-lbs.



Scan for more information

**PERIODICALLY CHECK THIS RECEIVER HITCH TO ENSURE THAT ALL FASTENERS ARE TIGHT AND THAT ALL STRUCTURAL COMPONENTS ARE SOUND.**

CURT Manufacturing LLC., warrants this product to be free of defects in material and/or workmanship at the time of retail purchase by the original purchaser. If the product is found to be defective, CURT Manufacturing LLC., may repair or replace the product, at their option, when the product is returned, prepaid, with proof of purchase. Alteration to, misuse of, or improper installation of this product voids the warranty. CURT Manufacturing LLC.'s liability is limited to repair or replacement of products found to be defective, and specifically excludes liability for incidental or consequential loss or damage.

This product complies with safety specifications and requirements for connecting devices and towing systems of the state of New York, V.E.S.C.Regulation V-5 and SAE J684.