

INSTALLATION MANUAL

70103

Level of Difficulty

Difficult

Installation difficulty levels are based on time and effort involved and may vary depending on the installer level of expertise, condition of the vehicle and proper tools and equipment.

Installed Attachment Tabs

Height	20"
Width	37-1/4"

Parts List

Item	Qty	Description
1	1	Tow bar base plate, driver
2	1	Tow bar base plate, passenger
3	2	Tow bar mounting tab
4	2	Safety cable, 7,500 lbs.
5	2	Conical washer, 1/2"
6	2	Hex bolt, 1/2"-13, 5", grade 5
7	2	Round hole spacer, 2" x 1/4"
8	2	Quick link, 1/2"
9	2	Socket plug

Tools Required

Torque wrench	Drill
Socket, 3/4"	Drill bit, 1/4"
Socket, 8mm	T27 Torx bit
Socket, 10mm	Flat screwdriver
Socket, 15mm	Wrench, 3/4"
Socket, 16mm	--

⚠ WARNING

Never exceed the vehicle manufacturer's recommended gross vehicle weight rating (GVWR).

Product Photo



Not pictured: Safety cables, quick links and socket plugs

⚠ CAUTION

Take care when cutting any plastic or metal as injury may occur if done improperly.

NOTICE

Visit www.curtmfg.com for a full-color copy of this instruction manual, as well as helpful videos, guides and much more!

Before you begin installation, read all instructions thoroughly.

Proper tools will improve the quality of installation and reduce the time required.

This installation requires front fascia panels to be temporarily removed. The tow hooks and frame rail extensions will not be reinstalled and should be returned to the vehicle owner.

To help prevent damage to the product or vehicle, refer to the specified torque specifications when securing hardware during the installation process.

If equipped, we recommend removing the base plate attachment tabs when not in use.

SAFETY INSTRUCTIONS

Safety glasses should be worn at all times while installing this product.

Product Registration and Warranty

CURT stands behind our products with industry-leading warranties. To get copies of the product warranties, register your purchase or provide feedback, visit: warranty.curtgroup.com/surveys

ASSEMBLY

Parts List

Item	Qty	Description
1	1	Tow bar base plate, driver
2	1	Tow bar base plate, passenger
3	2	Tow bar mounting tab
4	2	Safety cable, 7,500 lbs.
5	2	Conical washer, 1/2"
6	2	Hex bolt, 1/2"-13, 5", grade 5
7	2	Round hole spacer, 2" x 1/4"
8	2	Quick link, 1/2"
9	2	Socket plug

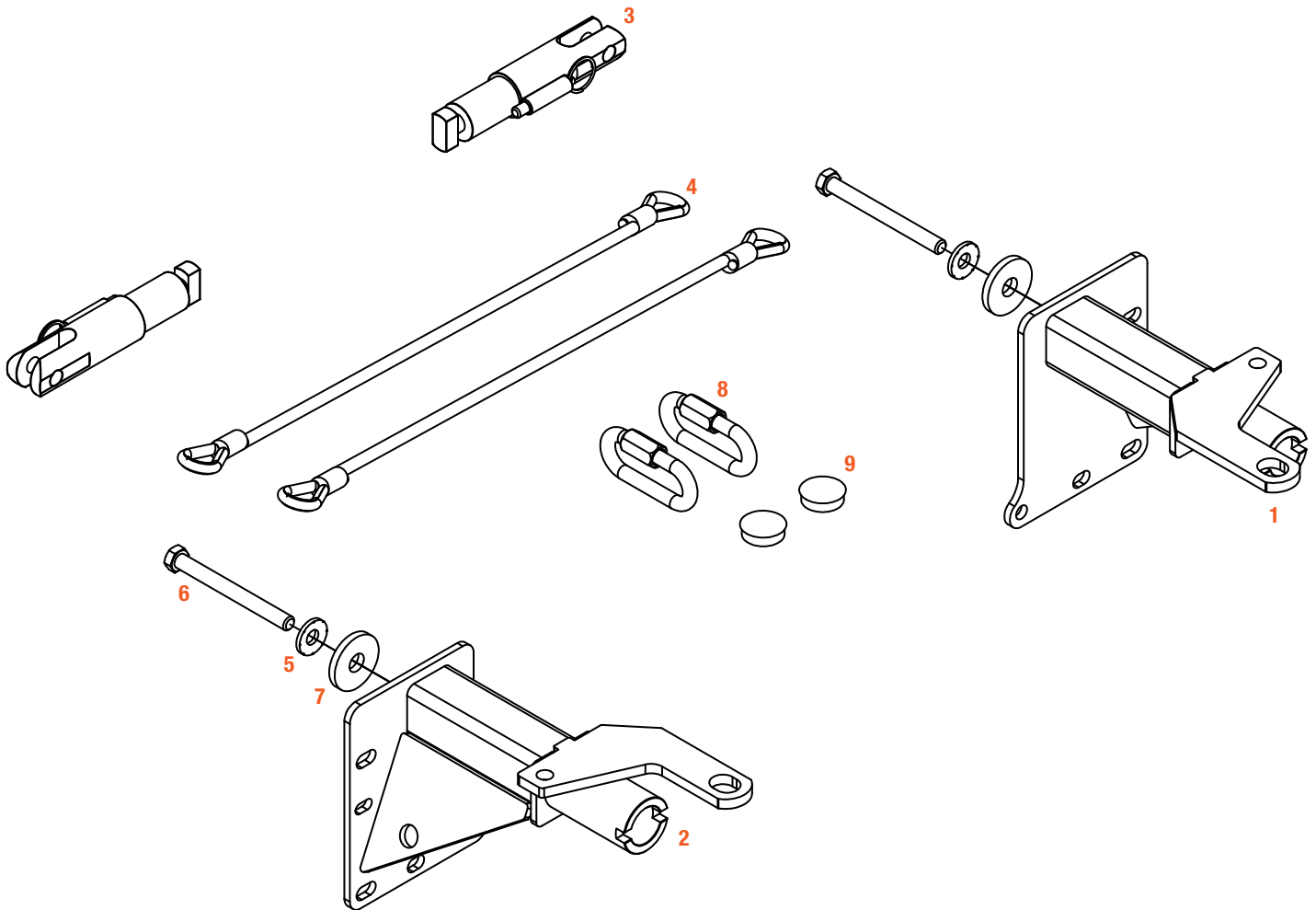

FASCIA REMOVAL

Step 1

Open the hood and remove the radiator cover by pulling out the 13 push pins – six on either side of the vehicle and one in the center.

Once removed, set the cover aside.



Step 2

Use a T27 Torx bit to remove the two screws behind the radiator cover attaching the bumper cover, one on either side of the vehicle.

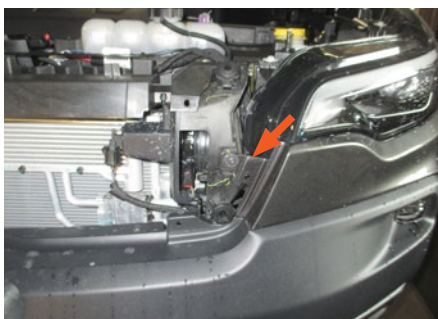

Step 3

Use an 8mm socket to remove the three wheel well liner bolts. Then, pull the liner back and use a 10mm socket to remove the bolt behind the liner at the fender and bumper cover seam.

Repeat on the other side of the vehicle.

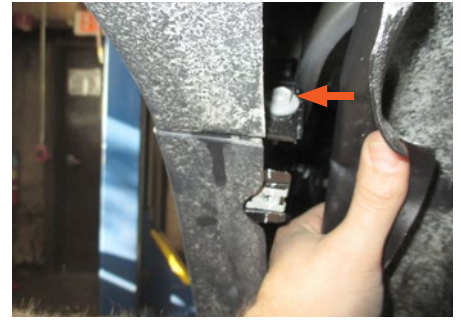

Step 4

Remove the two rivets located on the underside corner of the front fascia panel – one on either side of the vehicle. Then, use a 10mm socket to remove the four underside bolts holding the fascia in place – two on either side of the vehicle.

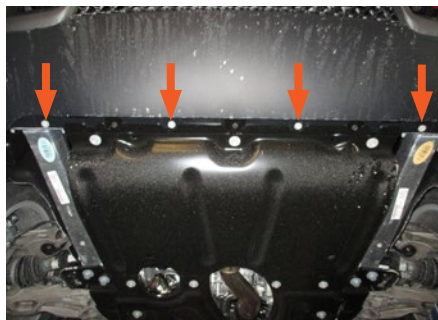

Step 5

Starting on the outer edges, insert a screw driver between the tabs where the screw was located inside the fender seam and twist to release the clip. Firmly but carefully pull the fascia panel out, releasing the clips in the fender seam. Do not break the tabs!

Work your way toward the center of the vehicle, unclipping the fascia. It may be required to pull up on the bumper cover to release the last clips under the headlights.

Make sure to unplug the foglight wiring harnesses on both sides if present as well as the electrical connection on the driver side by pulling out the yellow clip and sliding the red lock toward the yellow clip.

Carefully remove the bumper cover and set aside so it will not be damaged during the rest of the installation.

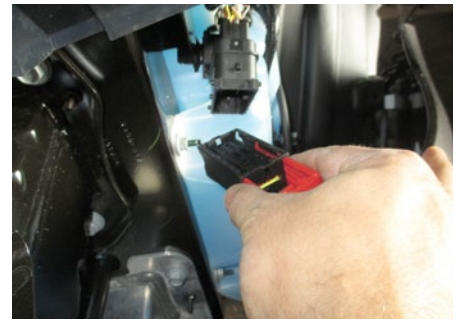
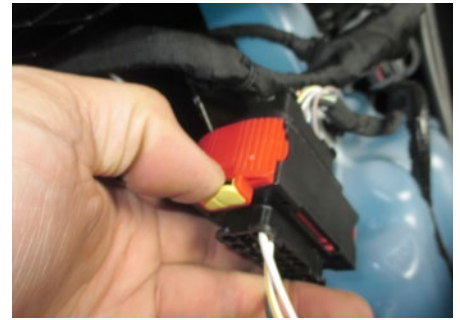
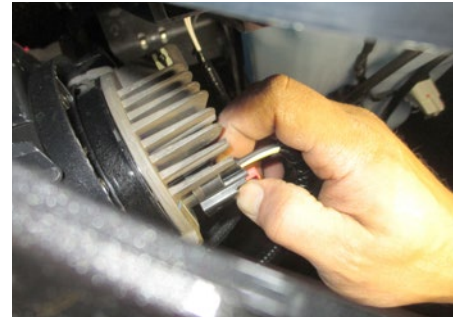

TOW BAR BASE PLATE INSTALLATION

Step 6

Use a 16mm socket to remove the two bolts on the underside of the tow hook bracket. Then, use a 30mm socket to remove the backside tow hook nut.

Once removed, set the tow hook aside.

Repeat on the other side of the vehicle.

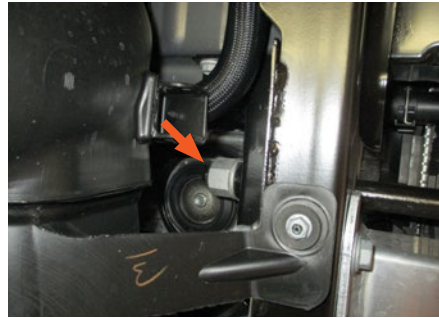
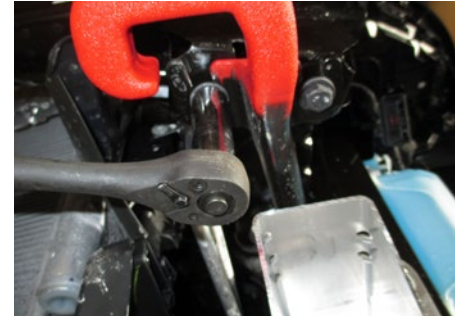

Step 7

Use a 15mm socket to remove the three bolts holding the frame extension in place. Then, use a 10mm socket to remove the nut. **Note:** certain models are equipped with a clip instead of a nut.

Repeat on the other side of the vehicle.

Return the tow hooks and frame extensions to the vehicle owner.



Step 8

On the driver side, position the tow bar base plate (#1) and secure it using the four factory bolts removed in Steps 6 and 7 (one of the tow hook bolts and the three from the frame extensions).

Torque the bumper bolt first, then the three frame bolts, each to 45.2 lb-ft.

Repeat on the passenger side of the vehicle.

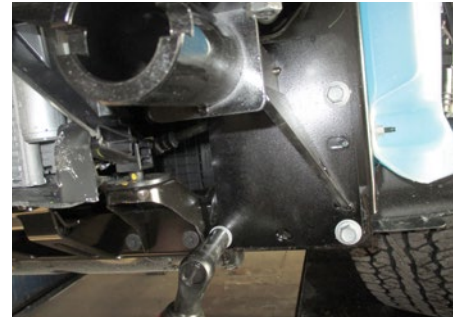
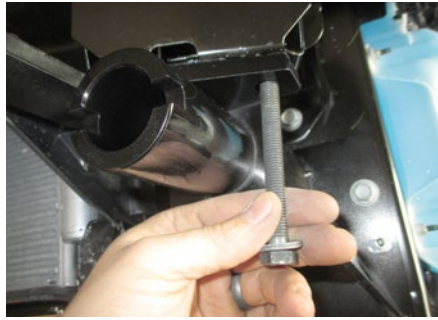
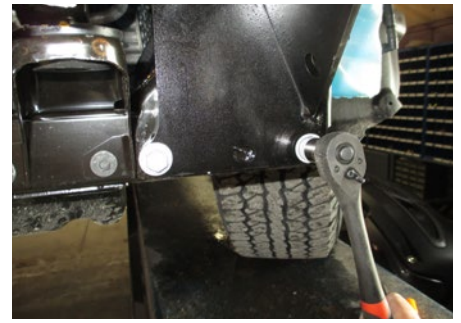
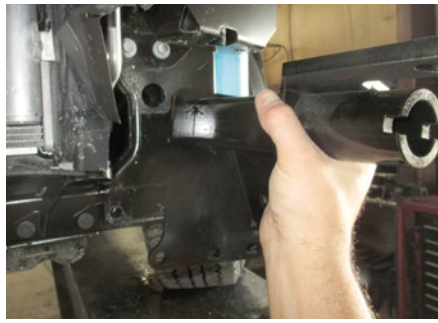

Step 9

On the backside of the base plate (#1), install a supplied 1/2" hex bolt (#6) with a conical washer (#5) and 1/4" thick, round-hole spacer (#7).

Torque the 1/2" x 5" hardware to 75 lb-ft.

Repeat on the other side of the vehicle

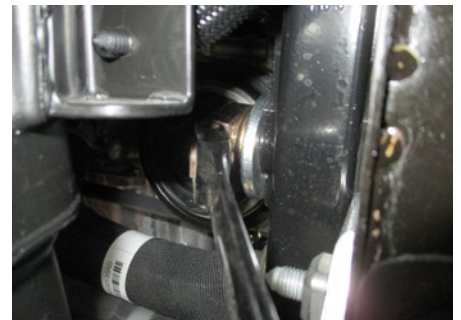

Step 10

Install the permanent safety cables (#4) and quick links (#8), looping them around the vehicle frame and linking them to the tow bar base plates (#1,#2). There must be one cable on each side of the vehicle.

Make sure the cables do not pinch or interfere with any hoses, wiring or other components.

See 'Installing the Permanent Base Plate Safety Cables' for additional information.



Step 11

Reinstall the bumper cover and all panels that were previously removed and plug in the wiring harnesses removed in Step 5. **Note:** To secure the underside of the fascia, we recommend installing new push pins or plastic rivets.

When ready to tow, install the tow bar mounting tabs (#3). When not towing, insert the socket plugs (#9) into the ends of the tow bar base plates (#1,#2).



Final Installed Image



SAFETY CABLE INSTALLATION

Installing the Permanent Base Plate Safety Cables

When dinghy towing a vehicle with a tow bar, base plate safety cables should be used at all times. In the event of a disconnect, the safety cables are designed to help prevent complete vehicle separation. When installing the safety cables, use the illustrations below as a guide.

Installation guidelines

1. The cables must be connected to the base plate and the vehicle frame.
2. Two cables must be installed.
3. Each cable must meet or exceed the gross weight of the towed vehicle.
4. Make sure cables do not pinch or interfere with hoses, wiring or other components.

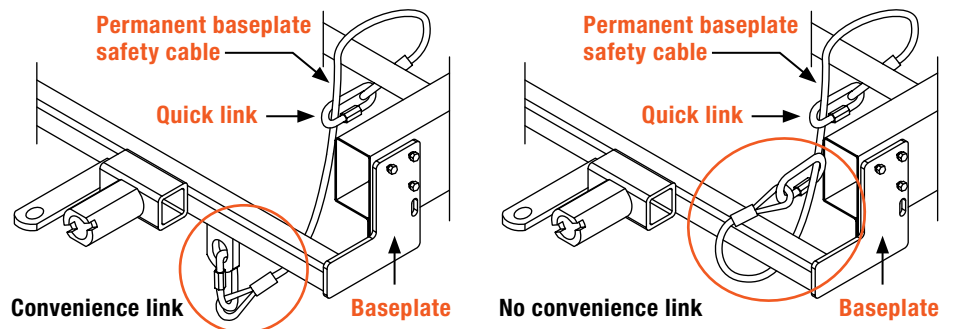

Note: Base plate safety cables are not a replacement for safety chains connecting the tow vehicle to the towed vehicle.

ADDITIONAL INFORMATION

Towing Tips

Check your equipment

Periodically check the condition of all towing equipment. Ensure all fasteners are tight and that all structural components are sound. Do not tow with worn or damaged parts.

Towing vehicle and trailer manufacturer's recommendations

Review the owner's manual for your towing vehicle and trailer for specific recommendations, capacities and requirements.