



**Before returning this product
to the store of purchase**

Contact Dee Zee if you experience the following problems:

- Missing Parts
- Installation Problems/Questions
- Warranty Questions

1.800.779.2102

Hours of operation: 8am - 5pm CST, Mon-Friday

Review complete warranty policy and register your product at:

www.deezee.com



Dee Zee Running Board Installation Instructions

Congratulations on your purchase of a quality Dee Zee product. Dee Zee is recognized as having the highest quality running boards and accessories on the market today. We have earned this reputation by offering our customers a product they can be proud to place on their vehicles. Dee Zee meets all the criteria of manufacturing a custom-fit product which guarantees it to be the easiest product to install.

Note: Please take time to read all of the instructions before beginning this installation.

Warning! Please check for wiring or other obstructions before drilling any holes into the vehicle. If it is necessary to drill any holes into the vehicle, Dee Zee recommends putting a sealant or rust inhibitor around all holes drilled into the body of the vehicle.

Warning! It is the sole responsibility of the vehicle owner to check for tire clearance.

Warning! It is unlawful and dangerous to ride on running boards or side box boards while the vehicle is in motion.

Cleaning Instructions: To maintain the bright finish of your Dee Zee running boards, clean with a mild detergent. For our stainless steel products and accessories, the application of a high grade automotive type wax is recommended.







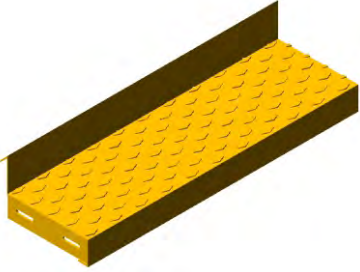

**If you should happen to have any questions with this product or you have an installation question, please feel free to call us at:
1-800-779-8222**

**If you would like to find out more information on Dee Zee's products please feel free to visit our website at:
WWW.DEEZEE.COM**

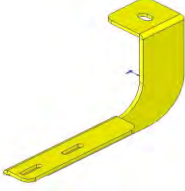
Dee Zee Britetread Running Board Installation Instruction

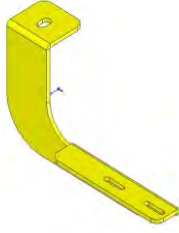
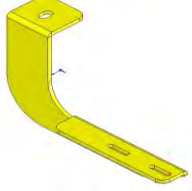
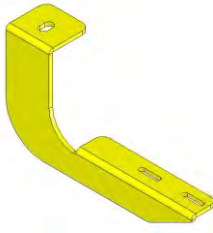
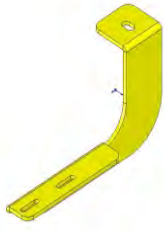
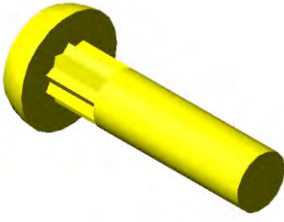
DZ 1053

(1999 - Current) Chevy Crew Cab Pickup

<p>A Britetread Running Board</p>  <p>X2</p>	<p>B Bulb Seal Gasket</p>  <p>15.00 ft.</p>	<p>C Mudflaps</p>  <p>X2</p>	
<p>E Front Driver Side Body Mount Bracket</p>  <p>X1</p>	<p>F Middle Driver Side Body Mount Bracket</p>  <p>This is the shortest in the kit X1</p>	<p>G Rear Driver Side Body Mount Bracket</p>  <p>This is the tallest in the kit X1</p>	<p>H Front Passenger Side Body Mount Bracket</p>  <p>X1</p>
<p>I Middle Passenger Side Body Mount Bracket</p>  <p>This is the shortest in the kit X1</p>	<p>J Rear Passenger Side Body Mount Bracket</p>  <p>This is the tallest in the kit X1</p>	<p>K 1/4 x 3/4" Carriage Head Bolt</p>  <p>PN 87 X12</p>	<p>L 1/4" Flat Washer</p>  <p>PN 72 X16</p>
<p>M 1/4" Hex Nut</p>  <p>PN 71 X16</p>	<p>N 1/4 x 1" Sheet Metal Screw</p>  <p>PN 97 X4</p>	<p>O 1/4 x 3/4" Hex Head Bolt</p>  <p>PN 70 X4</p>	

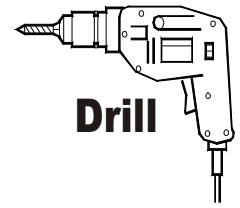
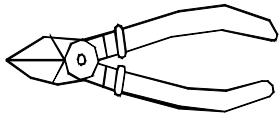
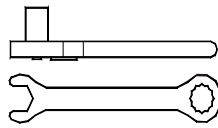
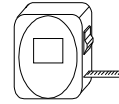
Tools Required:**Ratchet / Wrench****Drill****Tin-snips****Sizes:****18mm****7/16"****3/8"****Tape Measure****3/16" Drillbit****1/4" Drillbit****1**

Secure britetread mudflap (C) to britetread running board (A) using 1/4 x 3/4" hex head bolts (O), 1/4" flat washers (L), and 1/4" hex nuts (M). Tighten into place using a 7/16" wrench / or socket. Place bulb-seal gasket (B) onto the backlip of britetread running board (A) and trim flush with the britetread mudflap (C) and the end of britetread running board (A).

Fixez le mudflap de britetread (c) au panneau courant de britetread (a) à l'aide des boulons de tête de sortilège de 1/4 x de 3/4"(o), des rondelles plates de 1/4" (l), et des écrous 1/4"de sortilège (m). Serrez dans l'endroit à l'aide d'une clé de 7/16"/ou de la douille. Placez la garniture d'ampoule-joint (b) sur le backlip du panneau courant de britetread (a) et équilibrez à affleurement du mudflap de britetread (c) et de l'extrémité du panneau courant de britetread (a).

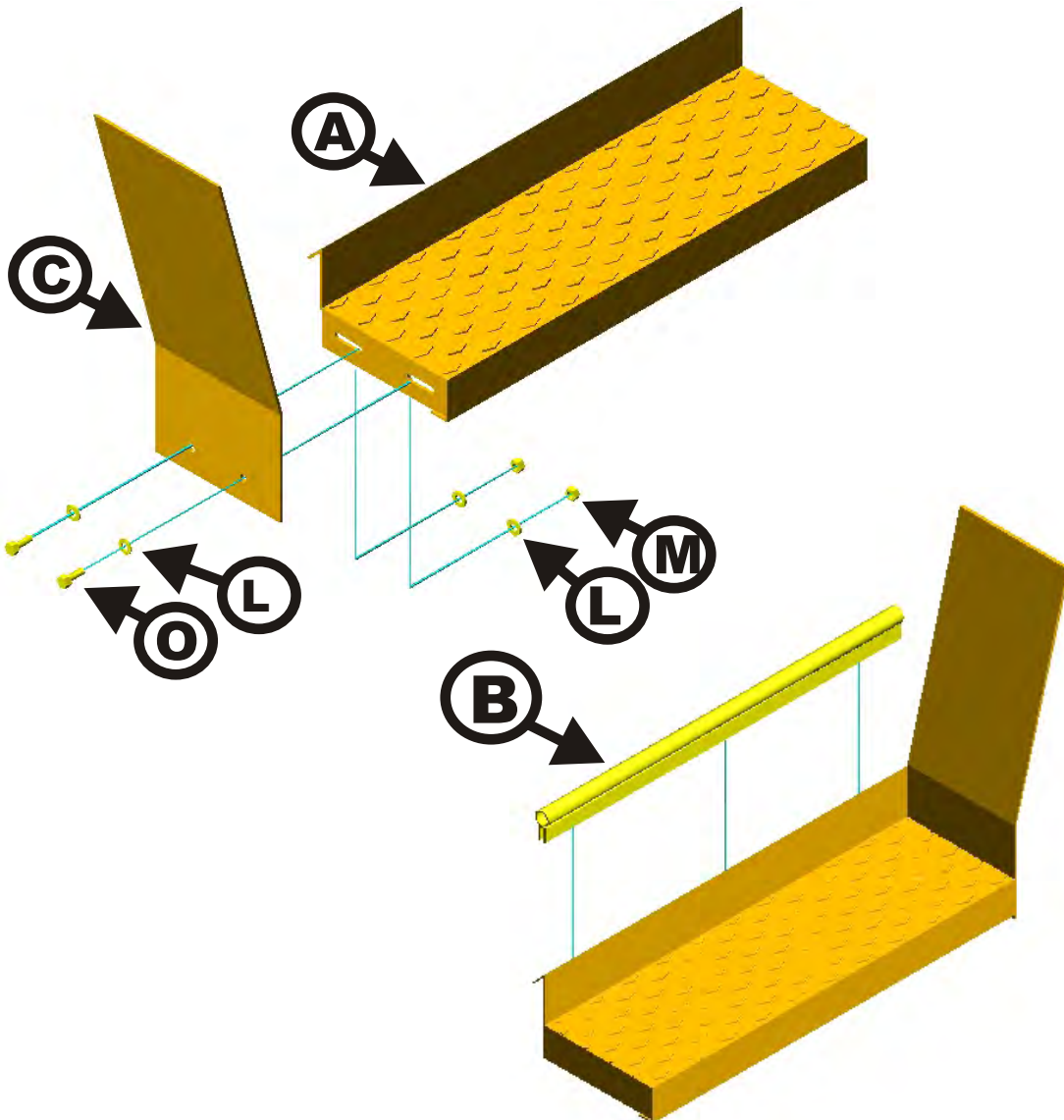
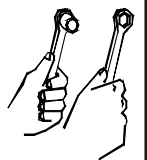
**Britetread
Running Board****7/16" Wrench
or Socket**

2

Locate and remove the front / rear body mount bolts shown below using an 18mm socket/ratchet. Do not discard the body mount bolt or rubber bushing. They will be used in the next step of this installation.

Plac et enlevez boulons avant/arrière de bâti de corps montrés au-dessous d'employer un 18mm socket/ratchet. Ne jetez pas la douille de boulon ou en caoutchouc de bâti de corps. Ils seront employés dans la prochaine étape de cette installation.

**18mm Wrench
or Socket**

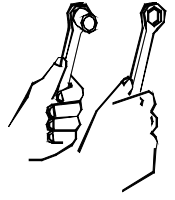

Front Body Mount



Middle Body Mount



Rear Body Mount

3**Front / Middle / Rear**

Place the body mount bolt through the hole in the front body mount bracket and the rubber bushing. Place this assembly up to the body mount locations and loosely hand tighten into place. See below.

La frente/el Centro/Trasero

Coloca el cerrojo del monte del cuerpo por el hoyo en el paréntesis anterior del monte del cuerpo y el buje de caucho. Coloque esta asamblea hasta las ubicaciones del monte del cuerpo y flojamente mano aprieta en el lugar. Vea abajo.

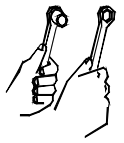
**18mm Wrench
or Socket**

Front Body Mount



Middle Body Mount

(Looking towards the front of the truck)



Rear Body Mount

(Looking towards the front of the truck)

4

Place the running board up to the front / rear body mount brackets. Make any final adjustments to the alignment of the running board on the vehicle and then use the existing slots in the body mount brackets to drill 1/4" holes through the running board. Secure into place using 1/4 x 1" ribneck carriage head bolts (J), 1/4" flat washers (K), and 1/4" flat washers (L). Tighten into place using a 7/16" wrench / or socket. Note: It is important that all adjustments to the running board and side box board alignment are made prior to drilling any holes in the board.

Placez le conseil courant jusqu'à parenthèses avant/arrière de bâti de corps. Faites tous les ajustements finals à l'alignement du conseil courant sur le véhicule et puis employez les fentes existantes dans les parenthèses de bâti de corps pour forer des trous de 1/4" par le conseil courant. Fixez dans l'endroit en utilisant les boulons de tête de chariot de ribneck de 1/4 x de 1"(j), les rondelles plates de 1/4" (k), et les rondelles plates de 1/4"(l). Serrez dans l'endroit à l'aide d'une clé de 7/16"/ou de la douille.

7/16" Wrench
or Socket

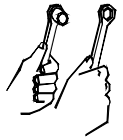

Drill with a
1/4" drillbit

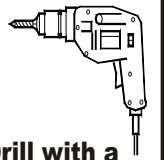

Bracket to Board Mount

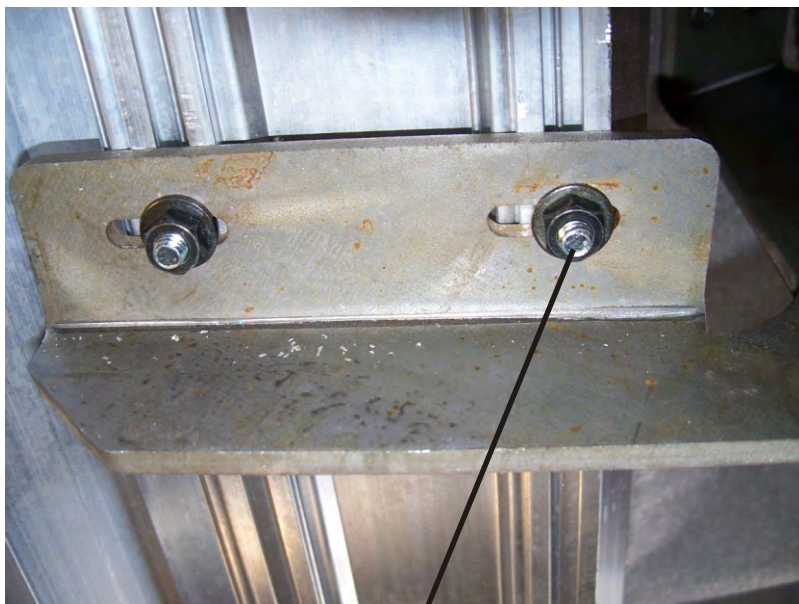

K L M

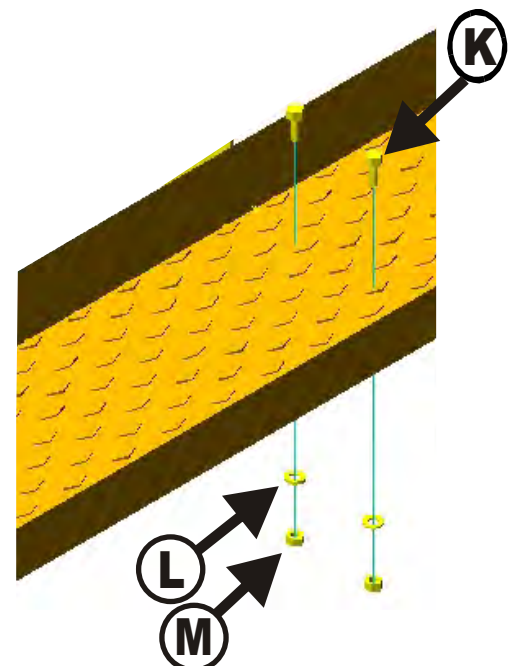
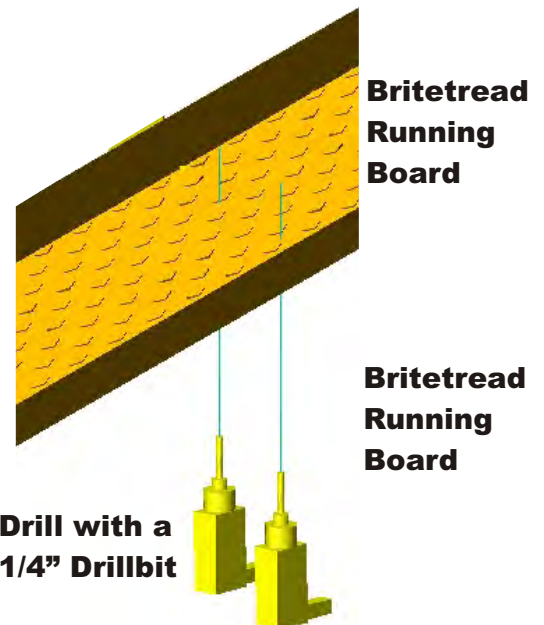

5

Drill two holes through the britetread mudflap and the sheet metal of the vehicle wheel well opening. Secure the britetread mudflap to the vehicle wheel well opening using 1/4 x 1" sheet metal screws (N). Tighten into place using a 3/8" wrench / or socket.

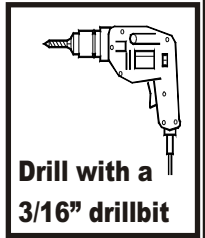

Forez deux trous par le mudflap de britetread et le métal de feuille de l'ouverture de soute de train de véhicule. Fixez le mudflap de britetread à l'ouverture de soute de train de véhicule à l'aide des vis en métal de feuille de 1/4 x de 1"(mj). Serrez dans l'endroit à l'aide d'une clé de 3/8"/ou du plot.

