

# FENDER FLARES INSTALLATION INSTRUCTIONS FRONT FENDERS

FF 640  
1/2

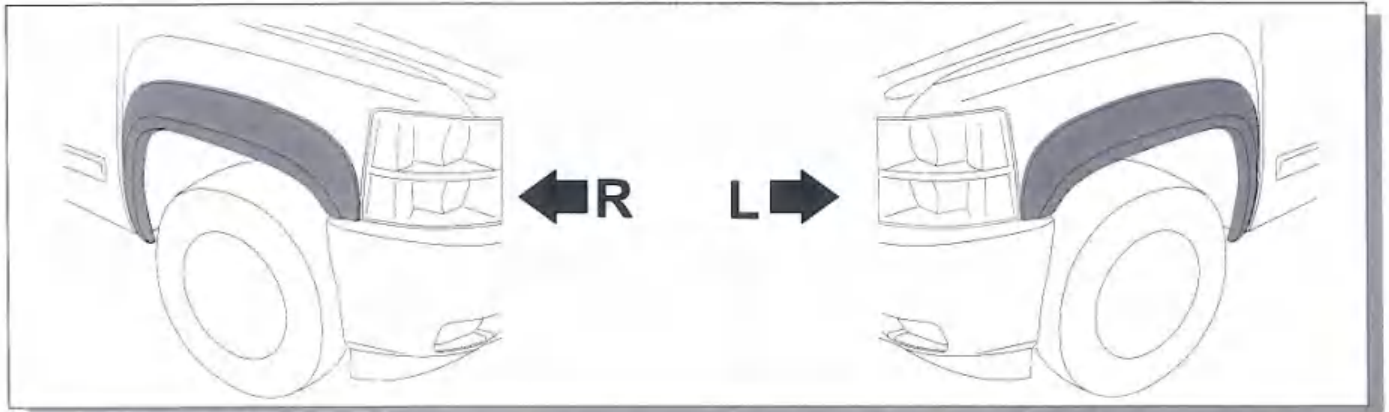

1. Ensure that both left and right hand Fender Flares suit the profile of the vehicle. Note the areas where the Fender Flares come in contact with the vehicle. **NOTE:** Before fitting Fender Flares remove any mouldings, strips or existing flares from the wheel arch. If there is a body side moulding, mark where the moulding is to be cut, alternatively the Fender Flares can be cut to go around the moulding. Be sure to allow enough room for the extrusion.

**PAINTING INSTRUCTIONS – If Fender Flares are being painted, do not install edge extrusion until painting is complete.** Prior to painting, clean all surfaces to be painted using clean water and a mild detergent, do not use lacquer thinner or any solvent based products. Wipe completely dry. Best results will be achieved by wiping the areas to be painted with a tack rag just prior to painting. Most automotive paints can be applied directly to the Fender Flares, however some may require a primer (check paint manufacturer specifications). Good adhesion will be achieved without sanding. Select a paint (and primer if necessary) that is suitable for rigid plastics PMMA (Acrylic). If using a paint system which requires baking, do not expose the product to temperatures above 70°C (158°F). Do not fit the extrusion or any of the hardware to the Fender Flares until the paint is completely dry.

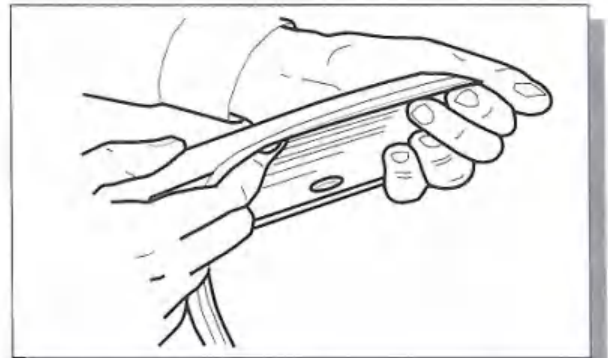
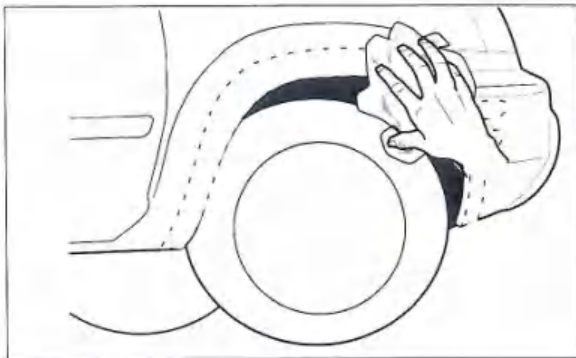

2. Wash the areas of contact on the vehicle and wipe dry both the vehicle and the Fender Flares with a clean cloth. Ensure inside of Fender Flares where extrusion is attached is clean, use alcohol wipe supplied to clean surface.
3. Remove approximately 2" (50mm) of the protective liner from the extrusion. Fit the extrusion to the Fender Flare along the edge that comes in contact with the vehicle's body panel.

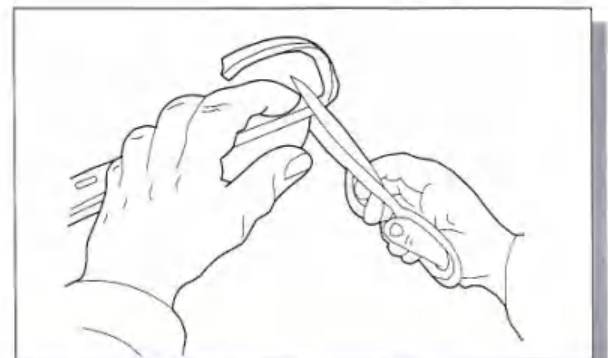
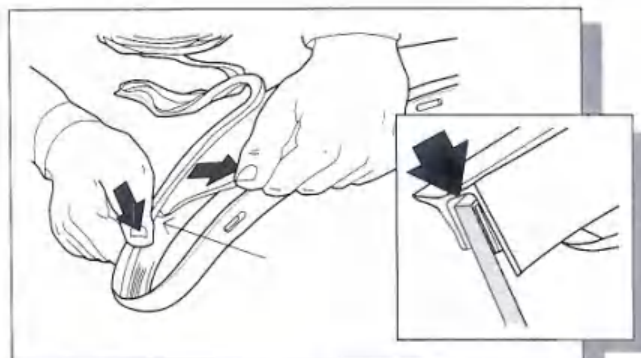

4. Pulling at right angles to the extrusion, remove the liner from the extrusion in small portions and apply
5. Trim any unnecessary extrusion and discard.

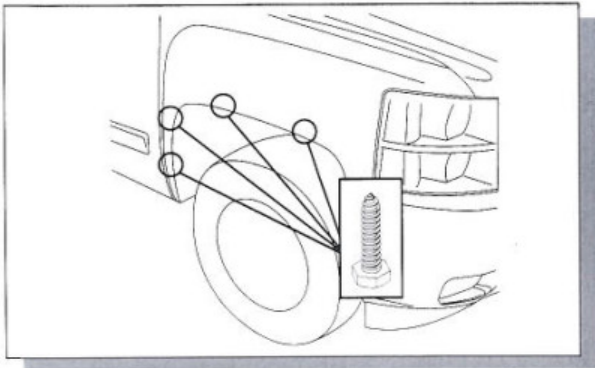

- 6.** Use the original manufacturer's hardware that is in the wheel arch of the vehicle to fit the Fender Flares. Remove the 7mm socket head screws from the fasteners on the vehicle.

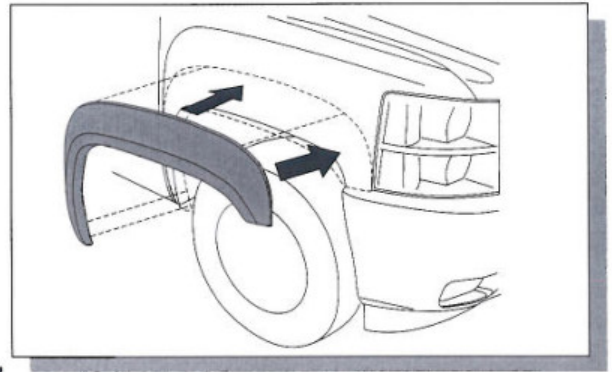

- 7.** Place the front Fender Flares onto the vehicle and line up the holes on the part with those of the screw holes on the vehicle.

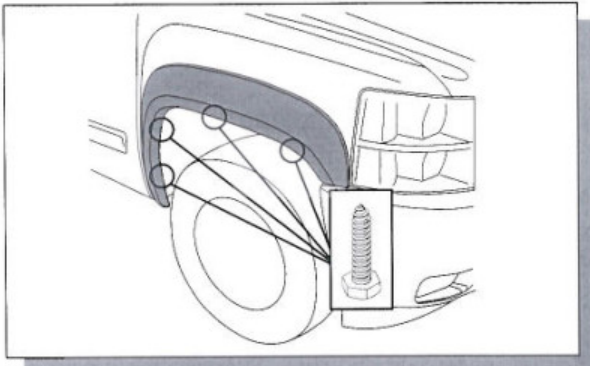

- 8.** Re-Install the socket head screws into the fender to secure the Fender Flares. Fit the Fender Flares loosely until the Fender Flares are aligned as desired, when satisfied, tighten the screws fully and ensure extrusion is flush neatly against the body.



CLEAN FLARES  
WITH MILD  
DETERGENT  
ONLY. NO



# REAR FENDER FLARES INSTALLATION INSTRUCTIONS

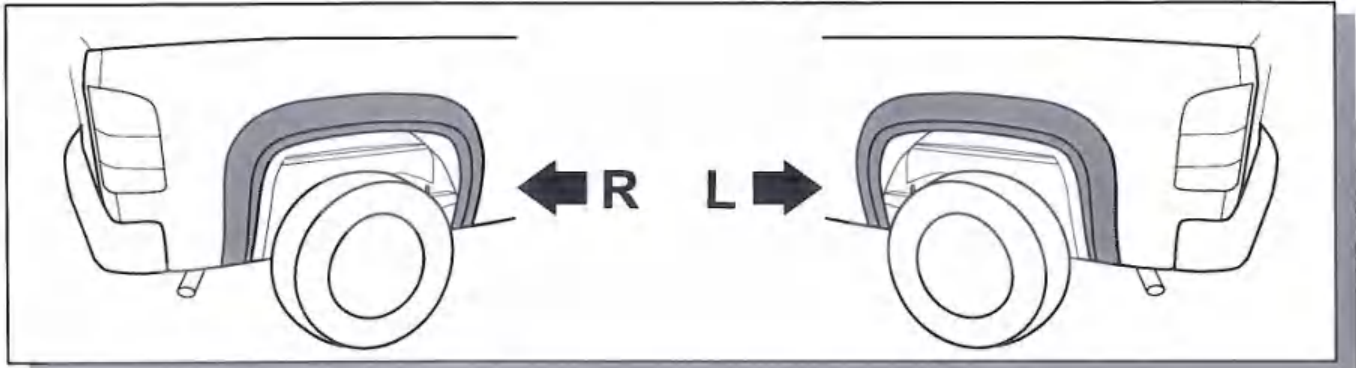

1. Ensure that both left and right hand Fender Flares suit the profile of the vehicle. Note the areas where the Fender Flares come in contact with the vehicle. **NOTE:** Before fitting Fender Flares remove any mouldings, strips or existing flares from the wheel arch. If there is a body side moulding, mark where the moulding is to be cut, alternatively the Fender Flares can be cut to go around the moulding. Be sure to allow enough room for the extrusion.

**PAINTING INSTRUCTIONS – If Fender Flares are being painted, do not install edge extrusion until painting is complete.** Prior to painting, clean all surfaces to be painted using clean water and a mild detergent, do not use lacquer thinner or any solvent based products. Wipe completely dry. Best results will be achieved by wiping the areas to be painted with a tack rag just prior to painting. Most automotive paints can be applied directly to the Fender Flares, however some may require a primer (check paint manufacturer specifications). Good adhesion will be achieved without sanding. Select a paint (and primer if necessary) that is suitable for rigid plastics PMMA (Acrylic). If using a paint system which requires baking, do not expose the product to temperatures above 70°C (158°F). Do not fit the extrusion or any of the hardware to the Fender Flares until the paint is completely dry.

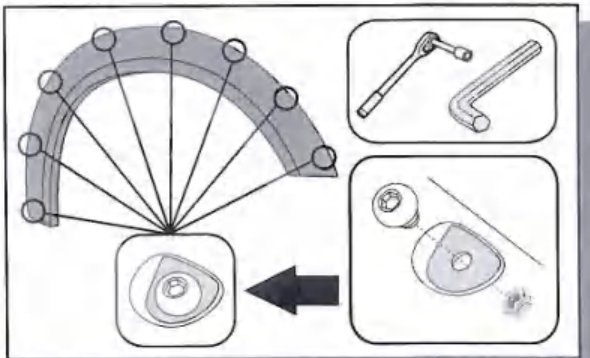

2. Attach bolts to each Fender Flare using a 3/16" Allen key and a 1/2" wrench/socket.

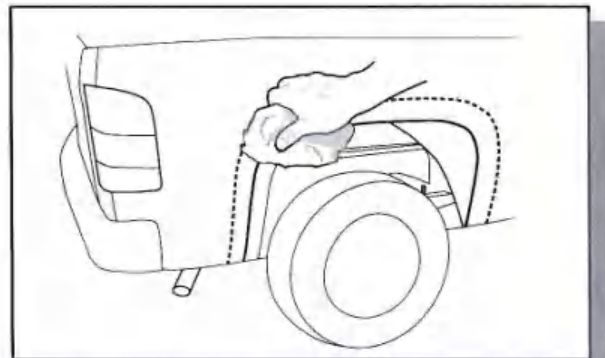

3. Wash the areas of contact on the vehicle and wipe dry both the vehicle and the Fender Flares with a clean cloth. Ensure inside of Fender Flares where extrusion is attached are clean, use alcohol wipe supplied to clean surface.

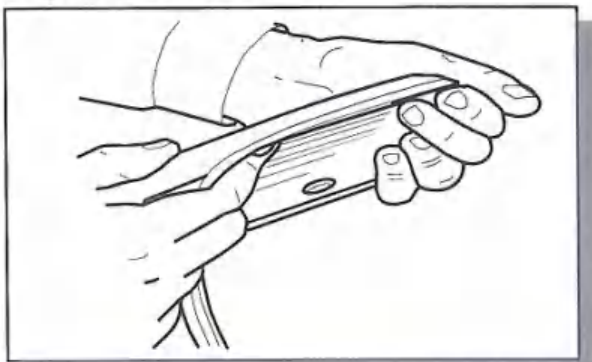

4. Remove approximately 2" (50mm) of the protective liner from the extrusion. Fit the extrusion to the Fender Flares along the edge that comes in contact with the vehicle's body panel, ensuring the double sided tape is being adhered to the inside surface of the fender

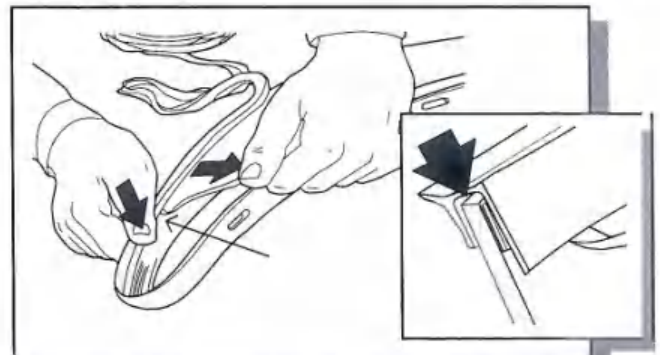

5. Pulling at right angles to the extrusion, remove the liner from the extrusion in small portions and apply thumb

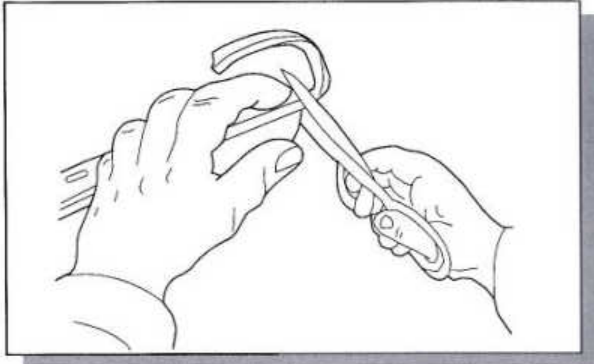

- 6.** Trim any unnecessary extrusion and discard.



CLEAN FLARES  
WITH MILD  
DETERGENT  
ONLY, NO  
ABRASIVE  
CLEANERS.

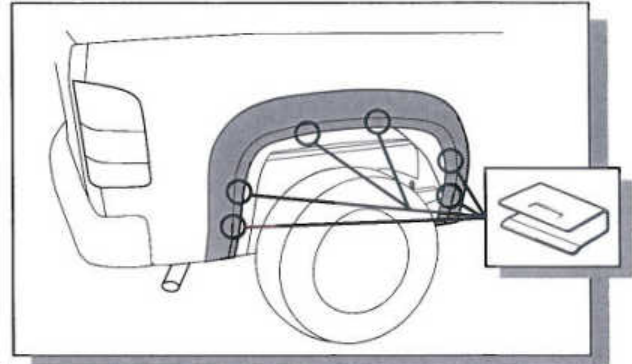

- 7.** To secure the Fender Flare to the body, take the black metal clips and slide them over the Fender Flare and inner wheel arch lip. Position clip so that the barb in the clip locates in the slot in the Fender Flare. Ensure all fixing points are secure and that extrusion is flush neatly against the body.

**IMPORTANT:** Repeat process for LHS of vehicle.