

2360 Boswell Road
Chula Vista, CA 91914
Phone 619.216.1444
Fax 619.216.1474
E-Mail tech@explorerprocomp.com



PRO COMP SUSPENSION

Suspension Systems that Work!

**Part # 57289
Toyota 4WD IFS
Stage II
'86-'95**

This document contains very important information that includes warranty information and instructions for resolving problems you may encounter. Please keep it in the vehicle as a permanent record.

Box 1 of 2-PN 57289-1

Part #	Description	Qty.	Illus.	Page
90-1290	Rear Crossmember	1	3-4	
90-3375	Front A-Arm Drop Brkt. - Drvr.	1	3	
90-3377	Front A-Arm Drop Brkt. - Pass.	1	3	
90-3372	Rear A-Arm Drop Brkt. - Drvr.	1	3	
90-3371	Rear A-Arm Drop Brkt. - Pass.	1	3	
90-2154	Compression Strut - Drvr.	1	11	
90-2155	Compression Strut - Pass.	1	11	
90-6108	Bracket Pack Containing:			
90-55089-5	Front Brake Drop Down Bracket	2	1	
90-1280	Rear Brake Drop Down Bracket	1	12	
90-1277	Center Differential Bracket	1	5	
90-1282	Differential Drop Brkt. - Pass	1	6	
90-1283	Differential Drop Brkt. - Drvr.	1	7	
90-1278	Sway Bar Drop Down Brkt. - Pass.	1	10	
90-1279	Sway Bar Drop Down Brkt. - Drvr.	1	10	
90-1276	Rear Brake Cable Exten. Bracket	1	13	
90-6125	Hardware Pack Containing:			
70-0504001500	1/2" x 4" USS Gd 5 Hex Bolt	2	11	
72-05000100512	1/2" USS Nyloc Nut	2	11	
73-0505000030	1/2" SAE Flat Washer	4	11	
90-6124	Compression Strut Bushing And Sleeve Pack			
90-2109	Sleeves, 3/4" x .095 x 2.75	2	11	
15-11148	Bushing - Red	4	11	
90-6110	Hardware Pack Containing:			
70-0622501500	5/8" x 2 1/2" USS Gd. 5 Hex Bolt	2	8	
70-0624501500	5/8" x 4 1/2" USS Gd. 5 Hex Bolt	4	3	
70-0502501500	1/2" x 2 1/2" USS Gd. 5 Hex Bolt	1	5	
70-0502251500	1/2" x 2 1/4" USS Gd. 5 Hex Bolt	1	5	
70-0501251500	1/2" x 1 1/4" USS Gd. 5 Hex Bolt	3	6-7	
72-06200100512	5/8" USS Nyloc Nut	6		
72-05000100512	1/2" USS Nyloc Nut	5		
73-05000030	1/2" SAE Flat Washer	10		
	Loctite Tube Red	1		
90-6111	Hardware Pack Containing:			
70-0431001500	7/16" x 1" USS Gd. 5 Hex Bolt	8		
70-0371001500	3/8" x 1" USS Gd. 5 Hex Bolt	7		
70-0311001500	5/16" x 1" USS Gd. 5 Hex Bolt	6		
72-04300100512	7/16" USS Nyloc Nut	8		
72-03700100512	3/8" USS Nyloc Nut	7		
72-03100100512	5/16" USS Nyloc Nut	6		
73-04300030	7/16" SAE Flat Washer	16		
73-03700030	3/8" SAE Flat Washer	14		
73-03100030	5/16" SAE Flat Washer	6		
90-6109	Bracket Bag Containing:			
90-1301	Locating Washer, Toyota	8	3	
90-2014	Spacer, .750" x .120 Wall x .250"	1	5	
90-2022	Sleeve, .750 .510 ID x .870"	1	5	
90-2136	Spacer Tube, .750" x .120 Wall x 1.220"	1	5	
96-4026	Spindle Cone Spacer - Toyota	2	8	

Part #	Description	Qty.	Illus.	Page
Box 2 of 2-PN 57289-2				
90-4009	Spindle Adapter - Drvr.	1	8	
90-4010	Spindle Adapter - Pass.	1	8	

THE FOLLOWING PARTS ARE USED IN CONJUNCTION WITH THIS KIT, AND MUST BE ORDERED SEPARATELY.

318514	ES3000 SHOCKS (FRONT)	2	
326506	ES3000 SHOCKS (REAR)	2	
	'86-'89 4-RUNNER		
	'86-'95 PICKUP		
-OR-			
326513	ES3000 SHOCKS (REAR)		
	'90-'95 4-RUNNER		

ONE OF THE FOLLOWING REAR KITS WILL BE USED IN CONJUNCTION WITH THIS BASE KIT:

57589	'86-'89 4-Runner with 2.5" Rear U-Bolts		
	'86-'95 Pickup w/ 2.5" Rear U-Bolts		
95-350	3 1/2" Rear tapered Blocks (9/16")	2	14
13-90126	9/16" U-bolts (2-1/2" Wide)	4	14
13-10423-Z	9/16" U-bolt Nut	8	14
13-30330-Z	9/16" U-bolts Washers	8	14
-OR-			
57789	'86-'89 4-Runner with 3.25" Rear U-Bolts		
	'86-'95 Pickup w/ 3.25" Rear U-Bolts		
20-830671-2	3 1/2" Rear Tapered Blocks (7/8" Pin)2	14	
13-90321	9/16" U-bolts (3.25" Wide)	4	14
13-10423-Z	9/16" U-bolt Nut	8	14
13-30330-Z	9/16" U-bolt Washers	8	14
-OR-			
57489	'90-'95 4-Runner		
90-1204	Lower Link Relocating Bracket	2	
90-1272	Upper Link Relocating Bracket	2	
90-2130	Bump Stop Extension	2	
90-1268	Trac Bar Relocating Bracket	1	
90-2133	Sway Bar Extension	2	
90-7210E	Brake Hose	1	
5242-1	Limiting Strap	2	

PLEASE NOTE: ON SOME V6 MODELS, A HIGH MISALIGNMENT DRIVESHAFT MAY BE REQUIRED IF THE ORIGINAL EQUIPMENT DRIVE-SHAFT BINDS AT THE CONSTANT VELOCITY JOINT AFTER THE LIFT KIT IS INSTALLED.

Introduction:

- ◆ **This installation requires a professional mechanic!**
- ◆ We recommend that you have access to a factory service manual for your vehicle to assist in the disassembly and reassembly of your vehicle. It contains a wealth of detailed information.
- ◆ Prior to installation, carefully inspect the vehicle's steering and driveline systems paying close attention to the tie rod ends, ball joints, wheel bearing preload, pitman and idler arm. Additionally, check steering-to-frame and suspension-to-frame attaching points for stress cracks. The overall vehicle must be in excellent working condition. Repair or replace all worn or damaged parts!
- ◆ Read the instructions carefully and study the illustrations before attempting installation! You may save yourself a lot of extra work.
- ◆ Check the parts and hardware against the parts list to assure that your kit is complete. Separating parts according to the areas where they will be used and placing the hardware with the brackets before you begin will save installation time.
- ◆ Check the special equipment list and ensure the availability of these tools.
- ◆ Secure and properly block vehicle prior to beginning installation.
- ◆ **ALWAYS** wear safety glasses when using power tools or working under the vehicle!
- ◆ Use caution when cutting is required under the vehicle. The factory undercoating is flammable. Take appropriate precautions. Have a fire extinguisher close at hand.
- ◆ Foot pound torque readings are listed on the Torque Specifications chart at the end of the instructions. These are to be used unless specifically directed otherwise. Apply thread lock retaining compound where specified.
- ◆ ***Please note that while every effort is made to ensure that the installation of your Pro Comp lift kit is a positive experience, variations in construction and assembly in the vehicle manufacturing process will virtually ensure that some parts may seem difficult to install. Additionally, the current trend in manufacturing of vehicles results in a frame that is highly flexible and may shift slightly on disassembly prior to installation. The use of pry bars and tapered punches for alignment is considered normal and usually does not indicate a faulty product. However, if you are uncertain about some aspect of the installation process, please feel free to call our tech support department at the number listed on the cover page. We do not recommend that you modify the Pro Comp parts in any way as this will void any warranty expressed or implied by the Pro Comp Suspension company.***

Please Note:

- Front end and head light realignment is necessary!
- Speedometer and ABS recalibration will be necessary if larger tires (10% more than stock diameter) are installed.
- Tire and wheel choice is crucial in assuring proper fit performance and the safety of your Pro Comp equipped vehicle. For this application a wheel not to exceed 8 in width with a maximum backspacing of 3.5 must be used. Diameter of wheel may be any of the following 3 choices, 15, 16, 17. Any other diameter, either smaller or larger, will not be endorsed as acceptable by Pro Comp Suspension and will void any and all warranties, written or implied. In addition, a quality tire of radial design, not to exceed 33" tall x 12.5 wide is recommended.

INSTRUCTIONS:

PLEASE NOTE:

- ⇒ This is a mechanical change of 4" in front, 3" in rear.
- ⇒ Front end alignment is needed after installation, set to factory specs.
- ⇒ Do not adjust torsion bars; leave at factory specs.

BEFORE YOU BEGIN:

- ⇒ Read the instructions and study the illustrations before attempting installation. Separating parts according to the areas where they will be used and placing the hardware with the brackets before you begin will save installation time.
- ⇒ Check the parts and hardware against the parts list to assure that your kit is complete.
- ⇒ Secure and properly block vehicle prior to beginning installation.
- ⇒ Always wear safety glasses when

using power tools.

FRONT:

- 1) Place floor jack under front axle and raise vehicle. Place jack stands under frame to support vehicle. Set emergency brake and block rear wheels, in front and behind tires. Remove front wheels.
- 2) Remove clip from front of brake line and bracket. Cut bracket to center of hole to remove brake line of bracket. Install new brake line drop down bracket to **OEM** bracket and put **3/8"** flat washer on top. Insert **3/8" x 1"** hex bolt through both brackets and tighten with **3/8"** nyloc nut on bottom. You may need to reform line slightly. Be sure not kink or cause any interference of line. Reinstall **OEM** brake line clip to hose at bracket. See ILLUSTRATION 1.
- 3) Remove the shocks, sway bar, and bump stops on each side (4 bump stops total). Remove eccentric bolt and nut front and rear. Remove front crossmember from mounting bracket. On passenger side only, cut the mounting bracket tabs off of the exist-

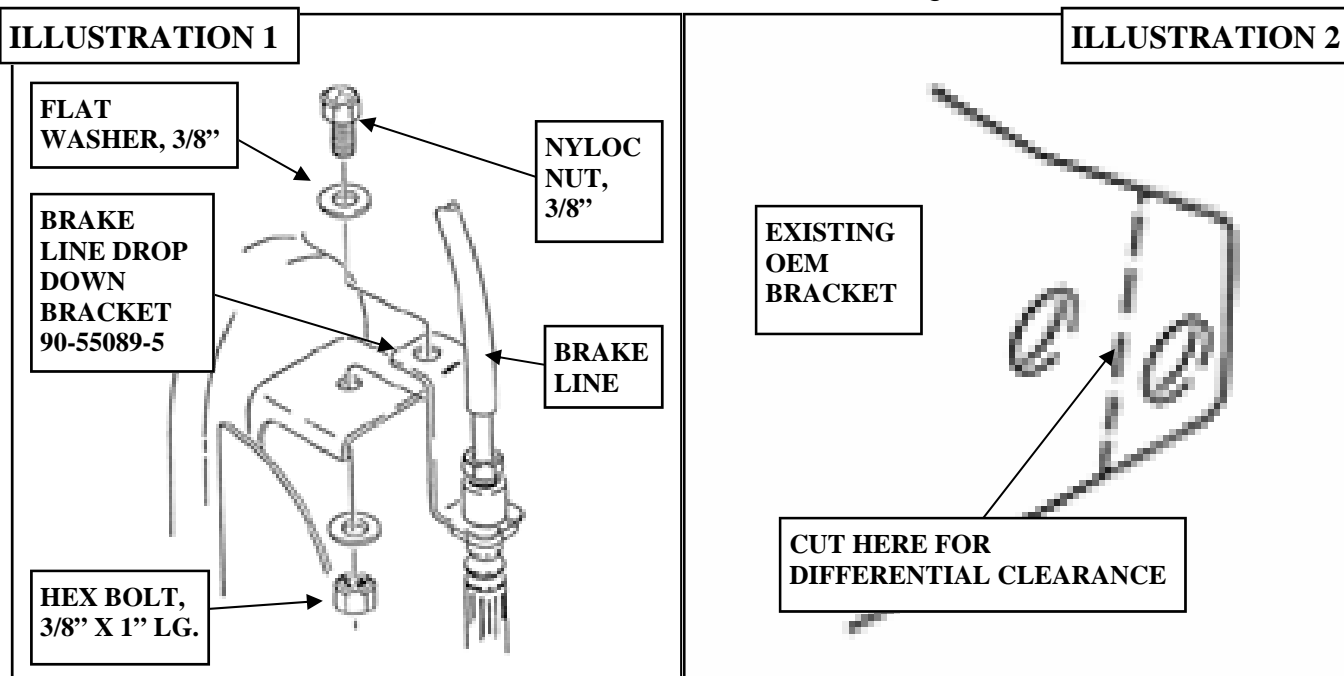

ILLUSTRATION 3

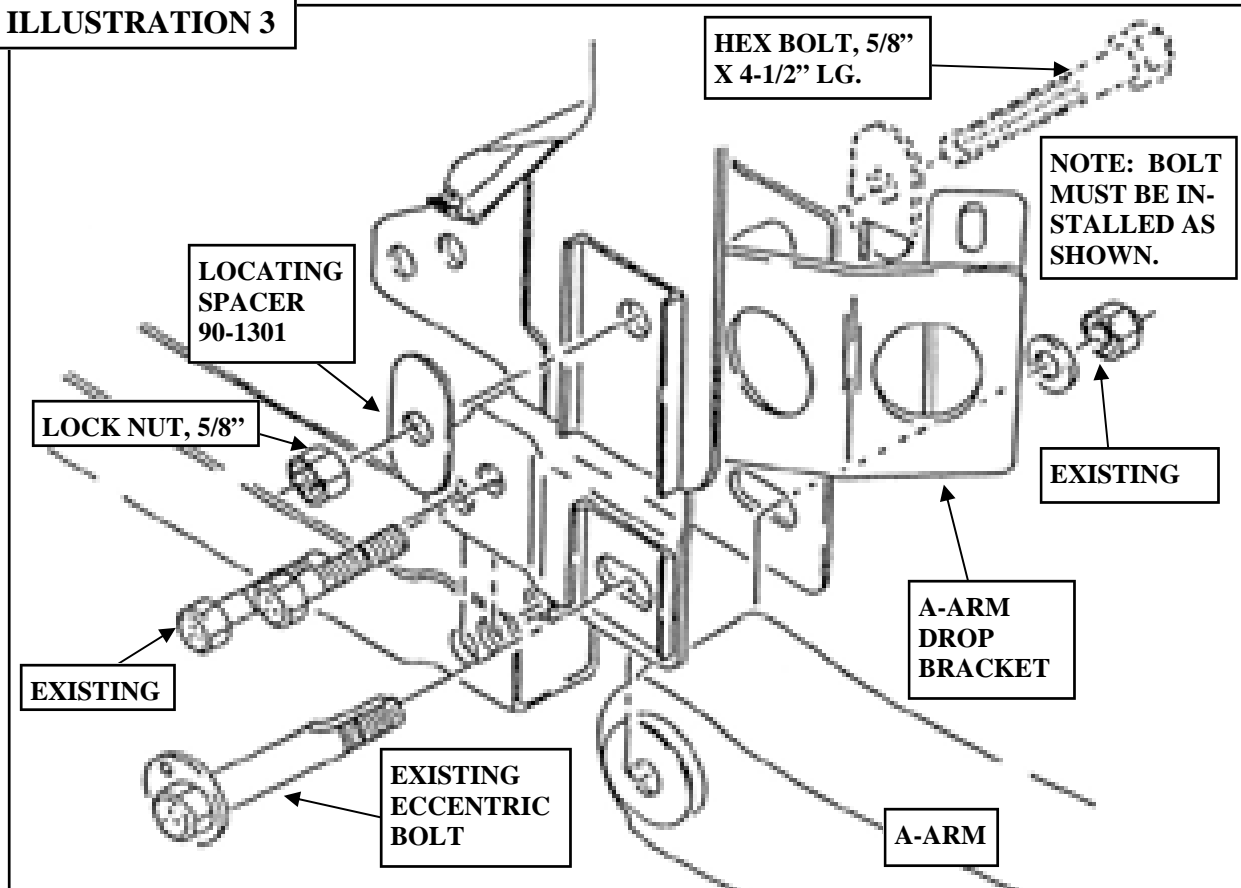
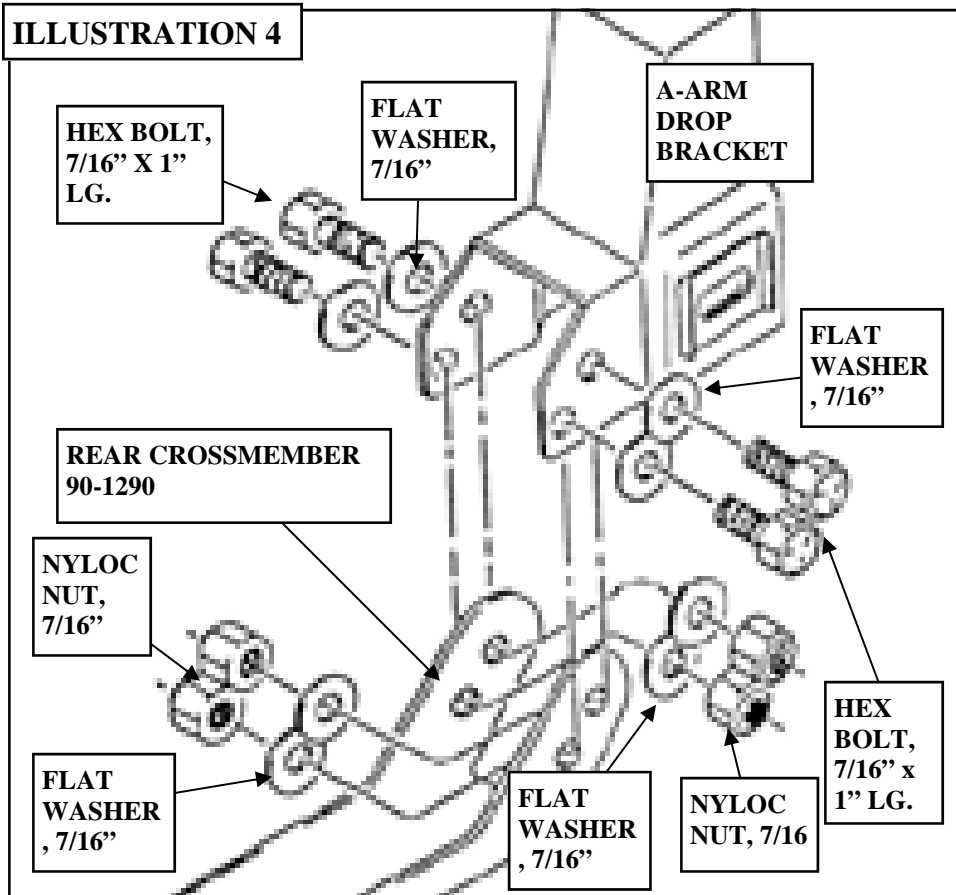

ILLUSTRATION 4



ing bracket between the bolt holes for differential clearance. See ILLUSTRATION 2.

4) Remove eccentric bolts (front and rear) on front lower a-arm.

5) Install the 4 a-arm drop brackets into OEM brackets. Use new **5/8" x 4-1/2"** hex bolts and **5/8"** lock nuts, placing the a-arm drop bracket locating spacers on the outside.

NOTE: Locating spacers will go in only one way and all 8 spacers are the same. Reinstall front crossmember with OEM bolts. Hand tighten bolts until brackets are aligned. See ILLUSTRATION 3.

6) Using a straight edge, line up bottom bracket tabs with upper **OEM** tabs. Then tighten bolts. Torque to 100 ft./lbs. (**Not crossmember bolts yet**). Install **OEM** bolts and nut into front crossmember to front differential. Tighten bolts and then tighten crossmember bolts.

7) Install new rear crossmember using **7/16" x 1"** bolts, **7/16"** flat washers and nyloc nuts. Torque to 45 ft./lbs. Using a straight edge, align upper tabs with lower tabs and tighten bolts. Torque to 100 ft./lbs. See ILLUSTRATION 4.

8) Install lower a-arms into lower a-arm brackets. Reinstall **OEM** eccentric bolts with hole in **OEM** cam washers at bottom. Install **OEM** nuts and tighten nuts. **NOTE: Tighten nut, not bolt because cam will not turn inside of tabs.** Torque to 103 ft./lbs. Refer back to ILLUSTRATION 3, if necessary.

9) Lower differential (keep steady so not to pull out front driveshaft). Install center differential bracket (**90-1277**) at rear of front differential as shown in ILLUSTRATION 5.

a) Install the **1/4"** spacer tube at rear lower mounting between differential and

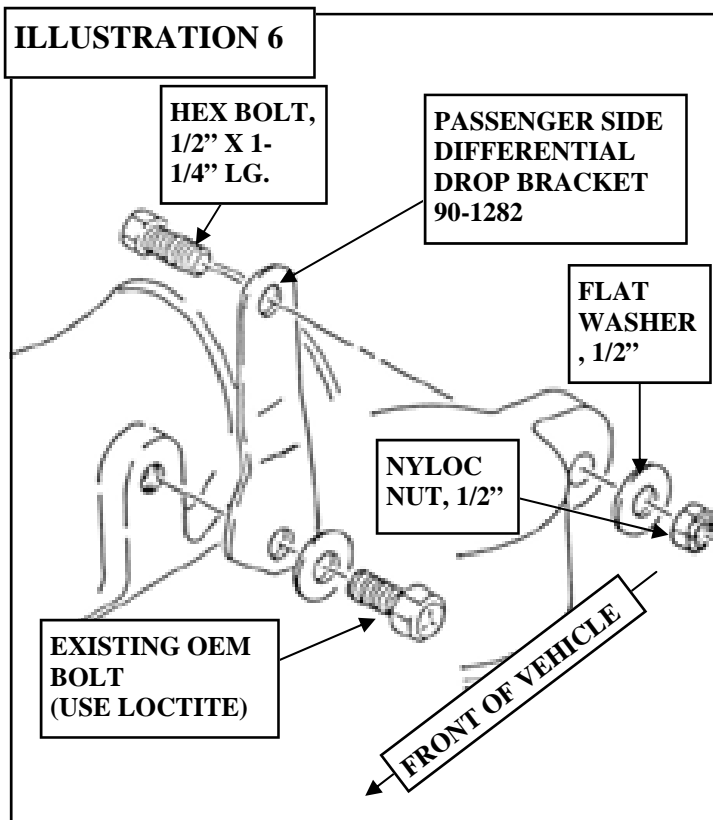
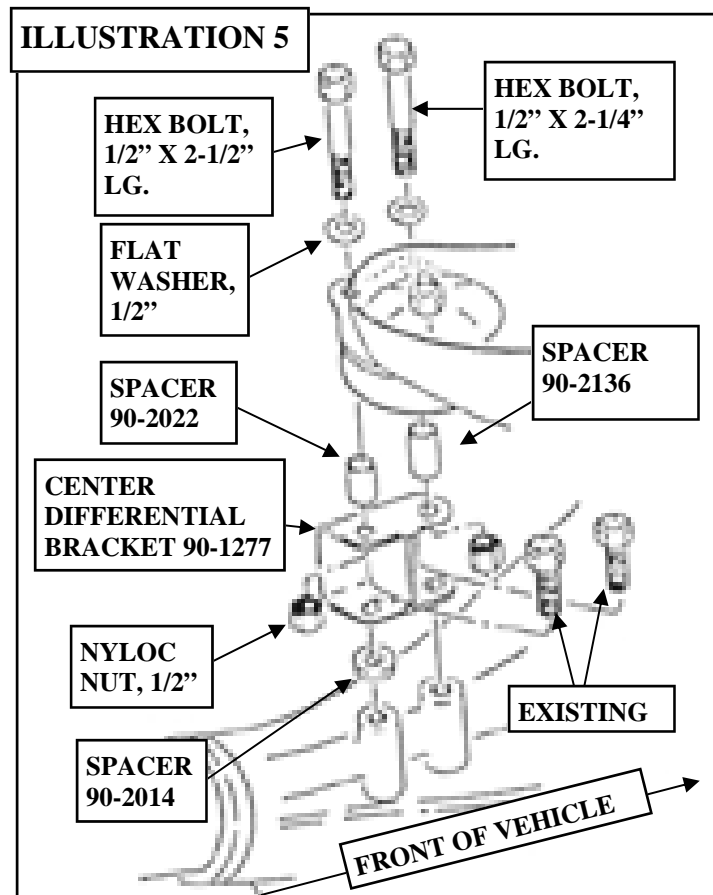

bracket. Install existing **OEM** bolts through bracket, spacer and into the two bottom holes (with loctite). Torque to 70 ft./lbs.

b) Install **1-1/8"** spacer tube at rear of upper **OEM** rubber mount with **1/2" x 2-1/2"** hex bolt, **1/2"** flat washer and **1/2"** nyloc nut. Torque to 70 ft./lbs.

c) Install **3/4"** spacer tube at rear of upper **OEM** rubber mount with **1/2" x 2-1/4"** bolt, **1/2"** flat washer and **1/2"** nyloc nut. Torque to 70 ft./lbs.

10) Install passenger side differential drop bracket using **1/2" x 1-1/4"** hex bolt with **1/2"** flat washer and nyloc nut into upper hole of **OEM** rubber mount. Wide part of bracket should be at bottom with hole towards front, as shown in ILLUSTRATION 6. Reinstall **OEM** bolt through bracket and into side of differential (using loctite). Torque to 70 ft./lbs.

11) Install driver side differential drop bracket using **OEM** bolts in two bottom holes (using loctite). Use **1/2" x 1-1/4"** hex bolts, **1/2"** flat washers and **1/2"** nyloc nuts in two upper holes. Torque to 70 ft./lbs. See ILLUSTRATION 7.

12) Remove tie rods from steering knuckles. Remove two bolts on back side of spindle which hold the metal bracket for the brake hose.

13) Support lower a-arm with floor jack and separate upper ball joint from spindle. Using file, file corners off of spindle to contour with bottom of new spindle adapter so that the bottom of the new spindle seat surface is in contour with **OEM** spindle top surface. Clean out hole on top of steering knuckle (spindle).

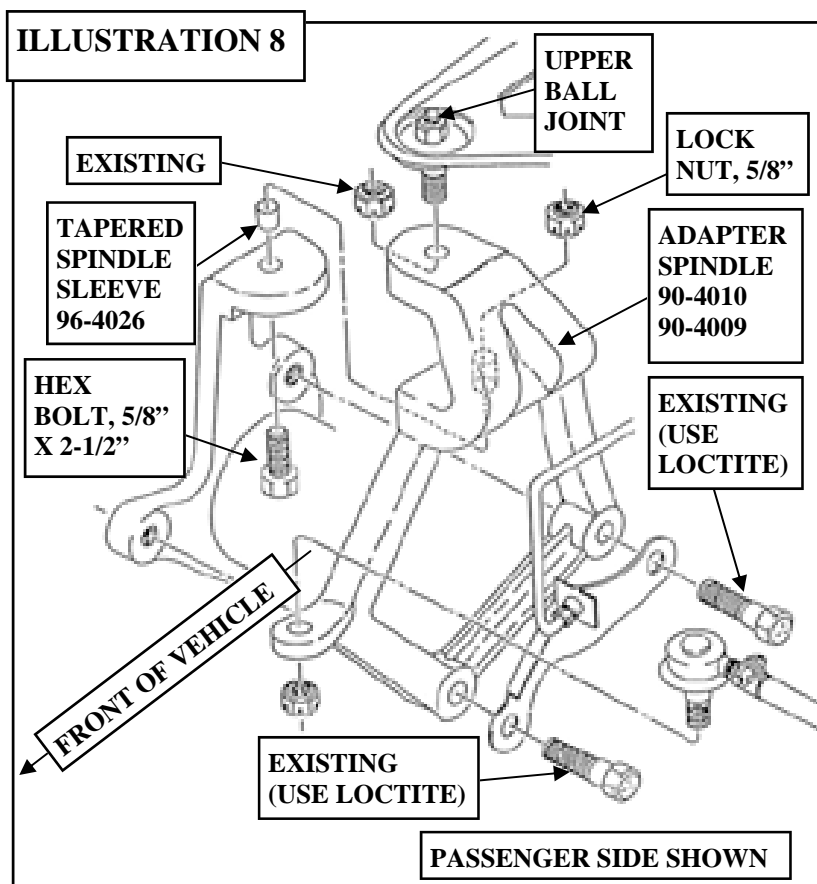
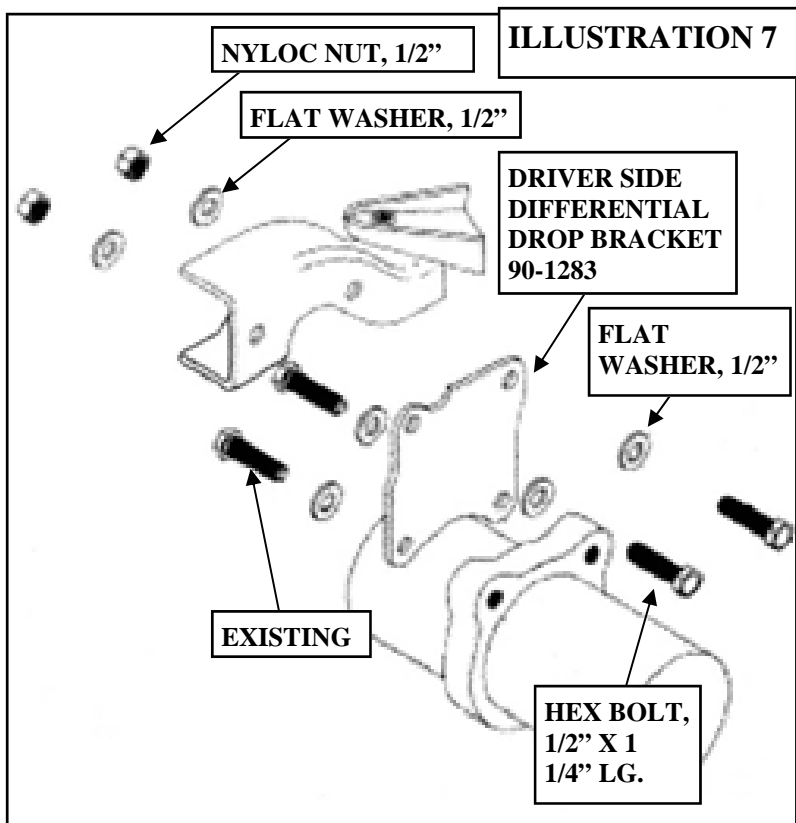

14) Insert tapered spindle sleeve with small end going downward, install **5/8" x 2-1/2"** hex bolt and **5/8"** lock nut as shown in ILLUSTRATION 8. Torque to 100 ft./lbs.

15) Referring again to ILLUSTRATION 8, reinstall brake hose bracket to new spindle with **OEM** bolts (using loctite). Torque to 120 ft./lbs. Insert spindle into upper ball joint; tighten. Torque to 105 ft./lbs. Reinstall the rod. Torque to 67 ft./lbs. Reinstall all cotter pins.

16) File down front bump stop lip on each side of front for shock clearance. Install new long shocks and tighten.

17) Install stock bump stop as shown in ILLUSTRATION 9 using the **3/8" x 1"** hex bolt, **3/8"** flat washer and **3/8"** nyloc nut. Repeat on other three bump stops.

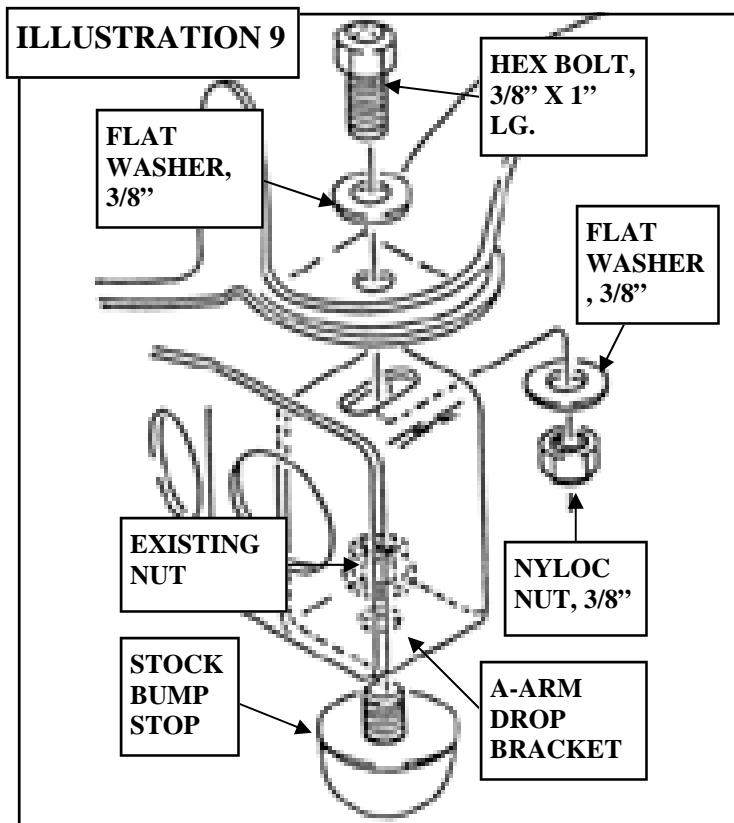

18) Reinstall sway bar with the two sway bar drop down brackets using **OEM** bolts and nuts in top holes, adding a **5/16"** flat washer to the **OEM** flat washers; tighten. Install sway bar to bottom of drop down bracket using **5/16" x 1"** hex bolts, **5/16"** flat washers and **5/16"** nyloc nuts; tighten. See ILLUSTRATION 10. (Driver side, use first forward round hole and rear slotted hole with slant downward, open side inward. Passenger side, use first slotted hole and rear round hole with slant downward, open side inward). Tighten sway bar bracket bolts and sway bar pins in a-arm.

19) Install lower end of the compression strut into the tabs located on the a-arm drop brackets using the bushings and hardware provided. Install the upper compression strut mount, as shown in ILLUSTRATION 11. Using existing hardware.

20) Install the front wheel and lower the vehicle.

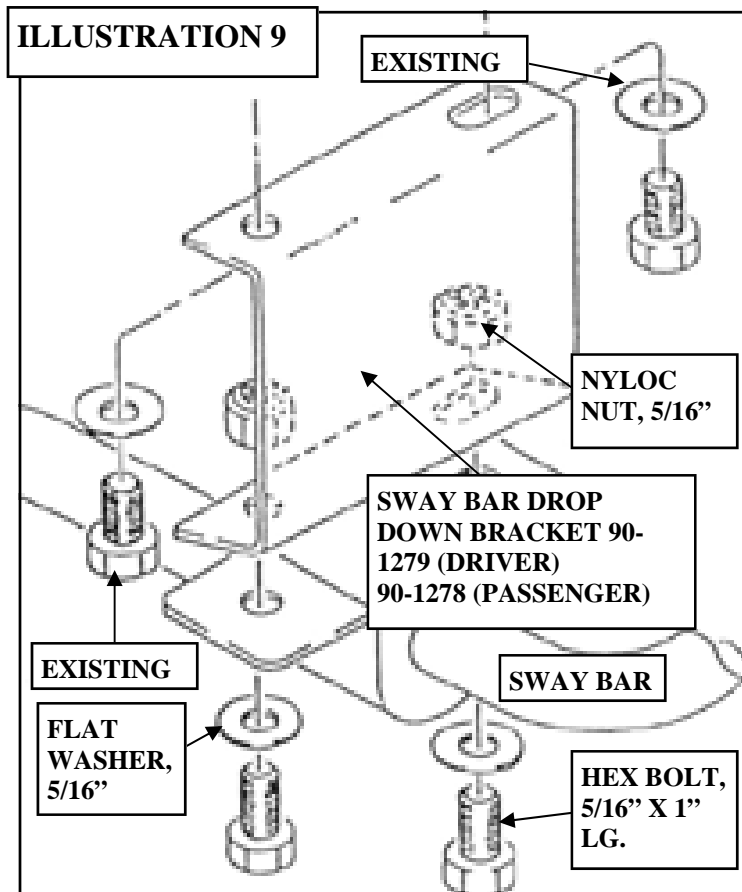
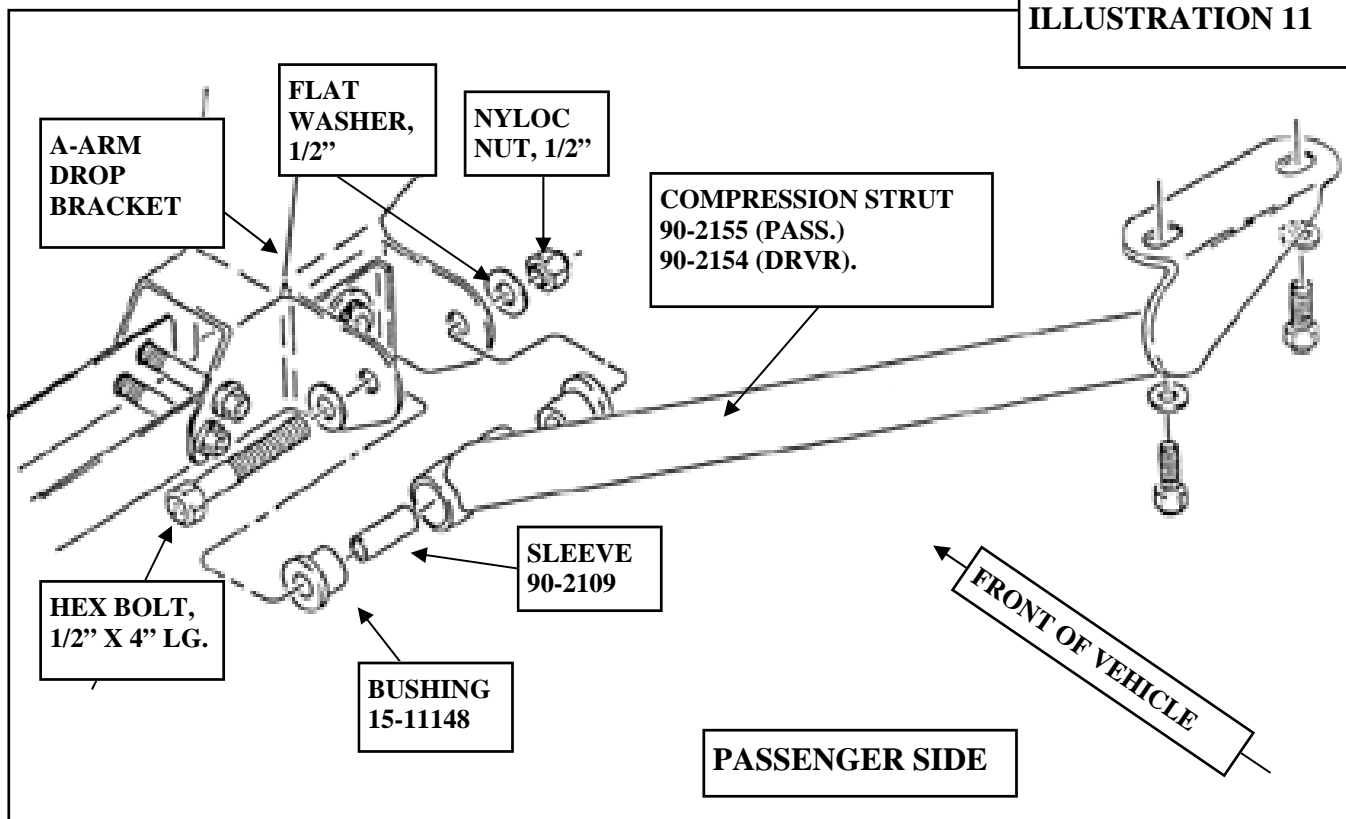

ILLUSTRATION 11



NOTE:

- ⇒ Measure from center of eccentric adjustment bolt to ground to ensure proper height.
- ⇒ On alignment, both sides inner and outer tie rods may need to be pulled out of adjusting sleeve and cut 1/2" off tie rod ends so proper adjustment can be achieved.
- ⇒ After installation is complete, double check that all nuts and bolts are tight. (Do not retighten nuts and bolts where loctite was used). Recheck periodically.

REAR INSTALLATION:

REAR: 86-89 4-Runner 86-95 Pickup

1) Place floor jack under rear axle and raise vehicle. Place jack stands under frame to support vehicle. Set emergency brake and block front wheels, in front and behind tires. Remove wheels and shocks.

2) Pull out brake line clip at rear brake hose bracket. Bolt rear brake line drop down bracket to existing bracket using $3/8''$ x $1''$ hex bolt, $3/8''$ flat washer and $3/8''$ nyloc nut; tighten. Install brake line into lower bracket hole and reinstall **OEM** brake line clip. Refer to ILLUSTRATION 12.

3) Unbolt brake equalizer arm bracket from axle. Install rear brake cable extension to axle with **OEM** bolts and tighten. Mount equalized cable bracket to top of extension using $5/16''$ x $1''$ hex bolts and $5/16''$ nyloc nuts and tighten. See ILLUSTRATION 13.

4) Loosen emergency cables by removing cotter pin, pulling pin out from back side of brake backing plate at adjuster.

5) Remove u-bolts, lower axle and install $3\ 1/2''$ tapered blocks with tapered end towards transmission, as shown in ILLUSTRATION 14. Install new u-bolts, washers and nuts and tighten. Reinstall emergency brake cable, keeping cable under spring.

6) Install new longer shock absorbers.

7) Install the rear wheels and lower the vehicle.

NOTE:

⇒ After installation is complete, double check that all nuts and bolts are tight. (Do not retighten nuts and bolts where loctite was used).

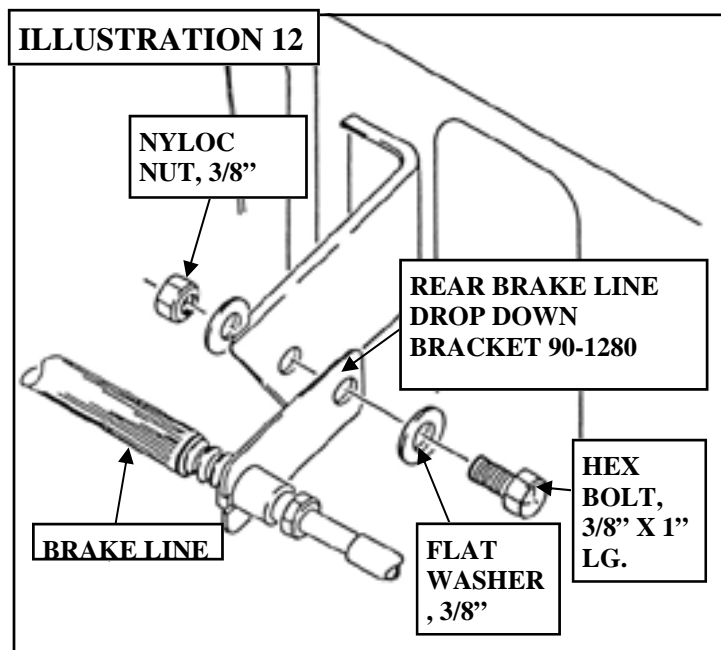

⇒ Recheck periodically.

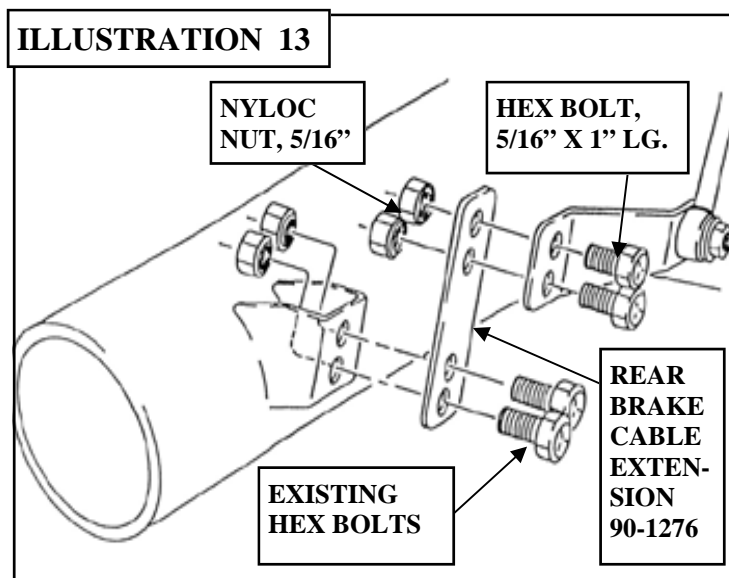

TORQUE SPECIFICATIONS:		Drvr. Differential Brkt. Bolt.....	70
A-Arm Drop Bracket Bolts.....	100	ft./lbs.	
ft./lbs.		Tapered Spindle Sleeve Bolt.....	100
Crossmember Bolts.....	45	ft./lbs.	
ft./lbs.		Brake Hose Brkt. to Spindle.....	120
Eccentric Bolts.....	103	ft./lbs.	
ft./lbs.		Spindle to Upper Ball Joint.....	105
Center Differential Bolts.....	70	ft./lbs.	
ft./lbs.		Tie Rod.....	67
Pass. Differential Brkt. Bolt.....	70	ft./lbs.	
ft./lbs.		U-Bolts.....	100 ft./lbs.

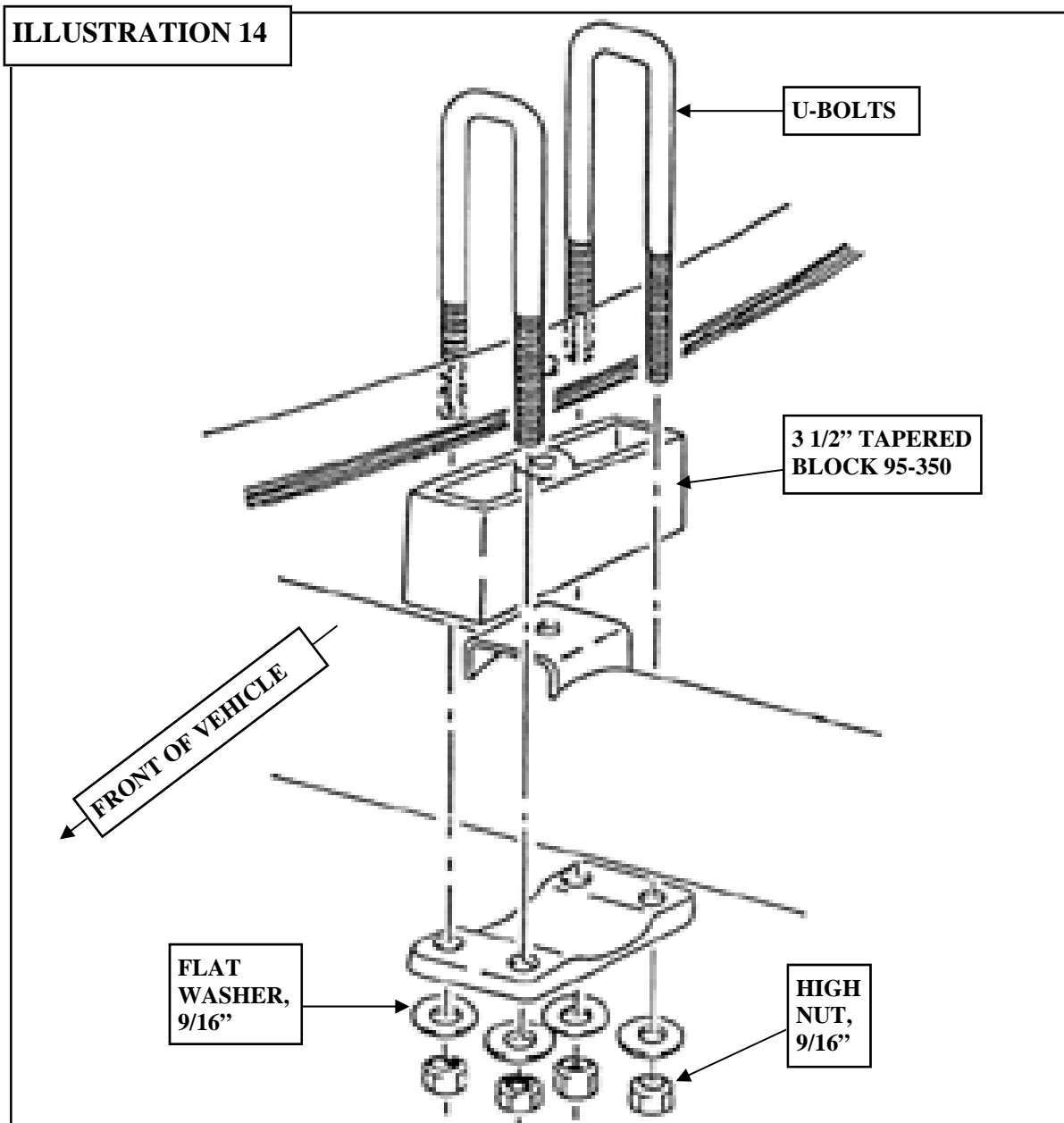

Use this only as a guide for hardware without a called out torque specification in the instruction manual.

Bolt Torque and ID						
Decimal System			Metric System			
All Torques in Ft. Lbs. Maximums						
Bolt Size	Grade 5	Grade 8	Bolt Size	Class 9.8	Class 10.9	Class 12.9
5/16	15	20	M6	5	9	12
3/8	30	45	M8	18	23	27
7/16	45	60	M10	32	45	50
1/2	65	90	M12	55	75	90
9/16	95	130	M14	85	120	145
5/8	135	175	M16	130	165	210
3/4	185	280	M18	170	240	290

1/2-13x1.75 HHCS **Grade 5 Grade 8**
 (No. of Marks + 2)

D T L X

G = Grade (Bolt Strength)
 D = Nominal Diameter (Inches)
 T = Thread Count (Threads per Inch)
 L = Length (Inches)
 X = Description (Hex Head Cap Screw)

M12-1.25x50 HHCS

D T L X

P = Property Class (Bolt Strength)
 D = Nominal Diameter (Millimeters)
 T = Thread Pitch (Thread Width, mm)
 L = Length (Millimeters)
 X = Description (Hex Head Cap Screw)

Notice to Owner operator, Dealer and Installer:

Vehicles that have been enhanced for off-road performance often have unique handling characteristics due to the higher center of gravity and larger tires. This vehicle may handle, react and stop differently than many passenger cars or unmodified vehicles, both on and off-road. You must drive your vehicle safely! Extreme care should always be taken to prevent vehicle rollover or loss of control, which can result in serious injury or even death. Always avoid sudden sharp turns or abrupt maneuvers and allow more time and distance for braking! Pro Comp reminds you to fasten your seat belts at all times and reduce speed! We will gladly answer any questions concerning the design, function, maintenance and correct use of our products.

Please make sure your Dealer/Installer explains and delivers all warning notices, warranty forms and instruction sheets included with Pro Comp product.

Application listings in this catalog have been carefully fit checked for each model and year denoted. However, Pro Comp reserves the right to update as necessary, without notice, and will not be held responsible for misprints, changes or variations made by vehicle manufacturers. Please call when in question regarding new model year, vehicles not listed by specific body or chassis styles or vehicles not originally distributed in the USA.

Please note that certain mechanical aspects of any suspension lift product may accelerate ordinary wear of original equipment components. Further, installation of certain Pro Comp products may void the vehicle’s factory warranty as it pertains to certain covered parts; it is the consumer’s responsibility to check with their local dealer for warranty coverage before installation of the lift.

Warranty and Return policy:

Pro Comp warrants its full line of products to be free from defects in workmanship and materials. Pro Comp’s obligation under this warranty is limited to repair or replacement, at Pro Comp’s option, of the defective product. Any and all costs of removal, installation, freight or incidental or consequential damages are expressly excluded from this warranty. Pro Comp is not responsible for damages and / or warranty of other vehicle parts related or non-related to the installation of Pro Comp product. A consumer who makes the decision to modify his vehicle with aftermarket components of any kind will assume all risk and responsibility for potential damages incurred as a result of their chosen modifications. Warranty coverage does not include consumer opinions regarding ride comfort, fitment and design. Warranty claims can be made directly with Pro Comp or at any factory authorized Pro Comp dealer.

IMPORTANT! To validate the warranty on this purchase please be sure to mail in the warranty card.

Claims not covered under warranty-

- Parts subject to normal wear, this includes bushings, bump stops, ball joints, tie rod ends and heim joints
 - Discontinued products at Pro Comp’s discretion
- Bent or dented product
- Finish after 90 days
- Leaf or coil springs used without proper bump stops
- Light bulbs
- Products with evident damage caused by abrasion or contact with other items
- Damage caused as a result of not following recommendations or requirements called out in the installation manuals
- Products used in applications other than listed in Pro Comp’s catalog
- Components or accessories used in conjunction with other manufacturer’s systems
- Tire & Wheel Warranty as per Pro Competition Tire Company policy
- Warranty claims without “Proof of Purchase”
- Pro Comp Pro Runner coil over shocks are considered a serviceable shock with a one-year warranty against leakage only. Rebuild service and replacement parts will be available and sold separately by Pro Comp. Contact Pro Comp for specific service charges.
- Pro Comp accepts no responsibility for any altered product, improper installation, lack of or improper maintenance, or improper use of our products.

E-Mail: tech@explorerprocomp.com
Website: www.explorerprocomp.com
Fax: (619) 216-1474
Ph: (619) 216-1444

PLACE
WARRANTY REGISTRATION
NUMBER
HERE: _____

2360 Boswell Road
Chula Vista, CA 91914
Phone 619.216.1444
Fax 619.216.1474
E-Mail tech@explorerprocomp.com



PRO COMP SUSPENSION

Suspension Systems that Work!

**Part # 57489
1990 - 1995
Toyota 4 Runner
Rear
Suspension Kit**

This document contains very important information that includes warranty information and instructions for resolving problems you may encounter. Please keep it in the vehicle as a permanent record.

Part #	Description	Qty.	Illus.	Page
90-1204	Lower Link Relocating Bracket	2	2	5
90-1272	Upper Link Relocating Bracket	2	1	5
90-2130	Bump Stop Extension	2	2	5
90-1268	Trac Bar Relocating Bracket	1	3	6
90-2133	Sway Bar Extension	2	5	7
90-7210E	Brake Hose	1		
5242-1	Limiting Strap	2	6	7
90-6106	Hardware Pack Containing:			
90-1274	Proportioning Valve Bracket	1	7	8
90-1273	Reinforcement Strap	4	1	5
90-2132	Lower Link Bracket Spacer	2	1	5
90-1275	1-1/2" O.D. Washer	4	1	5
51792	Hour Glass Bushing Sleeve	2	4	6
45359	Hour Glass Bushing	2	4	6
90-6103	Hardware Pack Containing:			
70-0431251500	7/16"x1-1/4 USS Gd. 5 Hex Bolt	5	2,6	5,7
70-0431001500	7/16"x1 USS Gd. 5 Hex Bolt	4	1	5
70-0501001500	1/2"x1 USS Gd. 4 Hex Bolt	2	5	7
70-0502501500	1/2"x2-1/2 USS Gd. 5 Hex Bolt	2	4	6
70-0623001500	5/8"x3 USS Gd. 5 Hex Bolt	1	6	7
70-0624001500	5/8"x4 USS Gd. 5 Hex Bolt	4	1	5
70-0624501500	5/8"x4-1/2 USS Gd. 5 Hex Bolt	4	2	5
72-05000100512	1/2" USS Nyloc Nut	4	4,5	6,7
72-04300100512	7/16" USS Nyloc Nut	9	1,2,6	5,7
72-06200100512	5/8" USS Nyloc Nut	9	4	6
73-04300032	7/16 SAE Flat Washer	8	2	5
73-05000032	1/2 SAE Flat Washer	8	4	6
73-06200032	5/8 SAE Flat Washer	18		
90-6104	Hardware Pack Containing:			
70-0803012508800	8mm-1.25 x 30mm Bolt	2		
70-0812012508800	8mm-1.25 x 120mm Bolt	2		
72-00812508812	8mm-1.25 Nyloc Nut	2		
73-00800036	8mm Split Lock Washer	2		
		1		

Part # 57490 COIL SPRING KIT will be used in conjunction with this kit. It contains:

57489-1	Coil Spring	2	2	5
---------	-------------	---	---	---

Introduction:

- ◆ **This installation requires a professional mechanic!**
- ◆ We recommend that you have access to a factory service manual for your vehicle to assist in the disassembly and reassembly of your vehicle. It contains a wealth of detailed information.
- ◆ Prior to installation, carefully inspect the vehicle's steering and driveline systems paying close attention to the tie rod ends, ball joints, wheel bearing preload, pitman and idler arm. Additionally, check steering-to-frame and suspension-to-frame attaching points for stress cracks. The overall vehicle must be in excellent working condition. Repair or replace all worn or damaged parts!
- ◆ Read the instructions carefully and study the illustrations before attempting installation! You may save yourself a lot of extra work.
- ◆ Check the parts and hardware against the parts list to assure that your kit is complete. Separating parts according to the areas where they will be used and placing the hardware with the brackets before you begin will save installation time.
- ◆ Check the special equipment list and ensure the availability of these tools.
- ◆ Secure and properly block vehicle prior to beginning installation.
- ◆ **ALWAYS** wear safety glasses when using power tools or working under the vehicle!
- ◆ Use caution when cutting is required under the vehicle. The factory undercoating is flammable. Take appropriate precautions. Have a fire extinguisher close at hand.
- ◆ Foot pound torque readings are listed on the Torque Specifications chart at the end of the instructions. These are to be used unless specifically directed otherwise. Apply thread lock retaining compound where specified.
- ◆ ***Please note that while every effort is made to ensure that the installation of your Pro Comp lift kit is a positive experience, variations in construction and assembly in the vehicle manufacturing process will virtually ensure that some parts may seem difficult to install. Additionally, the current trend in manufacturing of vehicles results in a frame that is highly flexible and may shift slightly on disassembly prior to installation. The use of pry bars and tapered punches for alignment is considered normal and usually does not indicate a faulty product. However, if you are uncertain about some aspect of the installation process, please feel free to call our tech support department at the number listed on the cover page. We do not recommend that you modify the Pro Comp parts in any way as this will void any warranty expressed or implied by the Pro Comp Suspension company.***

Please Note:

- Front end and head light realignment is necessary!
- Speedometer and ABS recalibration will be necessary if larger tires (10% more than stock diameter) are installed.

INSTRUCTIONS:

BEFORE YOU BEGIN:

- ⇒ **Read the instructions and study the illustrations before attempting installation.**
- ⇒ **Check the parts and hardware against the parts list to assure that your kit is complete.**
- ⇒ **Separate the parts according to the area where they will be used. Placing the hardware with the parts before you begin will save installation time.**
- ⇒ **Secure and properly block vehicle prior to beginning installation.**
- ⇒ **Always wear safety glasses when using power tools.**

SPECIAL NOTE:

Be sure your vehicle is in good working condition; repair and replace worn parts. Pay special attention to the steering and driveline systems including the tie rod/drag link ends, ball joints and wheel bearing preload. Also check for stress in areas where steering and suspension attach to frame.

IN PREPARATION FOR INSTALLATION OF THIS KIT:

- 1) Place floor jack under differential and raise vehicle. Place jack stands under frame to support vehicle. Lower the frame onto the stands, keeping some tension on the floor jack.
- 2) Detach the **LSPV** shackle from the driver's side of the trac bar. Secure the shackle up and out of the way.
- 3) Remove the brake hose, detaching the upper end first. Install the new hose by attaching the lower end first. The upper retaining clip prongs will need to be spread slightly to fit the new hose. You will be instructed on how to bleed the brake system later.

- 4) Remove the shocks.
- 5) Remove the anti-sway bar links that connect the sway bar from to the frame rails. Some of the existing rubber bushings and hardware will be used to install new sway bar extension. See ILLUSTRATION 4.
- 6) Disconnect the upper end of the trac bar from the passenger side mount. Leave the driver side end of the trac bar attached. Let the trac bar hang.
- 7) Disconnect the upper and lower 4-link rods from the differential. Detach the rubber grommets which hold the parking brake cables, from the lower links. The cables will stay free.

At this time, place another floor jack directly under the pinion, where the drive shaft connects to the axle.

- 8) Disconnect the ends of the lower 4-link rods from the frame rails.
- 9) Using the floor jacks, lower the rear axle enough to enable you to remove the coil springs. Remove the bolts that secure the bump stops to the coil seats. (Inside the coils).

INSTALLATION:

- 1) Install the upper link relocating brackets, **1-1/2"** O.D. washers and reinforcement washers using the **7/16"** hardware as shown in ILLUSTRATION 1. Put a **5/8" x 4"** bolt through the top hole in the existing bracket with a **5/8"** nut; tighten. Put a **5/8" x 4"** bolt through the top hole of the relocating bracket and the rod eye; do not tighten yet. Repeat this procedure on the other side.
- 2) Referring to ILLUSTRATION 2, install the lower link relocating bracket (**90-1204**) and the lower link bracket spacer (**90-2132**) using the supplied **5/8" x 4 1/2"** bolt and **5/8"** lock nut; do not tighten yet. Drill two (**2**) **7/16"** holes through the frame rails at the existing holes in the lower link relocating bracket. Install the supplied **7/16"**

ILLUSTRATION 1

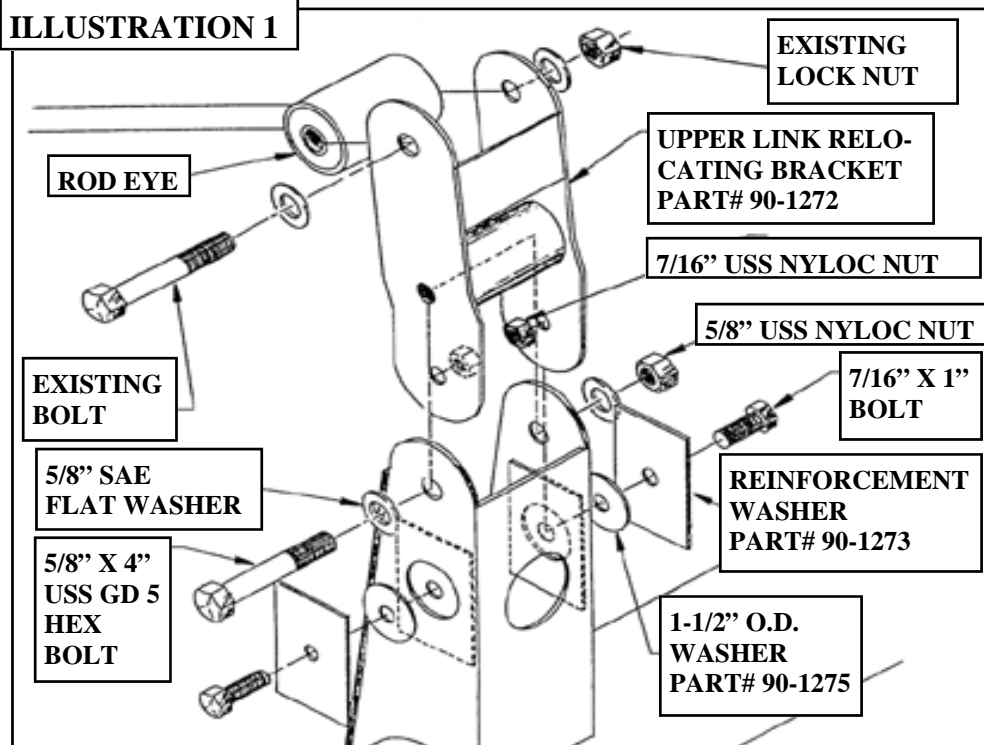
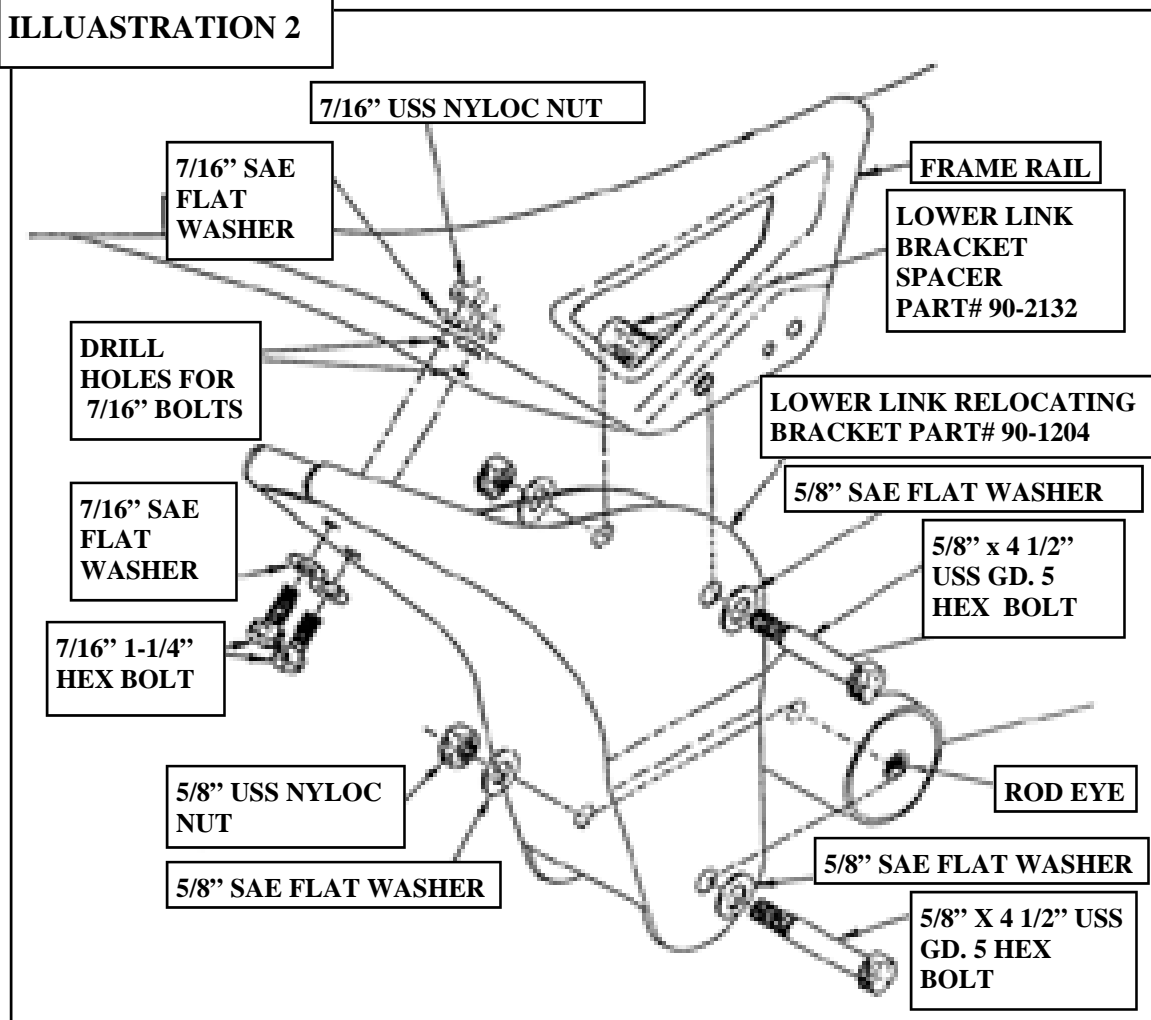
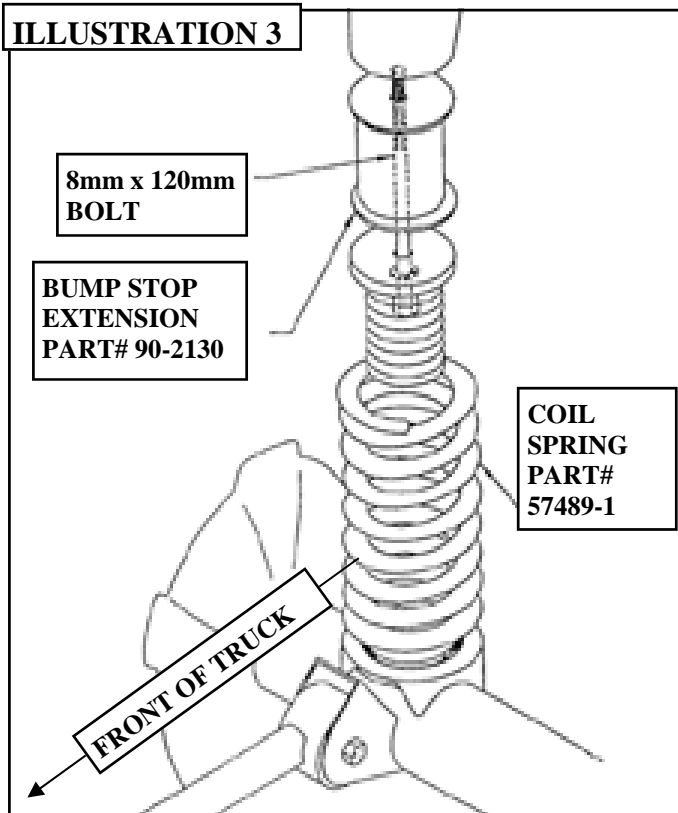

ILLUSTRATION 2





x 1-1/4" bolts, 7/16" washers and lock nuts. Now tighten the 5/8" bolt.

Still referring to ILLUSTRATION 2, attach the lower link relocating bracket to the trac bar rod eye using the supplied 5/8" x 4-1/2" bolt and 5/8" lock nut; do not tighten yet. Repeat these procedures on the other side.

3) Reposition the floor jacks so that one is under each axle tube. Install the bump stop extensions (90-2130) between the existing bumps stops and the stock mounts using the supplied 8mm x 120mm bolts and 8mm lock washers. See ILLUSTRATION 3. Install the new coil springs. Raise the jacks to keep a slight load on the springs.

4) Install the new sway bar extension (90-2133) utilizing the existing rubber bushings and hardware where the extensions mount to the vehicle frame. See ILLUSTRATION 4. Install the hour glass bushing (45359) and the hour glass bushing sleeve (51792) into the bushing housing and attach to the sway bar using the supplied 1/2" hardware.

The next step will be to bleed the brake system. It will take two (2) people to complete this procedure.

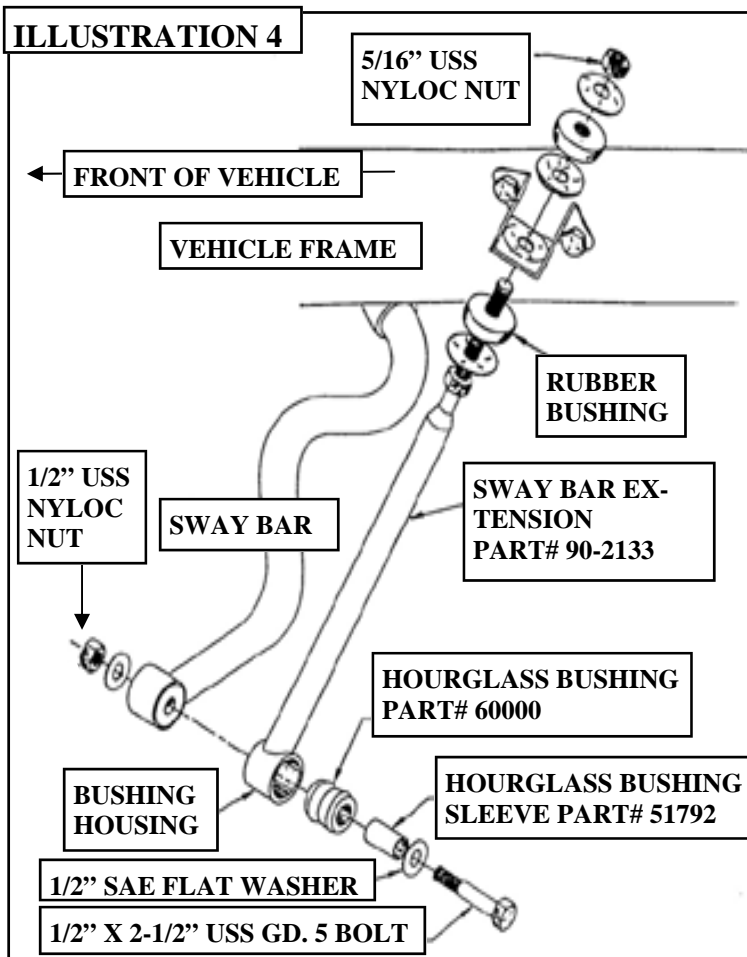

⇒ **Fill the master cylinder with approved brake fluid.**

⇒ **Pump up, then hold pressure on the pedal. Open up the wheel cylinder bleeder nut to purge air from the system. Close the bleeder nut when the pedal reaches the floor. Continue the bleeding process until only fluid (no air) is discharged. Bleed each wheel and replenish master cylinder after each process.**

⇒ **With all the air out of the system, the brake pedal should not pump-up or have excessive down-travel.**

⇒ **Bleed the proportioning valve, using this same procedure. The valve is located at the frame rail on the passenger side.**

⇒ **Double check all fitting for leaks.**

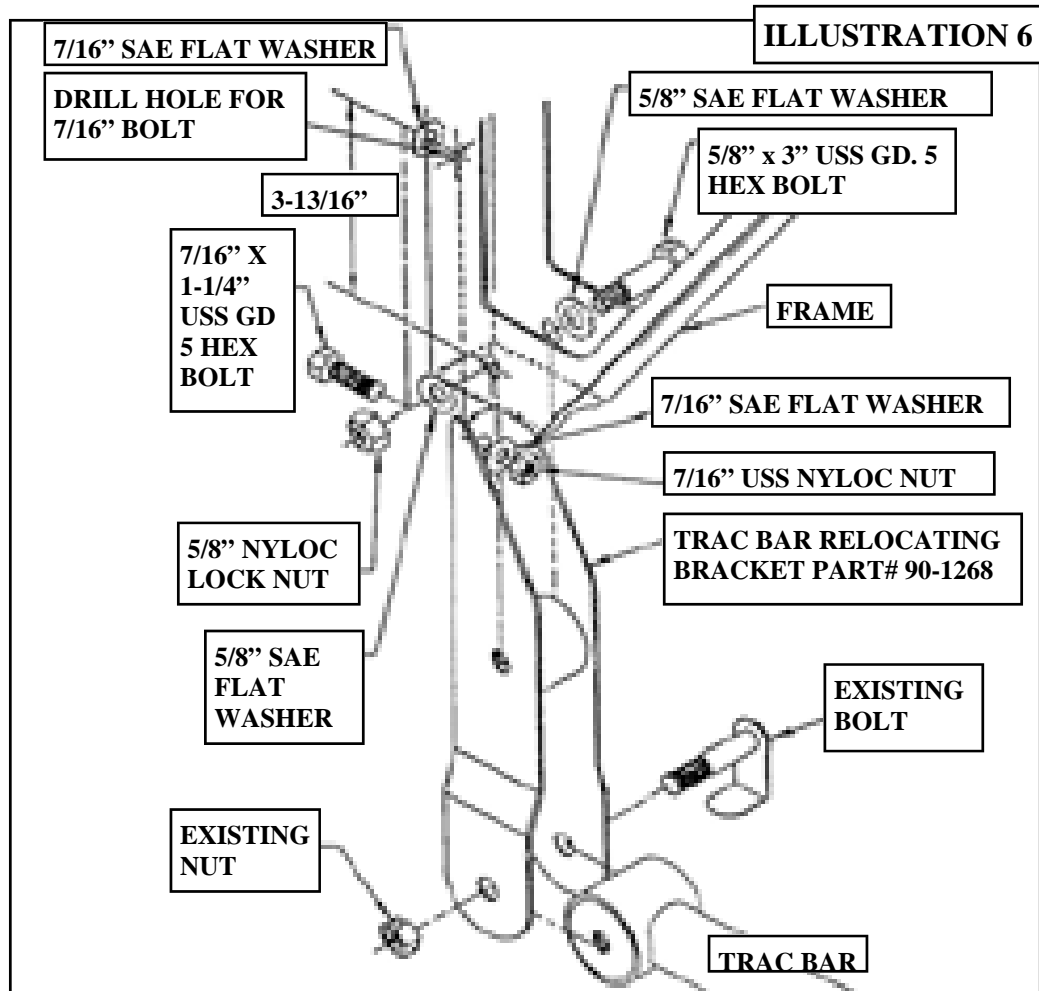
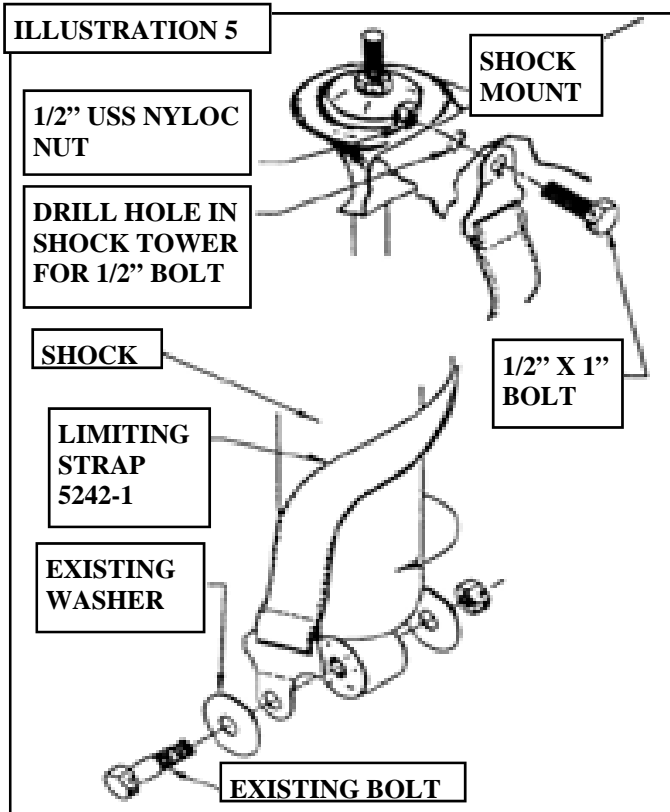

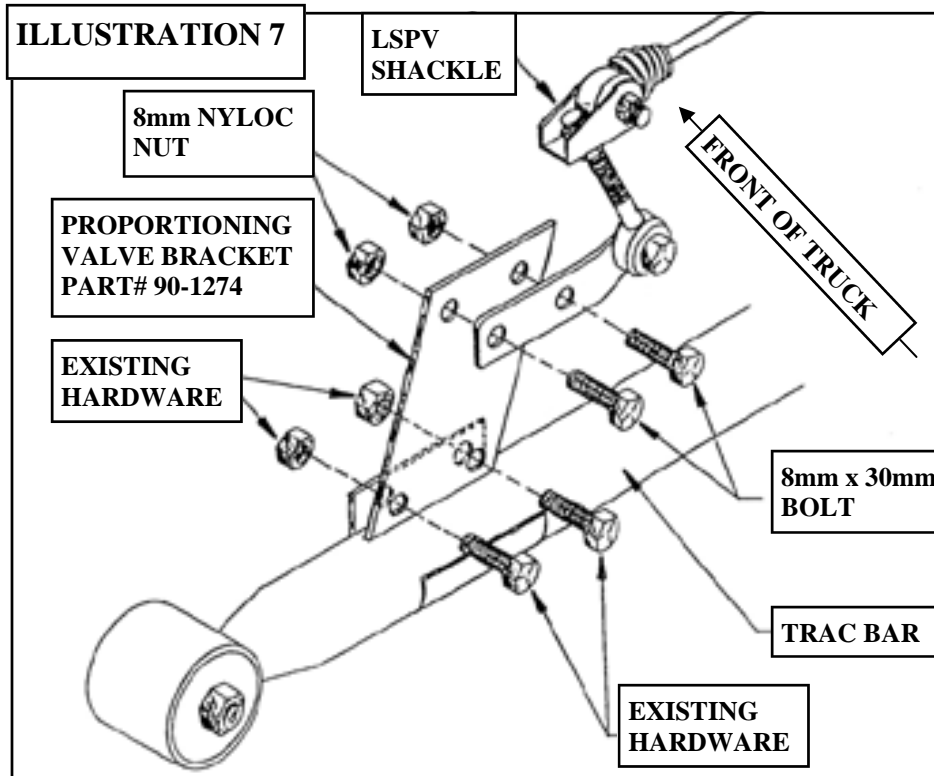

5) Reinstall the shocks. Drill a hole in the shock tower, as shown in ILLUSTRATION 5, and install the upper end of the limiting strap (5242-1) using the supplied 1/2" hardware. Bolt the bottom end of the limiting strap to the shock using the existing hardware as shown in the illustration.

NOTE: The mounting brackets offset should face away from the attaching points to gain clearance.

At this point, install the wheels and lower the vehicle. Manually bounce the vehicle to stabilize the suspension.

With the suspension supporting the vehicle's weight, tighten the four 4-link rod eye bolts.

6) Install the trac bar relocating bracket (90-1268) to stock position on frame, as shown in ILLUSTRATION 6, using the supplied 5/8" hardware; do not tighten yet. Install the bottom holes of the trac bar relocating bracket to the trac bar using the existing hardware. Prior to drilling the 7/16" hole, center the body over tires. It may be necessary to shift the body slightly to the left or right. Install and tighten the 7/16" hardware to secure the upper end, then tighten and torque the 5/8" bolt and existing bolt.

7) Install the proportioning valve bracket (90-1274) as shown in ILLUSTRATION 7, using the supplied 8mm hardware in the upper holes and the existing hardware in the lower holes where bracket mount to trac bar).

As the suspension settles the LSPV rod activates the LSPV. This increases rear wheel braking force accordingly. The relocating bracket keeps the rod properly positioned in relation to the LSPV. Therefore, it is recommended that the LSPV system be inspected and adjusted by your Toyota dealer.

RECHECK THE FASTENERS FOR PROPER TIGHTNESS. SEE TORQUE SPECIFICATION CHART.

TORQUE SPECIFICATIONS:

5/16" Bolts.....	13' lbs.
8mm Bolts.....	19' lbs.
7/16" Bolts.....	37' lbs.
1/2" Bolts.....	70' lbs.
5/8" Bolts.....	112' lbs.
Existing Bolts.....	101' lbs.

Use this only as a guide for hardware without a called out torque specification in the instruction manual.

Bolt Torque and ID						
Decimal System			Metric System			
All Torques in Ft. Lbs. Maximums						
Bolt Size	Grade 5	Grade 8	Bolt Size	Class 9.8	Class 10.9	Class 12.9
5/16	15	20	M6	5	9	12
3/8	30	45	M8	18	23	27
7/16	45	60	M10	32	45	50
1/2	65	90	M12	55	75	90
9/16	95	130	M14	85	120	145
5/8	135	175	M16	130	165	210
3/4	185	280	M18	170	240	290

1/2-13x1.75 HHCS Grade 5 Grade 8
 (No. of Marks + 2)

D T L X

G = Grade (Bolt Strength)
 D = Nominal Diameter (Inches)
 T = Thread Count (Threads per Inch)
 L = Length (Inches)
 X = Description (Hex Head Cap Screw)

M12-1.25x50 HHCS

D T L X

P = Property Class (Bolt Strength)
 D = Nominal Diameter (Millimeters)
 T = Thread Pitch (Thread Width, mm)
 L = Length (Millimeters)
 X = Description (Hex Head Cap Screw)

Notice to Owner operator, Dealer and Installer:

Vehicles that have been enhanced for off-road performance often have unique handling characteristics due to the higher center of gravity and larger tires. This vehicle may handle, react and stop differently than many passenger cars or unmodified vehicles, both on and off-road. You must drive your vehicle safely! Extreme care should always be taken to prevent vehicle rollover or loss of control, which can result in serious injury or even death. Always avoid sudden sharp turns or abrupt maneuvers and allow more time and distance for braking! Pro Comp reminds you to fasten your seat belts at all times and reduce speed! We will gladly answer any questions concerning the design, function, maintenance and correct use of our products.

Please make sure your Dealer/Installer explains and delivers all warning notices, warranty forms and instruction sheets included with Pro Comp product.

Application listings in this catalog have been carefully fit checked for each model and year denoted. However, Pro Comp reserves the right to update as necessary, without notice, and will not be held responsible for misprints, changes or variations made by vehicle manufacturers. Please call when in question regarding new model year, vehicles not listed by specific body or chassis styles or vehicles not originally distributed in the USA.

Please note that certain mechanical aspects of any suspension lift product may accelerate ordinary wear of original equipment components. Further, installation of certain Pro Comp products may void the vehicle’s factory warranty as it pertains to certain covered parts; it is the consumer’s responsibility to check with their local dealer for warranty coverage before installation of the lift.

Warranty and Return policy:

Pro Comp warrants its full line of products to be free from defects in workmanship and materials. Pro Comp’s obligation under this warranty is limited to repair or replacement, at Pro Comp’s option, of the defective product. Any and all costs of removal, installation, freight or incidental or consequential damages are expressly excluded from this warranty. Pro Comp is not responsible for damages and / or warranty of other vehicle parts related or non-related to the installation of Pro Comp product. A consumer who makes the decision to modify his vehicle with aftermarket components of any kind will assume all risk and responsibility for potential damages incurred as a result of their chosen modifications. Warranty coverage does not include consumer opinions regarding ride comfort, fitment and design. Warranty claims can be made directly with Pro Comp or at any factory authorized Pro Comp dealer.

IMPORTANT! To validate the warranty on this purchase please be sure to mail in the warranty card.

Claims not covered under warranty-

- Parts subject to normal wear, this includes bushings, bump stops, ball joints, tie rod ends and heim joints
 - Discontinued products at Pro Comp’s discretion
- Bent or dented product
- Finish after 90 days
- Leaf or coil springs used without proper bump stops
- Light bulbs
- Products with evident damage caused by abrasion or contact with other items
- Damage caused as a result of not following recommendations or requirements called out in the installation manuals
- Products used in applications other than listed in Pro Comp’s catalog
- Components or accessories used in conjunction with other manufacturer’s systems
- Tire & Wheel Warranty as per Pro Competition Tire Company policy
- Warranty claims without “Proof of Purchase”
- Pro Comp Pro Runner coil over shocks are considered a serviceable shock with a one-year warranty against leakage only. Rebuild service and replacement parts will be available and sold separately by Pro Comp. Contact Pro Comp for specific service charges.
- Pro Comp accepts no responsibility for any altered product, improper installation, lack of or improper maintenance, or improper use of our products.

E-Mail: tech@explorerprocomp.com
Website: www.explorerprocomp.com
Fax: (619) 216-1474
Ph: (619) 216-1444

<u>PLACE</u>
<u>WARRANTY REGISTRATION</u>
<u>NUMBER</u>
<u>HERE:</u> _____