

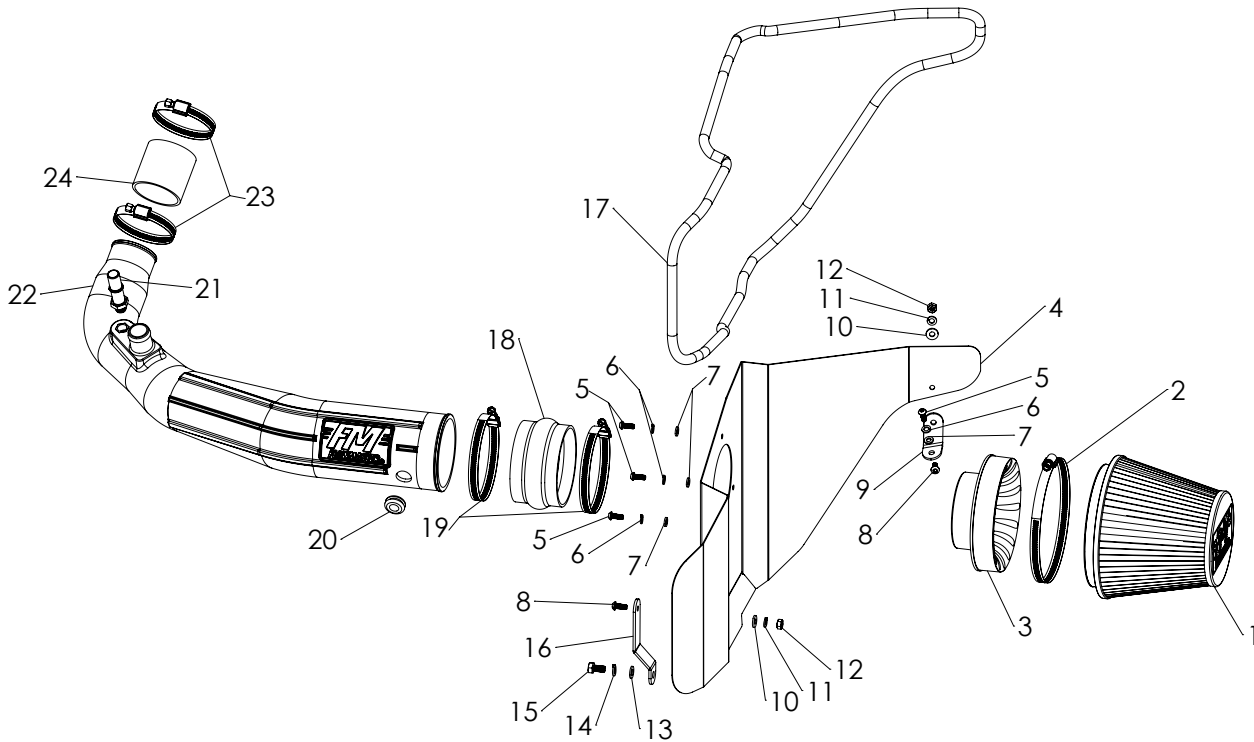

# Installation Instructions for: SYSTEM # 615160 2015-2017 FORD MUSTANG w/2.3L Turbo

NOT LEGAL FOR SALE OR USE ON ANY POLLUTION-CONTROLLED MOTOR VEHICLE IN CALIFORNIA OR IN STATES THAT HAVE ADOPTED CALIFORNIA EMISSION PROCEDURES.



REV. 11/01/17

ITEM NO.	PART NUMBER	DESCRIPTION	QTY.
1	AF1003	AIR FILTER, 6-5/8" x 6" DIA	1
2		SCREW CLAMP, #104 (4-1/8" - 7")	1
3	AF6002	ADAPTER, AIR FILTER 4" x 6"	1
4	AF3041	HEAT SHIELD, 15-17, MUSTANG, 2.3T	1
5	HW244	SCREW, M6 x 1.0 x 16MM	4
6	HW318	LOCK WASHER, M6	4
7	HW319	FLAT WASHER, M6	4
8	HW245	SCREW, 1/4"-20 x 5/8"	2
9	AF5009	BRACKET 1, 15-17 FORD MUSTANG 2.3T	1
10	HW320	FLAT WASHER, 1/4"	2
11	HW322	LOCK WASHER, 1/4"	2
12	HW115	NUT, 1/4"-20	2

ITEM NO.	PART NUMBER	DESCRIPTION	QTY.
13	HW324	FLAT WASHER, M8	1
14	HW323	LOCK WASHER, M8	1
15	HW249	BOLT, M8 x 1.25 x 16MM	1
16	AF5043	BRACKET 2, 15-17 FORD MUSTANG 2.3T	1
17	49000061	GASKET, HEAT SHIELD	72"
18	AF4051	COUPLER, FLEX 4" I.D. x 2-1/2" L	1
19	MC400H	SCREW CLAMP, #64 (3-9/16" - 4-1/2")	2
20	AF4008	GROMMET, 1-1/16" OD x 1/2" ID x 3/16" THK	1
21	AF4016	FITTING, STRAIGHT 5/8" QC TO 1/4" NPT MALE	1
22	AF2041	INTAKE TUBE, 15-17, MUSTANG, 2.3T	1
23	MC250H	SCREW CLAMP, #44 (2-1/4" - 3-1/4")	2
24	AF4035	COUPLER, STRAIGHT 2-3/8" I.D. x 2-1/2" L	1

## REVIEW THE INSTRUCTIONS AND VERIFY THE KIT CONTENTS:

1. Please take a moment to read and understand these instructions before installing your Flowmaster cold air intake kit.



2. Use the parts drawing and list (front page) to verify your kit's contents.

In the unlikely event that any parts are missing, please contact Flowmaster Technical Support for replacements.

To simplify assembly and avoid cross-threading fasteners, identify and separate the 1/4-20 screws (item 8) (used with nuts (12)), and the M6 screws (5) (used with filter adapter (3)).

## REMOVE THE FACTORY AIR INTAKE SYSTEM:

### NOTES

- We highly recommend that you retain all factory air intake system parts.
- Please refer to vehicle manufacturer's recommendations regarding removal of factory components.
- Disconnecting the negative battery cable erases pre-programmed electronic memories. Write down all memory settings before disconnecting the negative battery cable. Some radios will require an anti-theft code to be entered after the battery is reconnected. The anti-theft code is typically supplied with your owner's manual. In the event your vehicle's anti-theft code cannot be recovered, contact an authorized dealership to obtain your vehicle's anti-theft code.

3. Turn off the vehicle's ignition and disconnect the negative battery cable.

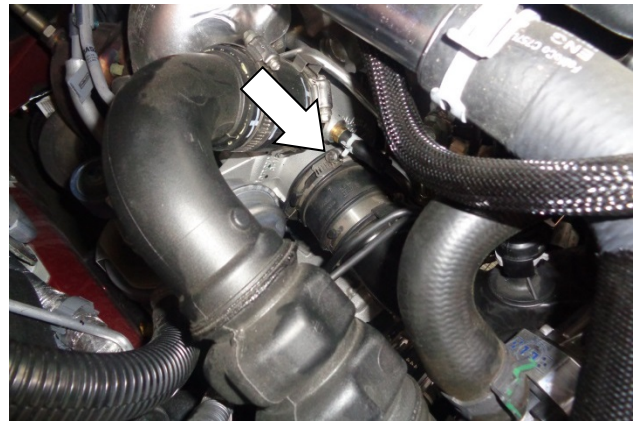

4. Loosen the screw clamp securing the intake duct to the turbocharger inlet.



5. Squeeze the pinch clamp on the diverter valve hose and separate the hose from the intake duct.



6. Disconnect the PCV line from the intake duct by releasing the locking tab and pulling the line straight off.



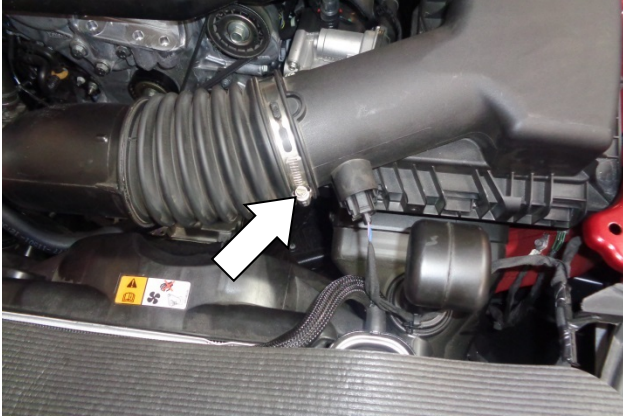

7. Loosen the screw clamp securing the intake duct to the airbox.



8. Separate the intake duct from the airbox and remove the duct from the vehicle.

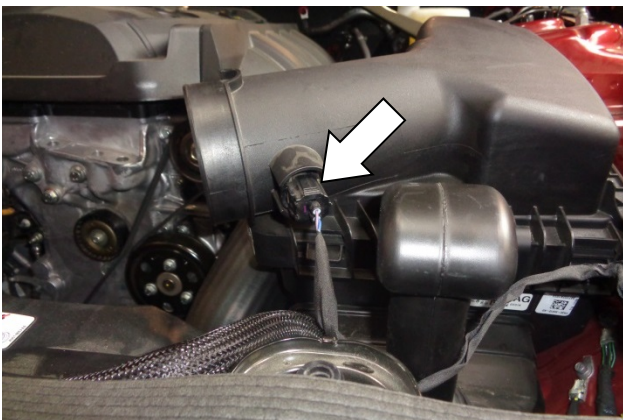

9. Disconnect the inlet air temperature sensor plug by squeezing the plug and pulling it straight off the sensor.



10. Remove the air temp sensor from the intake duct by lifting the locking tab and turning the sensor a quarter-turn counter-clockwise. Then remove the o-ring from the sensor. **CAUTION: The sensor is delicate!** Handle it with care, and store it in a safe location until reinstallation.

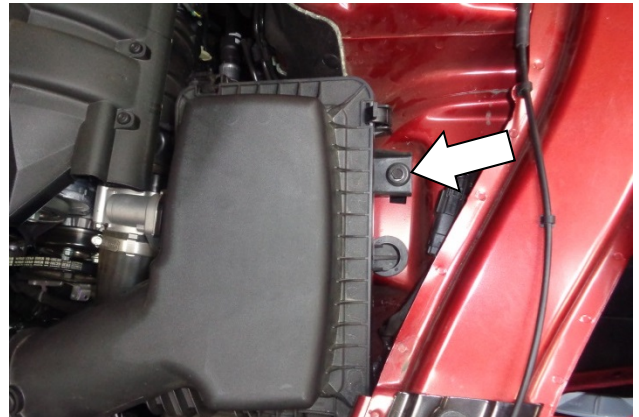

11. Remove the airbox mount bolt.



12. Remove the airbox from the vehicle.



**ASSEMBLE AND INSTALL YOUR FLOWMASTER COLD AIR INTAKE SYSTEM:**

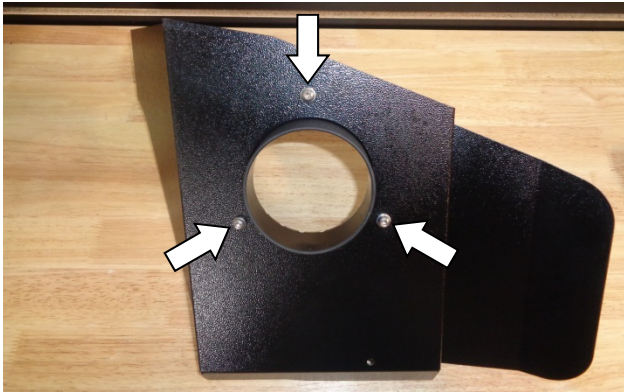

13. Assemble the air filter adapter (3) to the heat shield (4) using the M6 screws (5), lock washers (6) and flat washers (7).



14. Attach bracket (9) to the heat shield using a 1/4-20 screw (8) (against the bracket), and a flat washer (10), lock washer (11) and nut (12) (against the heat shield). **Do not tighten the bracket fasteners at this time.**



15. Attach bracket (16) to the heat shield using a 1/4-20 screw (8) (against the bracket), and a flat washer (10), lock washer (11) and nut (12) (against the heat shield). **Do not tighten the bracket fasteners at this time.**

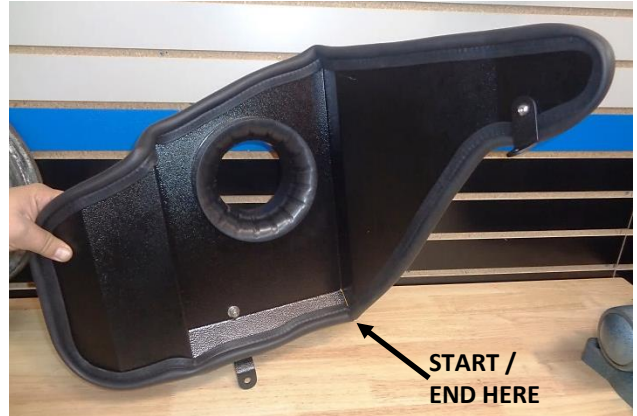

16. Starting at the corner shown, firmly press the gasket (17) onto the heat shield, gradually working your way around. When you return to the starting point, use metal-cutting shears to trim the gasket to length.



17. At the upper rear bracket, install and tighten the M6 screw (5), lock washer (6) and flat washer (7).



18. At the lower front bracket (A), install and tighten the M8 bolt (15), lock washer (14) and flat washer (13). Then tighten the fasteners (B) holding each bracket to the heat shield.





19. Apply 2 wraps of nylon thread tape to the threads of the 5/8" quick connect fitting (21), and install it in the intake tube (22).



20. Install the rubber grommet (20) in the intake tube. Carefully insert the air temp sensor into the grommet, so that the tab points toward the tube opening. (NOTE: Moisten the components with soapy water to ease assembly.)



21. Install the small screw clamps (23) on the small coupler (24). Install the coupler on the small end of the tube. Snug (but do not yet tighten) just the clamp on the tube.



22. Install two large screw clamps (19) on the large coupler (18). Install the coupler on the large end of the tube. Snug (but do not yet tighten) just the clamp on the tube.



23. Install the intake tube in the vehicle. Do not tighten any screw clamps at this time.



24. Connect the PCV line to the quick connect fitting, rotating the intake tube as necessary to align them. Verify that the connection is secure.





25. Push the large coupler flush up against the heat shield. Tighten only the clamp on the filter adapter.

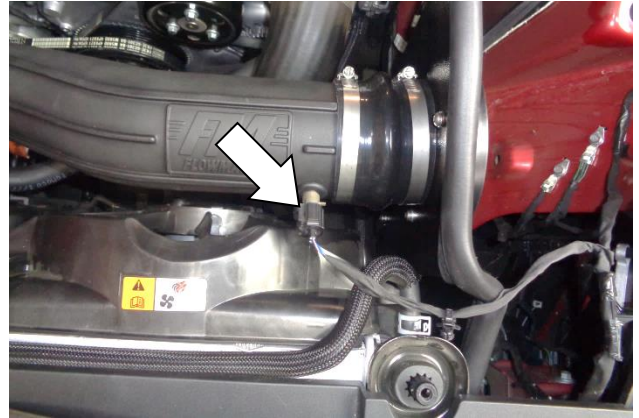

28. Plug the air temp sensor lead into the sensor until it clicks, then verify the connection is secure.

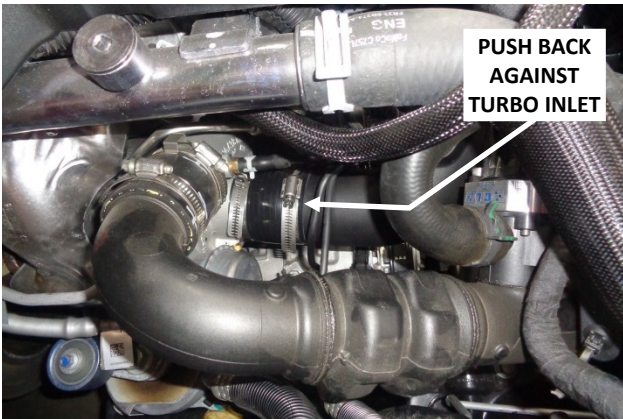

26. Push the small coupler back against the turbo inlet, and tighten the turbo inlet clamp. Finally, tighten the clamps at each end of the intake tube.

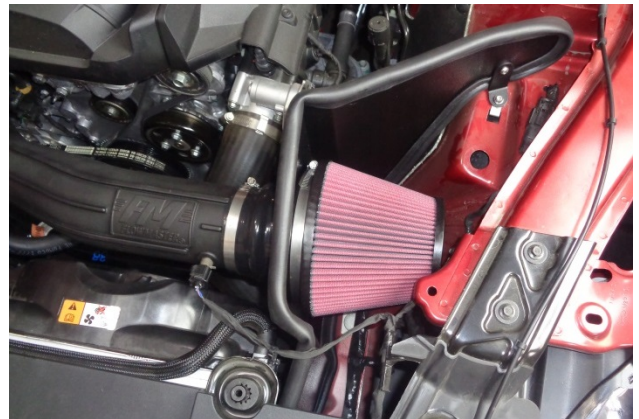

29. Install the clamp (2) on the air filter (1), then install the filter on the filter adapter and tighten the clamp.



27. Push the diverter valve hose into the intake tube and secure it with the pinch clamp.



**Congratulations! The installation of your new Flowmaster cold air intake kit is now complete!**