

READ ME ! ⚠

Thank you for purchasing our Drawer Dividers.

Before you start, take a moment to familiarize yourself with the Fitting Instructions and the components received.

Refer to Page 2 for a list of all the components, quantities and tools required.

IMPORTANT WARNING! ⚠

IT IS CRITICAL THAT ALL FRONT RUNNER PRODUCTS BE PROPERLY AND SECURELY ASSEMBLED AND ATTACHED TO YOUR VEHICLE. IMPROPER ATTACHMENT COULD RESULT IN AN AUTOMOBILE ACCIDENT, AND COULD CAUSE SERIOUS BODILY INJURY OR DEATH. YOU ARE RESPONSIBLE FOR ASSEMBLING AND SECURING ALL FRONT RUNNER PRODUCTS TO YOUR VEHICLE. CHECKING THE ATTACHMENTS PRIOR TO USE, AND PERIODICALLY INSPECTING THE PRODUCTS FOR ADJUSTMENT, WEAR AND DAMAGE. THEREFORE YOU MUST READ AND UNDERSTAND ALL OF THE INSTRUCTIONS AND PRECAUTIONS SUPPLIED WITH YOUR FRONT RUNNER PRODUCT PRIOR TO INSTALLATION OR USE. IF YOU DO NOT UNDERSTAND ALL OF THE INSTRUCTIONS AND CAUTIONS, OR IF YOU HAVE NO MECHANICAL EXPERIENCE AND ARE NOT THOROUGHLY FAMILIAR WITH THE INSTALLATION PROCEDURES, YOU SHOULD HAVE THE PRODUCT INSTALLED BY A PROFESSIONAL INSTALLER OR OTHER QUALIFIED PERSONNEL.

1 GET ORGANIZED

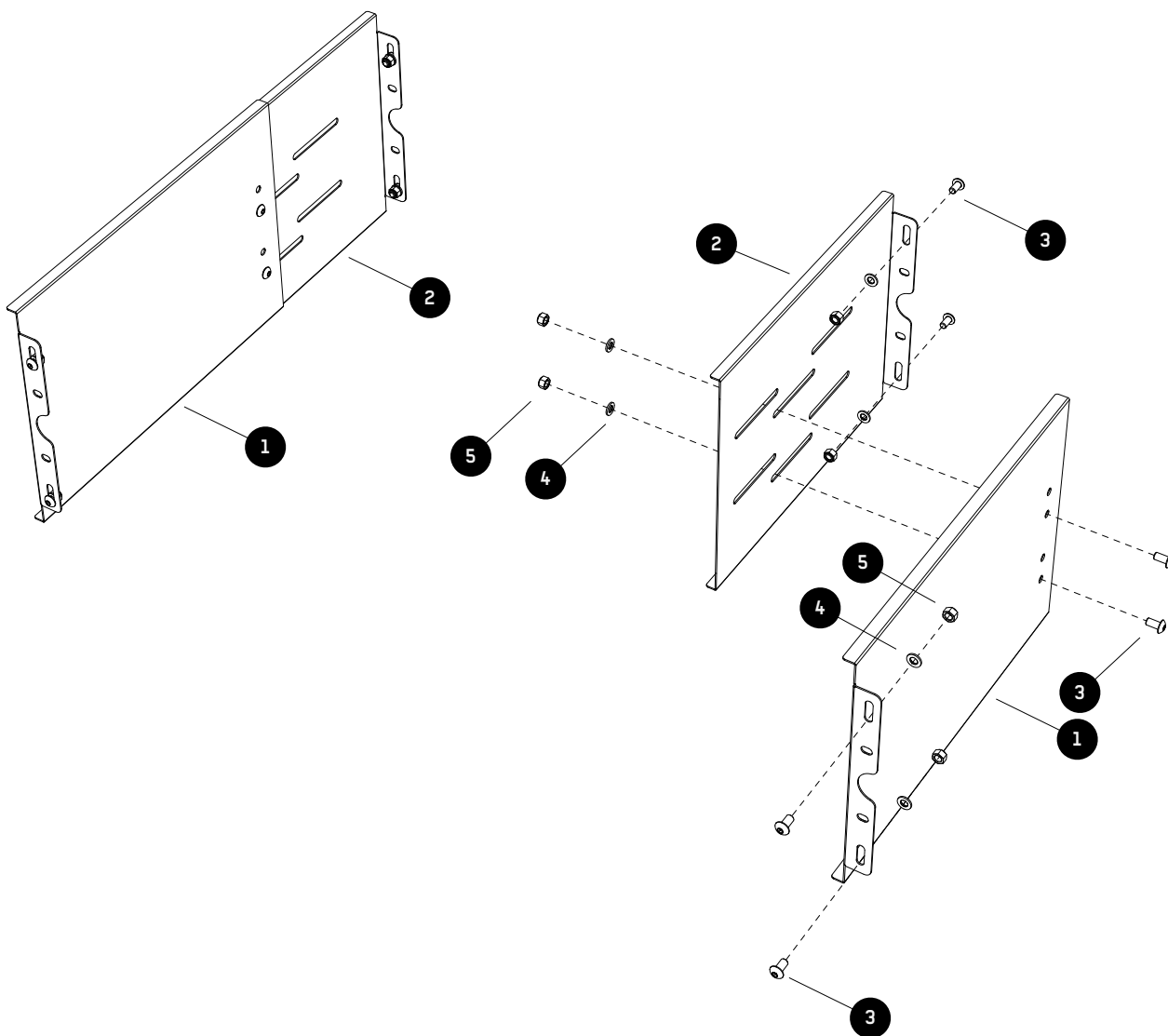
IN THE BOX

1	2 X	Divider Plate A
2	2 X	Divider Plate B
3	12 X	M5 x 10 Button Head Bolt
4	12 X	M5 x 10 x 1SS Flat Washer
5	12 X	M5 Nyloc Nut

TOOLS NEEDED

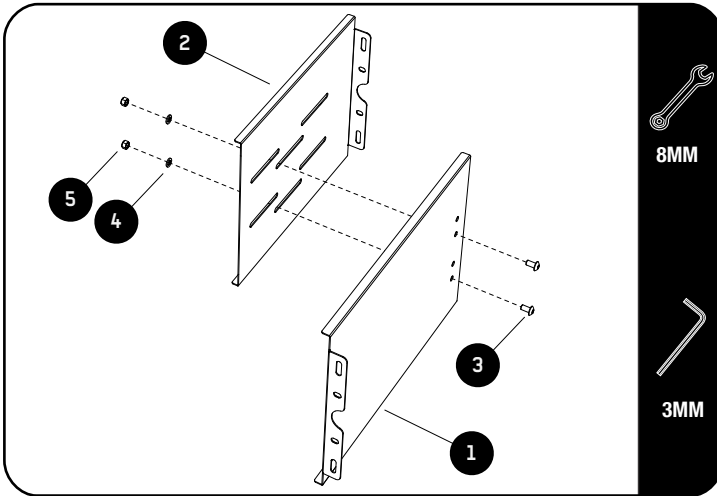


FIGURE 1.1



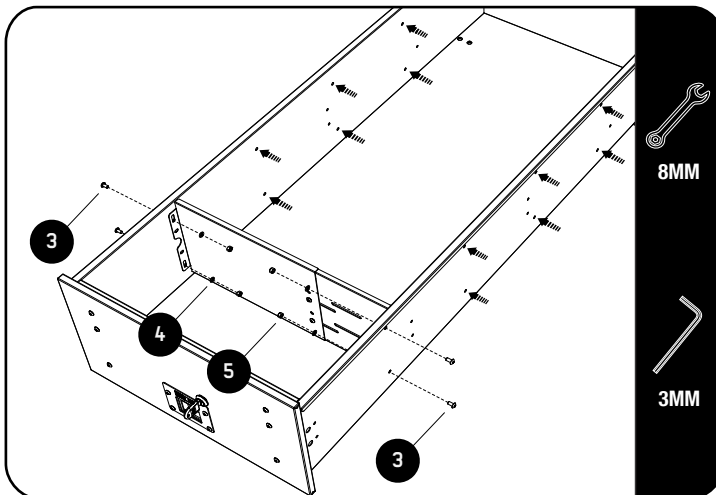
2**FIT AND SECURE**

2.1



Slide the Slotted Divider Plate B (Item 2) into the Solid Divider Plate A (Items 1). Adjust the two plates to the approximate width of the Drawer and loosely fasten the two plates together using two of the M5 x 10 Button Head Bolts, two M5 x 10 x 1SS Flat Washers and two M5 Nyloc Nuts (Items 3, 4 & 5). The Flat Washer and Nyloc Nut go on the side of the Slotted Plate.

2.2



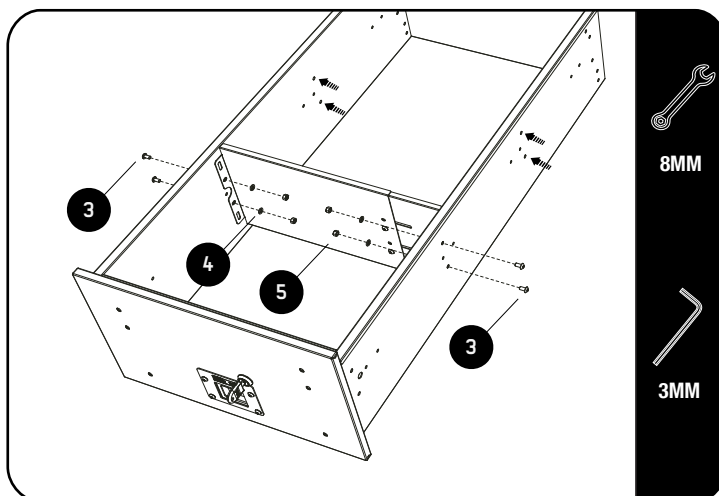
Depending on the drawer you have, you will be mounting to either the two outer holes or the inner holes on the side of the Drawer as shown in Step 2.2 and Step 2.3.

To fit the Divider Plates, open the Drawer and place the Divider Plates into the drawer with the Slotted Plate facing the rear of the drawer. Align the slots in the Divider Plates with the holes in the Drawer. Slide the Divider Plates apart, until flush against the sides of the Drawer.

Secure the Divider Plates to the Drawer using four M5 x 10 Button Head Bolts, four M5 x 10 x 1SS Flat Washers and four M5 Nyloc Nuts (Items 3, 4 & 5) as shown. The Nyloc Nuts and Flat Washers go on the inside of the Drawer.

Once the sides are secured, tighten the middle bolts from Step 2.1.

2.3



3

COMPLETION

3.1



Congratulations! You did it. Take a step back and admire your work!

4

Front Runner will not be responsible for any damage caused by the failure to install the product according to these instructions. Please call us if you have any questions about the installation of this product.

5

INSTALL OTHER VEHICLE AND RACK ACCESSORIES

Now's the time to visit your favorite Front Runner Dealer in person or Online.