



## Ford 351W Low Profile Hi-Ram Distributor 565-111

Holley EFI distributors are designed to plug and play with Holley EFI systems. This design includes dual Hall Effect sensors for crankshaft and camshaft signals provided to the ECU. It can be used as a crank speed input ONLY, as well as a cam sync signal, for sequential fueling operation. They can also be used for crank and cam signals for Coil-On-Plug applications with COP cap part number 566-103. The precision machined shutter wheel design ensures accurate timing, even at very high engine speeds. It can be used with other EFI systems that support Hall Effect crank and/or cam sensors inputs.

**NOTE:** The distributor comes with a hardened steel distributor gear that should be compatible with most hydraulic roller camshafts. It is recommended to consult your camshaft manufacturer prior to installation to confirm what distributor gear material they require.

1. The EFI software MUST be properly configured before installation. Failure to properly configure the ignition settings prior to distributor installation may cause erroneous LED readings during the alignment procedure.

Under System Parameters > Ignition Parameters



Enter an Ignition Type of “CUSTOM” from the drop-down menu, then Click the “Configure” button.  
The following are the proper settings for this Dual Sync distributor:

### **CRANK SENSOR**

**Type** – 1 pulse/fire

**Sensor Type** – DIGITAL FALLING

**Ignition Reference Angle** - 50.0 degrees

**Inductive Delay** – This parameter is used such that ignition timing does not under or over-advance as engine speed is increased. A starting value of 100 usec can be used. But once the engine is running, the engine should (safely) be run up to 3000-4000 RPM, and timing be checked such that it matches the commanded value. If it is lower than commanded, the Inductive Delay should be increased, if higher, the delay decreased.

### **CAM SENSOR**

**Type** – Single Pulse

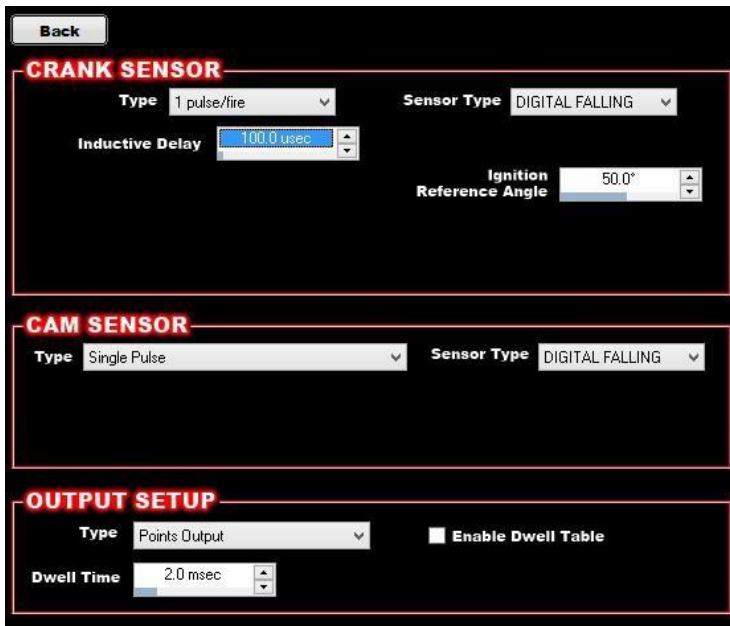
**Sensor Type** – Digital Falling

### **OUTPUT SETUP**

The following should be used if triggering a MSD Capacitive Discharge type ignition box.

**Type** – Points Output

**Dwell Time** – 2.0 msec



If using a Coil-On-Plug or other type of output, you will need to configure the output setup properly for your specific output type.

Once the software is properly configured, sync the new settings on your ECU and then proceed to distributor removal.

### DISTRIBUTOR REMOVAL:

1. Disconnect the battery NEGATIVE (-) cable and unplug the injector harness.
2. Disconnect the power and or ground connection at the coil/coils. Tape up any non-insulated power and ground terminals to eliminate any chance of a short circuit.
3. Rotate the crankshaft in the direction of engine rotation until it reads 50 degrees before top dead center (BTDC) on the compression stroke. Take the distributor cap off and make sure that the rotor is pointing to cylinder #1. If not, rotate the crankshaft one full revolution (as the engine is not on the compression stroke).

If your balancer is not marked at 50 degrees, take a tape measure and measure from the 0 degree mark to the following point (mark does NOT have to be exact):

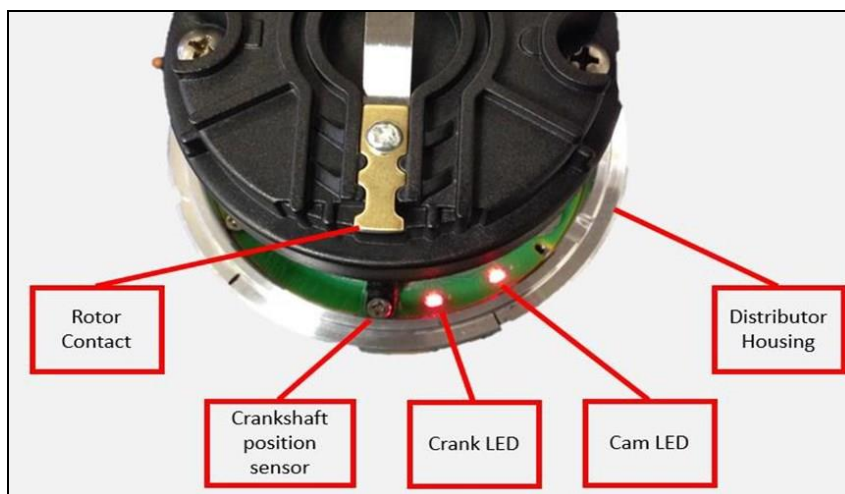
Balancer Diameter	Distance
6"	2-5/8"
7"	3-1/16"
8"	3-1/2"

4. Remove spark plug wires and all other wiring/vacuum hoses from distributor.
5. Remove distributor hold-down. Lift the distributor upwards and remove.

## DISTRIBUTOR INSTALL:

**NOTE:** If the engine block or heads have been milled, make sure that the distributor will fully seat and not bind or bottom out on the oil pump drive. A quick check is to remove the distributor gasket, and make sure that the distributor still fully seats on the mounting surface. If it does not, further investigation is needed.

1. Install the distributor gasket on the base of the distributor. If desired, apply adhesive between the gasket and distributor to hold it in place.
2. If the engine has already been broken in/run previously and is about to be fired immediately after the distributor install, coat the gear with motor oil. If the engine is new or will sit a while before it is fired, coat the distributor gear with a moly paste or camshaft break-in lube. Ensure no synthetic oils are used during the installation or break-in period. We recommend a standard 30 or 40 weight or Multi-Viscosity oil such as 10W-30 or 20W-50 to be used for the break-in period. Engines that produce oil pressure over 70psi when COLD should utilize a racing grade mineral oil for break-in. It is also recommended to monitor gear wear after the break-in period for several hours. Check the gear for proper mesh, tooth alignment, and for excessive tooth wear.
3. Position the rotor contact so it is pointing to the desired direction of the #1 spark plug wire. Insert the distributor and ensure that it is fully seated (**see NOTE above**). The rotor will rotate as you insert the distributor. If it does not land in the location you desire, remove the distributor and back it up a tooth or two at a time until you are satisfied with its location. You will need to make sure the oil pump drive shaft is turned in a direction that allows for the distributor shaft to mesh with it. **NOTE:** An engine oil priming tool is an ideal alternative to aid in aligning the oil pump drive shaft. Make sure that the drive shaft meshes and the distributor fully seats.
4. Next, connect the 10 pin distributor connector to the 10 pin Holley EFI main harness ignition adapter connector.
5. Reconnect the battery cable(s), **leaving the coil and injector connectors disconnected at this time.**
6. Turn the ignition key to the run position. (**DO NOT CRANK the engine.**) This will power the distributor.
7. **Distributor Alignment:** There are two LED's on the distributor circuit board. These will be used to align the distributor, by indicating when the crank and cam sensors are being triggered. The crank and cam LED's are noted in **Figure 1** below.



**Figure 1**

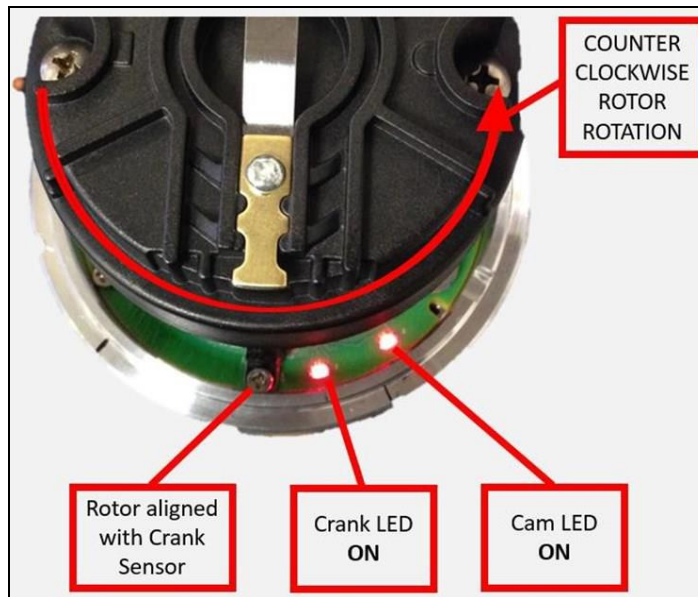
**NOTE:** All adjustments will be made by rotating the distributor housing only. **DO NOT ROTATE THE CRANKSHAFT** as it should remain at 50 degrees BTDC.

LED (**ON**) represents digital falling. LED (**OFF**) represents digital rising

**Your distributor will rotate counter-clockwise.**

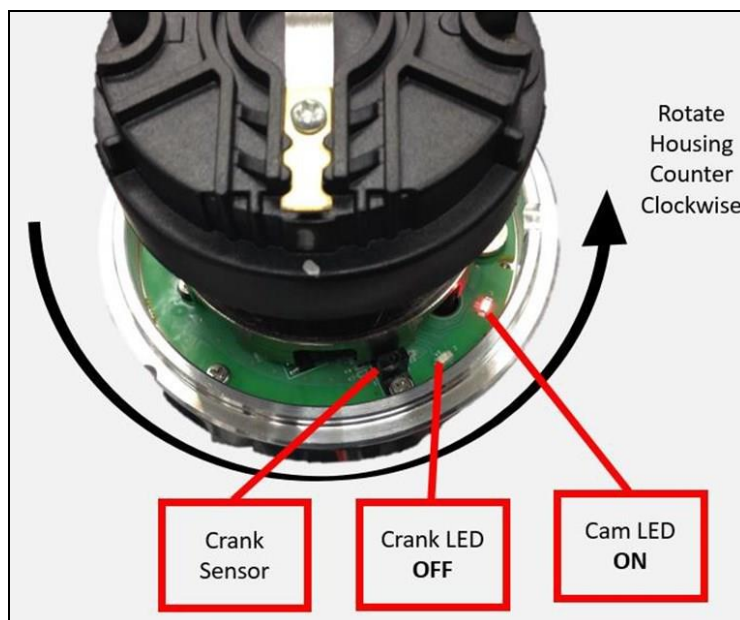
### **Counter-Clockwise Rotor Rotation:**

For engines that have the rotor rotating **counter-clockwise**, turn the housing until the rotor is pointed at the black crank position sensor (**Figure 2**). Both the cam and crank LED should be illuminated **ON**.



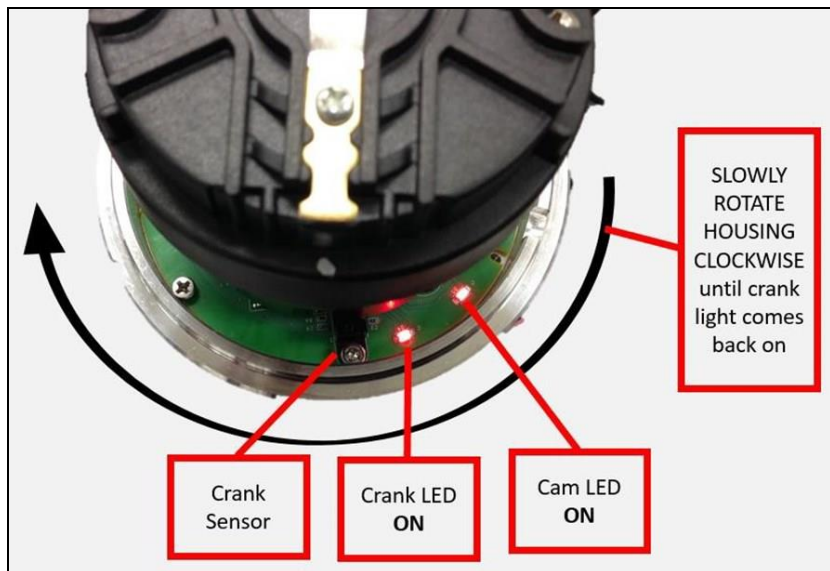
**Figure 2**

Slowly turn the housing **counter-clockwise** until the Crank LED goes **OFF** (**Figure 3**).

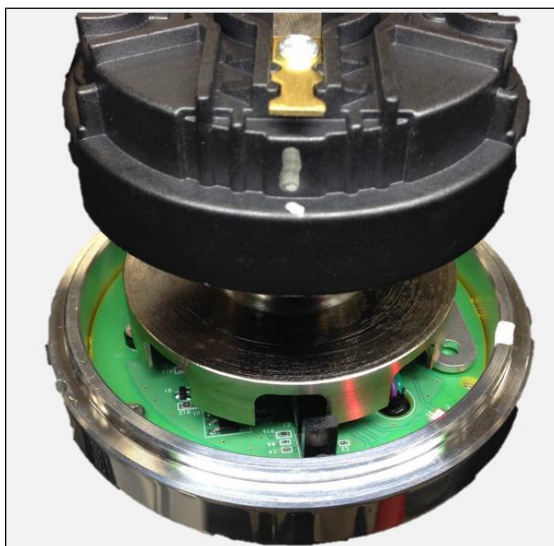


**Figure 3**

Turn the housing **clockwise** until the Crank LED comes back **ON** (**Figure 4**). Stop at this point. This will position the distributor close to where it needs to be. Install and snug the distributor clamp down at this point.



**Figure 4**



<b>Engine Family</b>	<b>Rotor Rotation</b>
Small/Big Block Chevy	Clockwise
Chrysler Small Block	Clockwise
Ford 351W	Counter-Clockwise
Ford 302	Counter-Clockwise
BB Chrysler Wedge	Counter-Clockwise
Ford FE	Counter-Clockwise
Oldsmobile	Counter-Clockwise
Pontiac	Counter-Clockwise

- Once step 7 is completed, the rotor will be pointing to the cylinder #1 terminal on the distributor cap (ensure the engine is still at 50 degrees BTDC on the compression stroke on cylinder #1). Note which position this is on the distributor cap. Install the cap and install the #1 plug wire. Install the rest of the plug wires based on the engine's firing order and rotor rotation. Reconnect the coil power and ground connection.

A wire retainer is supplied to secure the wires in place. Align the mounting bosses and use the supplied 1.5" self-tapping Phillips screws to hold the retainer in place.

9. It's time to check the timing. Confirm that the injector harness is still disconnected from step 1. This will ensure that no fuel will be sprayed from the injectors. Crank the engine over and check the timing with a timing light.
10. To make sure the ECU is getting an RPM signal, look at the "RPM" in the data monitor. Crank the engine over and make sure it shows RPM.
11. Next, check the timing with a timing light, it should be whatever the cranking timing is programmed to in the software (usually 15 degrees). If it's not close, turn the distributor until it is. Once it is, reconnect the fuel injectors and start the engine.
12. Once running, check the timing with a timing light and make sure it matches the commanded timing of the ECU. It is helpful to use the "Enable Static Timing Set" feature in the software that can lock the timing to a single value. It can be found in the same drop-down as the TPS Auto-set feature. If it does not, rotate the distributor until it does.

Once synced, CAREFULLY rev the engine up to 3000-4000 RPM and make sure the timing still matches. If it is advanced, lower the Inductive Delay value by about 20. If it is retarded, raise the Inductive Delay value about 20. Cycle the ignition power after making this change. Once the timing matches at idle and higher RPM, lock the distributor down and you are done.

## DISTRIBUTOR PINOUT:

If custom wiring the distributor, use the following pinout:

Connector Location	Channel	Wire Color
A	Crank Signal	Purple/White
B	Cam Signal	Purple
C	Signal Ground	Green
E	Switched +12V	Red

## MISCELLANEOUS COMPONENTS:

Bronze Gear for 351W – MSD PN 8585

Replacement Cap MSD 84313 – Rotor MSD 8467

Coil On/Near Plug Cap – Holley PN 566-103 – This low profile cover eliminates the rotor and distributor cap when using Coil-On/Near Plug ignition systems.

## GEAR INSTALLATION ON FORD DISTRIBUTORS:

It is recommended to send your Ford Distributor to MSD to have a new gear installed. The MSD Tech Department can be reached at 888-258-3835. The installation process requires a press fit and the need for special tools to achieve proper installation without damaging the shaft, gear or housing. If returning the distributor to MSD is not an option, a quality machine shop may also be able to install your new gear.

**CAUTION: If the gear is installed improperly, severe damage to the distributor and/or engine block will occur!**

1. With the endplay of the distributor shaft removed, measure the distance from the bottom of the gear to the bottom of the mounting flange (**Figure 5**). It should be within the specifications shown.

2. Scribe a mark on the shaft at the bottom of the gear. This will aid in the installation position of the new gear.
3. Remove the original roll pin and remove the press fit gear. Use extreme care not to damage the end of the shaft where it meshes with the oil pump.
4. Position the gear so the new roll pin will enter the shaft 90° from the original hole. (Lining up the original hole is possible, but a new hole will likely be machined.)
5. Press the new gear into position on the shaft. Measure the distance as shown in **Figure 5** before drilling the new roll pin hole.
6. Carefully drill a 0.125" hole through the shaft using the gear as a guide.
7. Install the new 1/8" spiral roll pin.

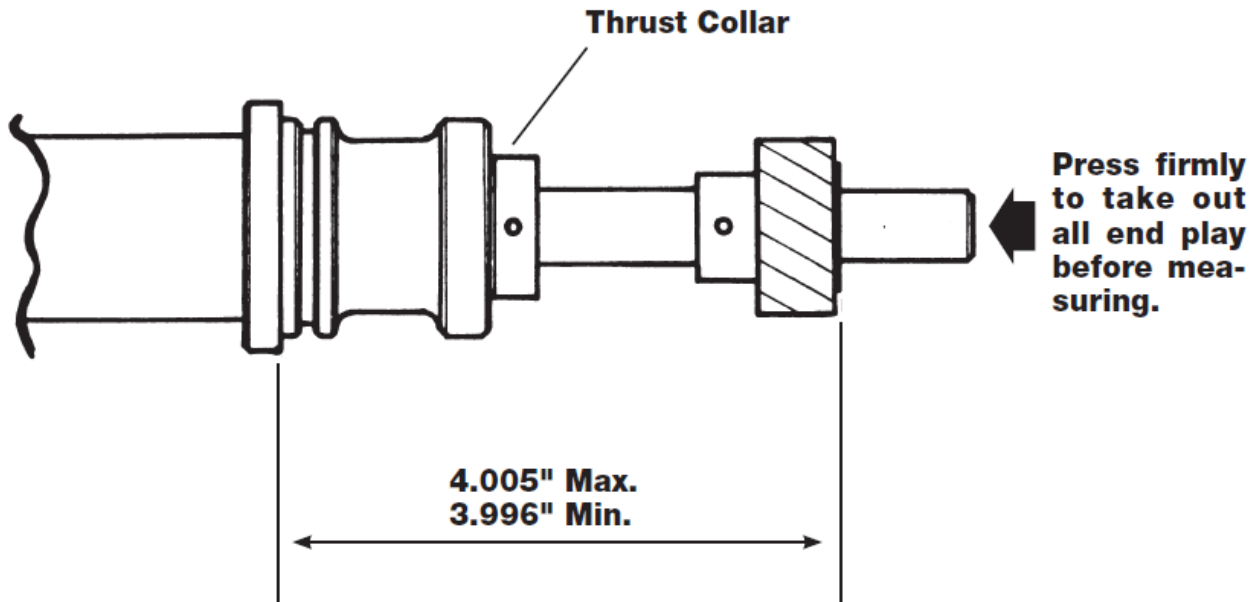


Figure 5 Gear Installation Specifications

199R11320  
Date: 4-28-17

FRM34554