



INTAKE SYSTEMS FOR VEHICLES LISTED ARE 50 STATE LEGAL. SEE KNFILTERS.COM FOR CARB STATUS ON EACH PART FOR A SPECIFIC VEHICLE.

INSTALLATION INSTRUCTIONS

57-2551 LINCOLN 2003-04 Navigator V8-5.4L DOHC

NOTE: This kit was not designed to fit vehicles with a body lift.

TOOLS NEEDED:

- Small Flat Blade Screwdriver
- Flat Blade Screwdriver
- 4mm Allen
- 10mm Wrench
- Ratchet Extension
- 8mm Socket
- 10mm Socket
- 11mm Socket
- Pliers

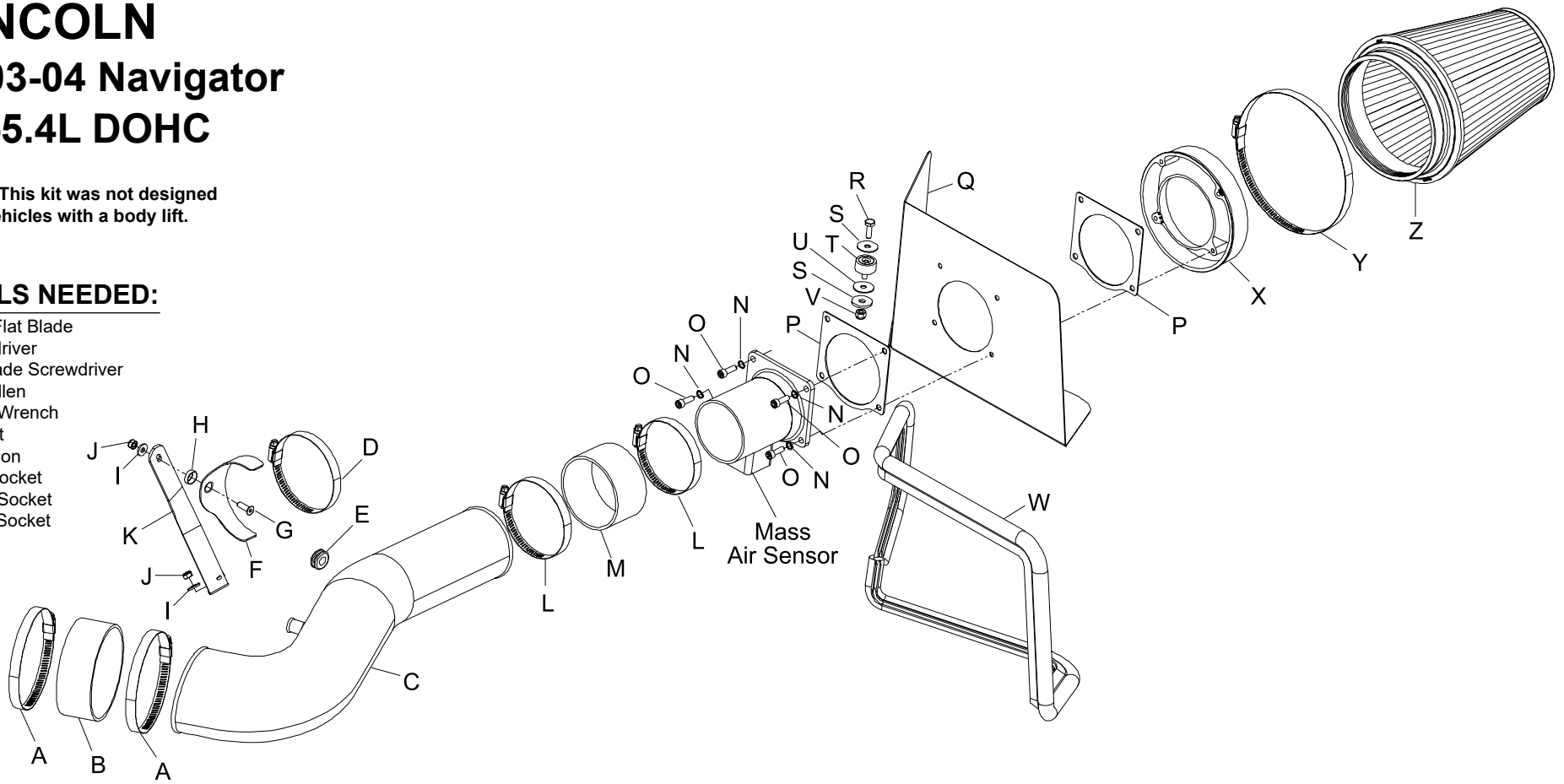

PARTS LIST:

Description	Qty.	Part #	Description	Qty.	Part #	Description	Qty.	Part #
A hose clamp #72	2	08671	J nut, 6mm nylock	2	07553	S washer, 1" X 1/4" hole	2	08160
B hose; 4.5" id x 1.75" l	1	08623	K bracket: long, twisted (L)	1	010094	T stud; 1/4-20 m/f rubber	1	08011
C intake tube (EQ)	1	087158A	L hose clamp #56	2	08620	U washer; 1" x .300 x .063 rubber	1	21685
D hose clamp #52	1	08610	M hose, 3.5" id x 2" L	1	08630	V nut, 1/4"-20	1	07517
E grommet, 7/16" id	1	08092	N washer, 1/4" split lock	4	08198	W edge trim 48"L	1	102485A
F bracket; saddle	1	078855	O bolt, m6-1.00 x 20mm	4	07852	X adapter #250	1	08785A
G bolt, m6-1.00 x 20mm	1	08376	P gasket; 1/16" neoprene	2	09984	Y hose clamp # 104	1	08697
H washer, black, nylon	1	08180	Q heat shield	1	074033	Z air filter	1	RU-1020
I washer; 1/4" id X 5/8" od, flat	2	08275	R bolt, 1/4"-20 X 3/4"	1	08386			

NOTE: FAILURE TO FOLLOW INSTALLATION INSTRUCTIONS AND NOT USING THE PROVIDED HARDWARE MAY DAMAGE THE INTAKE TUBE, THROTTLE BODY AND ENGINE.

TO START:

1. Turn off the ignition and disconnect the negative battery cable.
NOTE: Disconnecting the negative battery cable erases pre-programmed electronic memories. Write down all memory settings before disconnecting the negative battery cable. Some radios will require an anti-theft code to be entered after the battery is reconnected. The anti-theft code is typically supplied with your owner's manual. In the event your vehicles' anti-theft code cannot be recovered, contact an authorized dealership to obtain your vehicles anti-theft code.



2. Loosen and remove two bolts that retain the engine cover, then remove cover.



3. Disconnect the air temp sensor electrical connection.



4. Remove the crank case valve hose from the stock intake tube.



5. Loosen the hose clamp on the stock intake tube at the throttle body.



6. Detach the stock intake tube from the throttle body and lift up on the air cleaner assembly to release it from its retaining grommets.

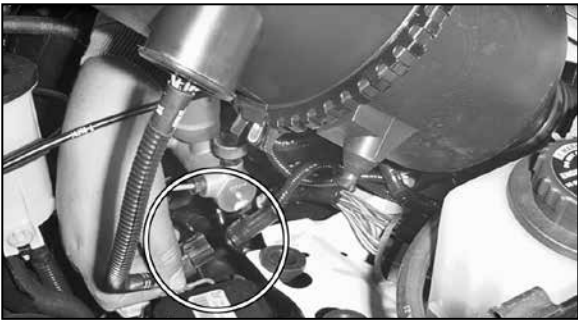

7. Disconnect the secondary mass air sensor electrical connection.



8. Remove the entire stock air intake assembly from the vehicle.

NOTE: K&N Engineering, Inc., recommends that customers do not discard factory air intake.

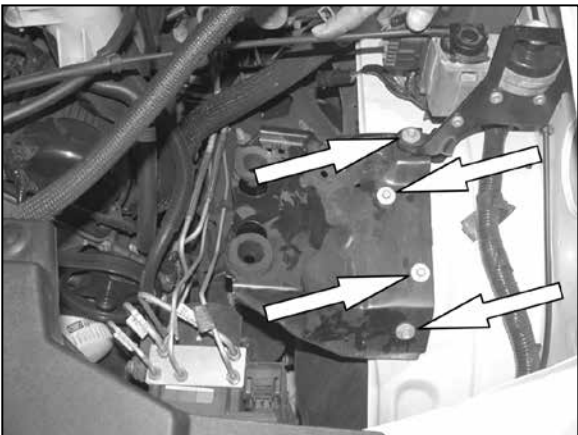

9. Using an 8mm socket, remove the 4 bolts that retain the airbox mounting bracket.



10. Remove the airbox mounting bracket from vehicle.



11. Slide the rubber grommet back and disconnect the primary mass air sensor electrical connection, using a flat blade screwdriver.



12. Open the air cleaner assembly and isolate the mass air sensor assembly.



13. Using a flat blade screwdriver, push in and release the four clips that retain the mass air sensor retaining plate.

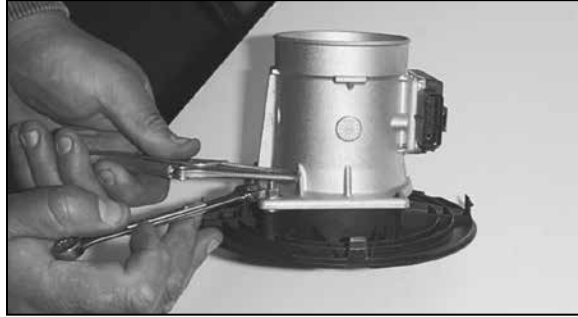

14. Using a pair of small vise grips or pliers, hold the stud while using a 10mm wrench to loosen the nuts, then remove the mass air sensor from the retaining plate.

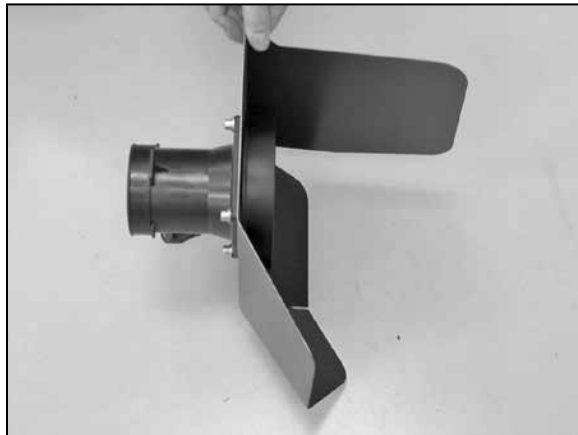

15. Assemble the heat shield and filter adapter onto the mass air sensor with the provided gaskets and hardware.



16. Install the edge trim onto the heat shield as shown. Trim if necessary.



17. Remove the air temp. sensor from the stock air intake tube.



18. On vehicle's equipped with an external air temperature, drill a 5/8" hole in the K&N® intake tube at the drill point as shown.

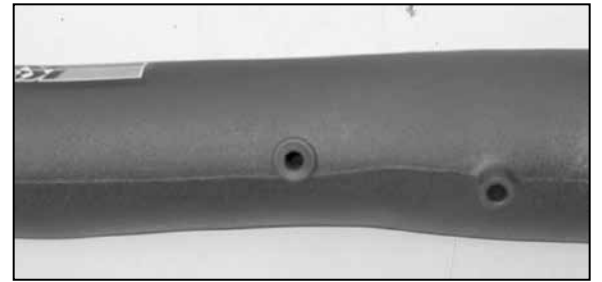

19. Install the provided grommet into the new intake tube as shown.



20. Install the air temp sensor into the grommet as shown.

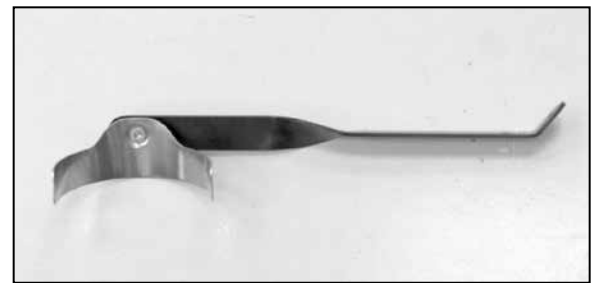

21. Assemble the saddle bracket assembly as shown.



22. Release the wire harness from valve cover stud as shown.



23. Install the saddle bracket assembly onto the valve cover stud with the provided hardware, then wire tie the wiring harness to bracket as shown.

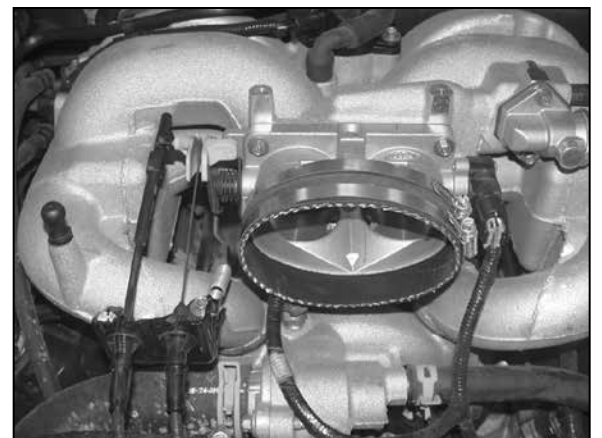

24. Install the silicone hose (08623) onto the throttle body with the provided hose clamps. **NOTE: Be sure to position the worm gears toward the driver side, away from all moving throttle components.**



25. Install the new K&N® intake tube onto the throttle body and saddle bracket with the provided hose clamps.

NOTE: Do not tighten the hose clamps completely.



26. Install the provided rubber mounted stud under the cruise control bracket as shown.

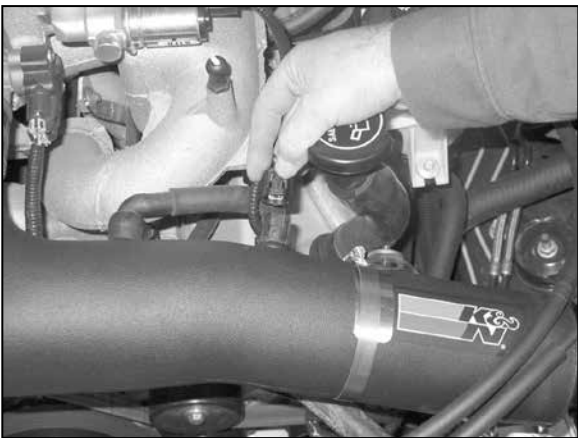

27. Reconnect the crank case valve vent, then reconnect the air temp sensor electrical connection as shown.



28. Install the silicone hose (08630) onto the mass air sensor.



29. Install the mass air assembly onto the K&N® intake tube as shown.

NOTE: Adjust the saddle bracket assembly so the heat shield sits below the inner fender lip as shown.

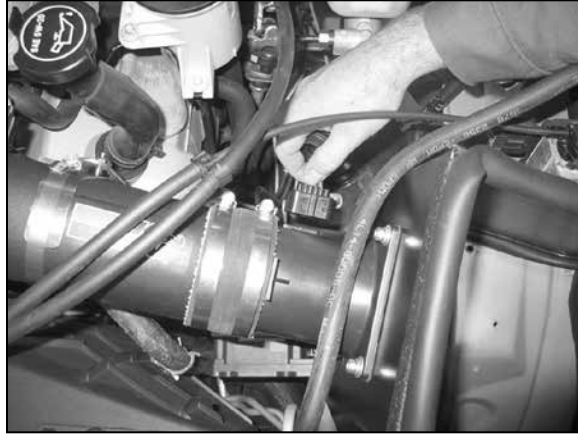

30. Reconnect the mass air sensor electrical connection as shown. Also reconnect the secondary electrical connection



31. Install the K&N® air filter onto the mass air sensor assembly as shown.

NOTE: Drycharger® air filter wrap; part # RF-1020DK is available to purchase separately. To learn more about Drycharger® filter wraps or look up color availability please visit <http://www.knfilters.com>®.



32. Reconnect the vehicle's negative battery cable. Double check to make sure everything is tight and properly positioned before starting the vehicle.

33. The C.A.R.B. exemption sticker, (attached), must be visible under the hood so that an emissions inspector can see it when the vehicle is required to be tested for emissions. California requires testing every two years, other states may vary.

34. It will be necessary for all K&N® high flow intake systems to be checked periodically for realignment, clearance and tightening of all connections. Failure to follow the above instructions or proper maintenance may void warranty.

ROAD TESTING:

1. Start the engine with the transmission in neutral or park, and the parking brake engaged. Listen for air leaks or odd noises. For air leaks secure hoses and connections. For odd noises, find cause and repair before proceeding. This kit will function identically to the factory system except for being louder and much more responsive.

2. Test drive the vehicle. Listen for odd noises or rattles and fix as necessary.

3. If road test is fine, you can now enjoy the added power and performance from your kit.

4. K&N Engineering, Inc., requires cleaning the intake system's air filter element every 100,000 miles. When used in dusty or off-road environments, our filters will require cleaning more often. We recommend that you visually inspect your filter once every 25,000 miles to determine if the screen is still visible. When the screen is no longer visible some place on the filter element, it is time to clean it. To clean and re-oil, purchase our filter Recharger® service kit, part number 99-5050 or 99-5000 and follow the easy instructions.

INTAKE SYSTEMS FOR VEHICLES LISTED ARE 50 STATE LEGAL. SEE KNFILTERS.COM FOR CARB STATUS ON EACH PART FOR A SPECIFIC VEHICLE.