



AIRCHARGER®

HIGH-FLOW INTAKE KITS

LEGAL IN CALIFORNIA ONLY FOR RACING VEHICLES WHICH MAY NEVER BE USED, REGISTERED OR LICENSED FOR USE UPON A HIGHWAY. See knfilters.com for CARB status on each part for a specific vehicle

INSTALLATION INSTRUCTIONS

63-9034
TOYOTA
2010-14 FJ Cruiser
2010-24 4Runner
V6-4.0L

TOOLS NEEDED:

- Ratchet
- Extension
- 13mm Socket
- 12mm Socket
- 10mm Socket
- 10mm Wrench
- 4mm Allen Wrench
- 3mm Allen Wrench
- Pliers
- Flat Blade Screw Driver

NOTE: This kit was not designed to fit vehicles with a body lift.

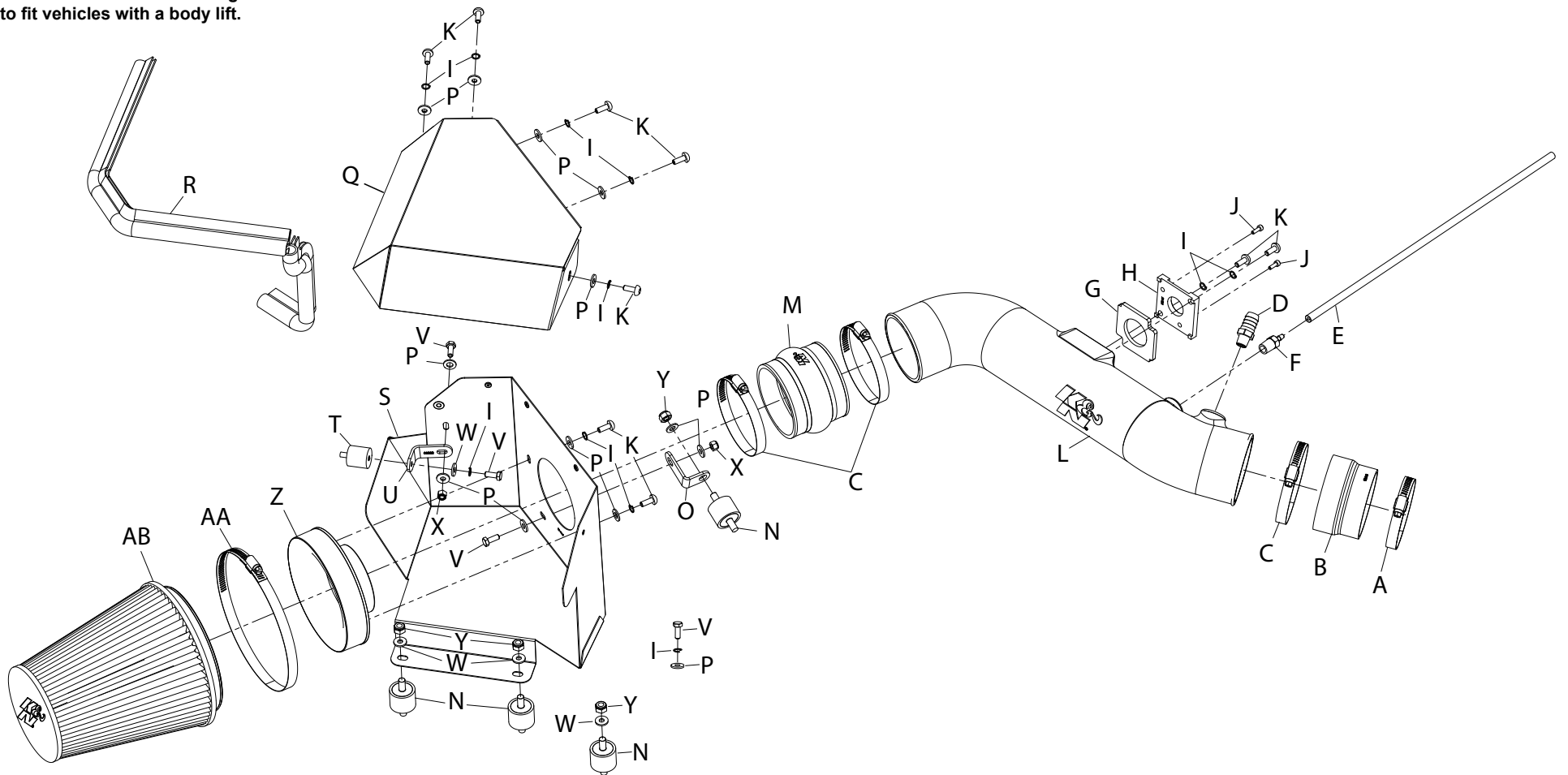

PARTS LIST:

Description	Qty.	Part #	Description	Qty.	Part #	Description	Qty.	Part #
A HOSE CLAMP #48	1	08601	K BOLT; M6 X 1 X 16MM, BTNHD	9	07730	U BRACKET; "L"	1	070712A
B HOSE; 3.25" ID TO 3.5" ID X 2.25"	1	084091	L INTAKE TUBE; (HX)	1	087238A	V BOLT; M6-1 X 16MM, HEX	4	07812
C HOSE CLAMP #56	3	08620	M HOSE; HUMP 3.5" ID X 3" L	1	084057	W WASHER; 8MM, FLAT	4	08272
D FITTING; VENT, 1/4" NPT	1	82638	N MOUNT; RUBBER 1" X 8MM	4	1228560	X NUT; 6MM NYLOCK, HEXHD	2	07512
E HOSE; 4MM ID X 18" L	1	08153	O BRACKET; "L"	1	08022	Y NUT; 8MM NYLOCK	4	07502
F FITTING; 1/4" NPT, 3/16 BARB	1	080021	P WASHER; 1/4" ID X 5/8" OD	13	08275	Z ADAPTER; UNIV. 6"	1	21512-1
G GASKET; 3/16" PORON	1	09074	Q HEAT SHIELD; LID	1	074068	AA HOSE CLAMP #104	1	08697
H ADAPTER; MASS AIR; (GF)	1	21521	R EDGE TRIM; (30"L)	1	102489	AB AIR FILTER	1	RU-1048
I WASHER; 1/4" LOCK	11	08198	S HEAT SHIELD	1	074067-1			
J BOLT; M4-.7 X 8MM, ALNHD	2	07733	T STUD; M6 X 1, 1"T	1	02033			

If you need any assistance please call 1-800-858-3333 to speak with a representative in our Customer Service Center before returning the product.

NOTE: FAILURE TO FOLLOW INSTALLATION INSTRUCTIONS AND NOT USING THE PROVIDED HARDWARE MAY DAMAGE THE INTAKE TUBE, THROTTLE BODY AND ENGINE.

TO START:

1. Turn off the ignition and disconnect the negative battery cable.
NOTE: Disconnecting the negative battery cable erases pre-programmed electronic memories. Write down all memory settings before disconnecting the negative battery cable. Some radios will require an anti-theft code to be entered after the battery is reconnected. The anti-theft code is typically supplied with your owner's manual. In the event your vehicles anti-theft code cannot be recovered, contact an authorized dealership to obtain your vehicles anti-theft code.



2. Lift up the engine cover to dislodge it from the mounting grommets and then remove the cover from the vehicle.



3. Disconnect the mass air sensor electrical connection and then unhook the wiring harness from the air box.
NOTE: The wiring harness attaches in three locations.



4. Unhook the fuel pressure vent line from the fuel pressure regulator.



5. Disconnect the crank case vent hose from the stock intake tube.



6. Remove the bolt which secures the tube mounting bracket to the engine valve cover.



7. Loosen the hose clamp which secures the intake tube to the throttle body.



8. Release the four clips which secure the upper air box to the lower air box and then remove the intake tube and upper air box from the vehicle.

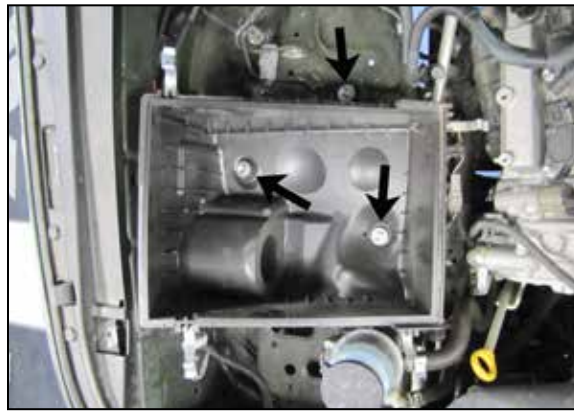

9. Loosen and remove the three bolts securing the lower air box and then remove the lower air box from the vehicle.

NOTE: K&N Engineering, Inc., recommends that customers do not discard factory air intake.

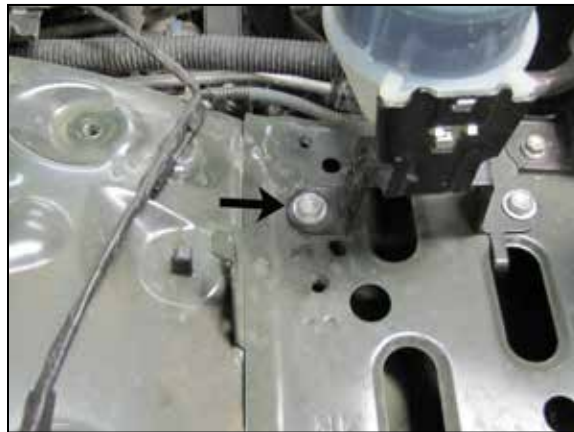

10. Remove the rear P/S reservoir mounting bolt shown.



11. On models with the Air injection pump located in front of the air box next to the Power steering reservoir, remove the three bolts securing the pump to the inner fender.

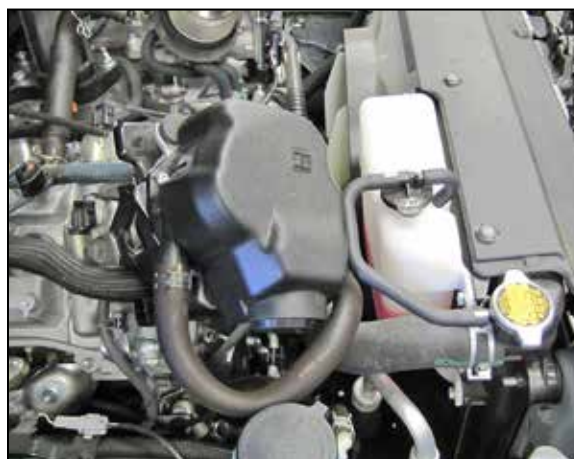

11a. Lift up the air injection pump, disconnect the electrical connection and then set the air injection pump over to side.



12. Install the four rubber mounted studs into the factory air box and P/S reservoir as shown. **NOTE: The forward most rubber mounted stud is only used if the vehicle is equipped with the air injection pump located in front of the factory air box.**



13. Install the 6mm rubber mounted stud into the inner fender location shown.

NOTE: On some models, a horn may be attached in this location.

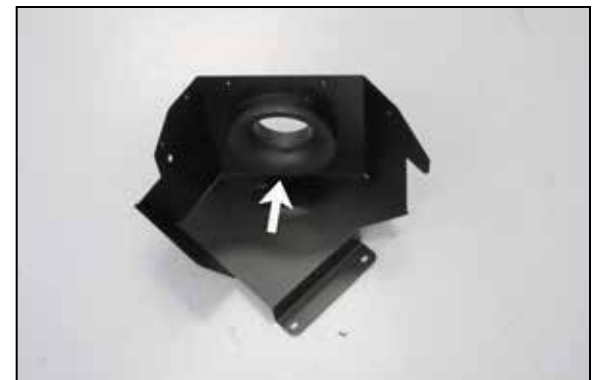

14. Install the filter adapter into the heat shield and secure with the provided hardware.



15. Install the provided mounting bracket (070712A) onto the heat shield and secure with the provided hardware.



16. Install the provided mounting bracket (08022) onto the heat shield and secure with the provided hardware.

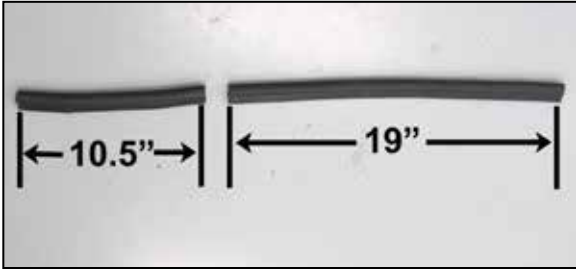

17. Cut the provided edge trim into two lengths as shown. One section is to be 10.5" long and one section is to be 19" long.

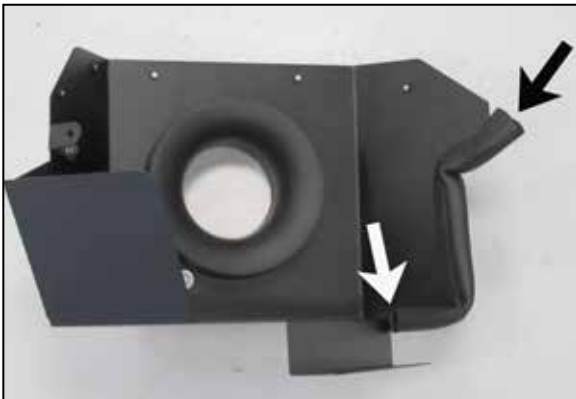

18. Install the 10.5" long piece onto the heat shield as shown.



19. Set the heat shield onto the rubber mounted studs and then secure with the provided hardware. **NOTE: On models that had a horn attached in this location, be sure to reattach the horn between the heat shield bracket and rubber mounted stud.**



19a. Install the air injection pump onto the heat shield and forward rubber mounted stud and then secure with the provided hardware. Reconnect the air injection pump electrical connection.



20. Install the provided silicone hump hose (084057) onto the filter adapter and secure with the provided hose clamp.



21. Install the provided silicone step hose (084091) onto the throttle body and secure with the provided hose clamp.



22. Install the provided gasket onto the K&N® mass air sensor adapter as shown.



23. Remove the screws which secure the mass air sensor to the factory air box and then remove the mass air sensor from the air box.



24. Install the mass air sensor into the K&N® mass air sensor adapter and secure with the provided hardware.



25. Install the mass air sensor assembly into the K&N® intake tube and secure with the provided hardware.

NOTE: Be sure to place the mass air sensor with the opening towards the filter end of the tube as in photo.



26. Install the 5/8 vent fitting into the K&N® intake tube as shown.

NOTE: NPT fitting has tapered threads and only designed to be installed until hand tight, then tighten one rotation or when the fitting becomes difficult to return.



27. Install the 3/16 vent fitting into the K&N® intake tube as shown.



28. Install the K&N® intake tube into hump hose at the filter adapter and then into the silicone hose at the throttle body, align the tube for proper fit and then tighten the hose clamps.



29. Connect the crank case vent line to the 5/8 vent fitting and secure with the factory spring clamp.



30. Connect the provided fuel pressure vent line to the fuel pressure regulator and then connect the open end to the 3/16 vent fitting in the K&N® intake tube.



31. Install the K&N® air filter onto the filter adapter and secure with the provided hose clamp.

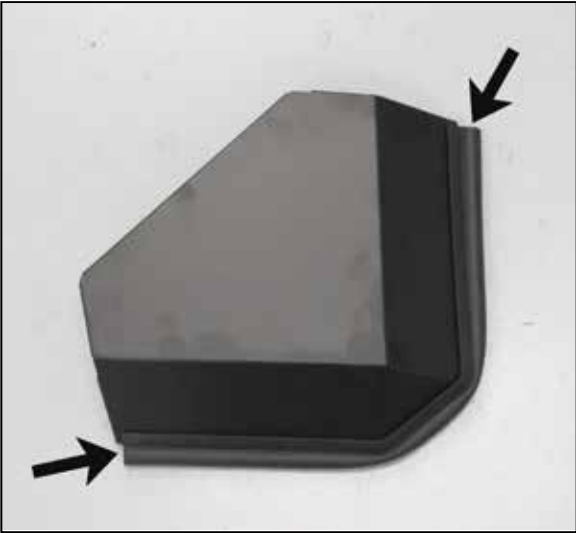

32. Install the remaining 19" piece of edge trim onto the heat shield cover as shown.



33. Install the heat shield cover onto the heat shield and secure with the provided hardware.

NOTE: Use of the heat shield cover is not mandatory; it is recommended that the cover is used during conditions of heavy moisture such as water crossings where water can be thrown from the engine fan.



34. Reinstall the engine cover onto the engine.



35. Reconnect the mass air sensor electrical connection.

36. Reconnect the vehicle's negative battery cable. Double check to make sure everything is tight and properly positioned before starting the vehicle.

37. It will be necessary for all K&N® high flow intake systems to be checked periodically for realignment, clearance and tightening of all connections. Failure to follow the above instructions or proper maintenance may void warranty.

ROAD TESTING:

1. Start the engine with the transmission in neutral or park. Listen for air leaks or odd noises. For air leaks secure hoses and connections. For odd noises, find cause and repair before proceeding. This kit will function identically to the factory system except for being louder and much more responsive.

2. Test drive the vehicle. Listen for odd noises or rattles and fix as necessary.

3. If road test is fine, you can now enjoy the added power and performance from your kit.

4. K&N Engineering, Inc., requires cleaning the intake system's air filter element periodically for excessive dirt build-up. When used in harsh terrain conditions or off-road environments, our filters will require cleaning more often. We recommend that you visually inspect your filter more frequently when used in harsh terrain conditions to determine if the screen is still visible. When the screen is no longer visible some place on the filter element, it is time to clean it. To clean and re-oil, purchase our filter Recharger® service kit, part number 99-5050 or 99-5000 and follow the easy instructions.

LEGAL IN CALIFORNIA ONLY FOR RACING VEHICLES WHICH MAY NEVER BE USED, REGISTERED OR LICENSED FOR USE UPON A HIGHWAY.

See knfilters.com for CARB status on each part for a specific vehicle