



TYPHOON INTAKE SYSTEMS™

SOME INTAKE SYSTEMS ARE NOT LEGAL FOR SALE OR USE ON ANY POLLUTION CONTROLLED MOTOR VEHICLE IN CALIFORNIA OR STATES ADOPTING CALIFORNIA EMISSION PROCEDURES. See knfilters.com for CARB status on each part for a specific vehicle

INSTALLATION INSTRUCTIONS

**69-1008TS
69-1008TB
HONDA
2001-05 Civic
L4-1.7L / 1.6L**

NOTE: C.A.R.B. E.O.# D-269-32
APPLIES ONLY TO L4-1.7L MODELS

TOOLS NEEDED:

- Flat Blade Screwdriver
- Ratchet
- 3" Extension
- 6" Extension
- 14" Extension
- 8mm Socket
- 10mm Socket
- Pliers
- 4mm Allen Wrench

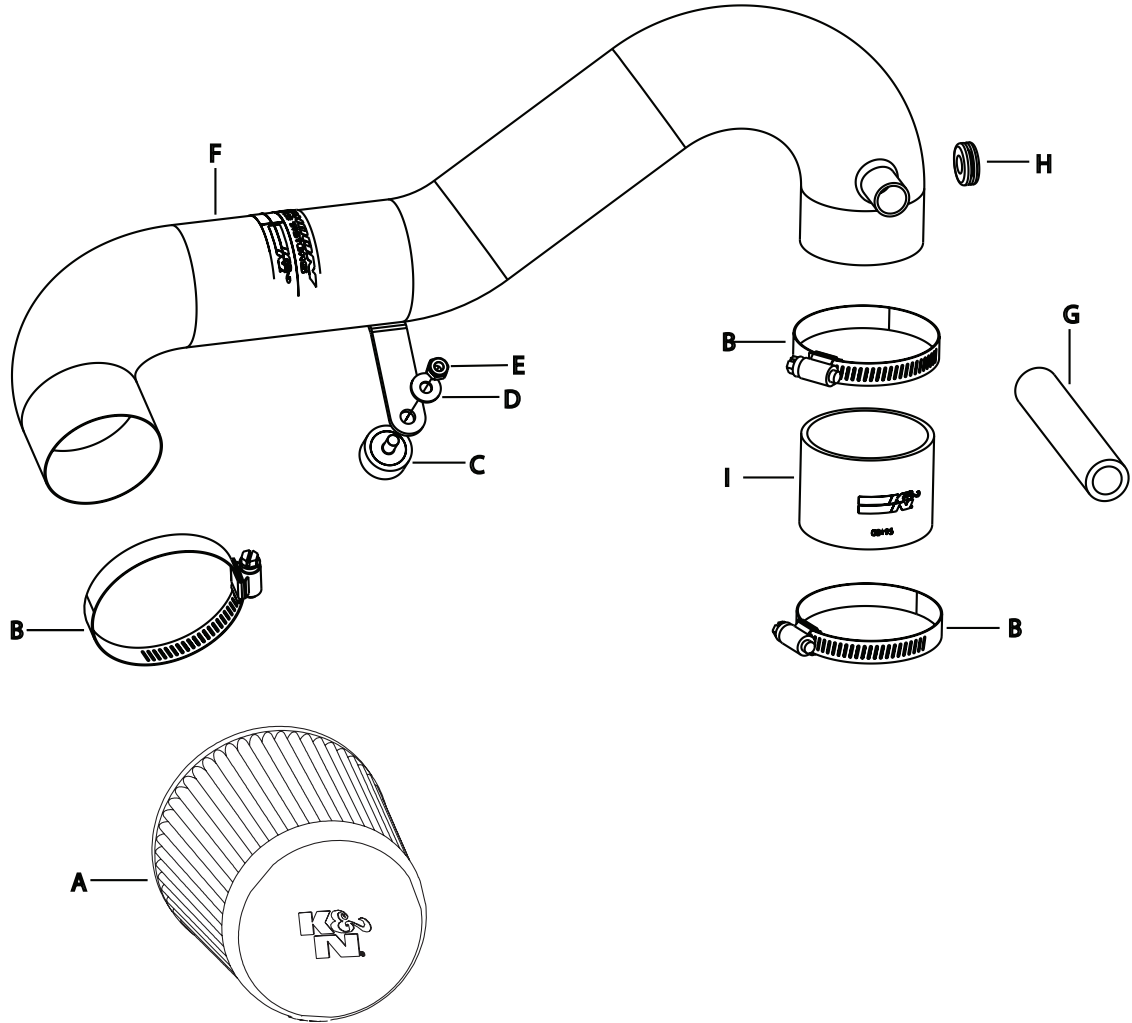

PARTS LIST:

Description	Qty.	Part #
A Filter	1	RU-4950
B Hose clamp, #40	3	08554
C Rubber mounted stud	1	07027
D Flat washer	1	08269
E 6mm Nylock Nut	1	07512
F Intake Tube	1	087036-1
G Silicone Hose, 5/8" x 5"L	1	08538
H Grommet, 5/8" ID	1	08283
I Silicone Hose, Black	1	08284

NOTE: FAILURE TO FOLLOW INSTALLATION INSTRUCTIONS AND NOT USING THE PROVIDED HARDWARE MAY DAMAGE THE INTAKE TUBE, THROTTLE BODY AND ENGINE.

TO START:

1. Turn off the ignition and disconnect the negative battery cable.

NOTE: Disconnecting the negative battery cable erases pre-programmed electronic memories. Write down all memory settings before disconnecting the negative battery cable. Some radios will require an anti-theft code to be entered after the battery is reconnected. The anti-theft code is typically supplied with your owner's manual. In the event your vehicles' anti-theft code cannot be recovered, contact an authorized dealership to obtain your vehicles anti-theft code.



2. Disconnect the air temperature sensor electrical connection as shown.



3. Unclip the battery cable from the air inlet duct as shown.



4. Loosen and remove the two bolts that secure the air inlet duct as shown.



5. Remove the air inlet duct.

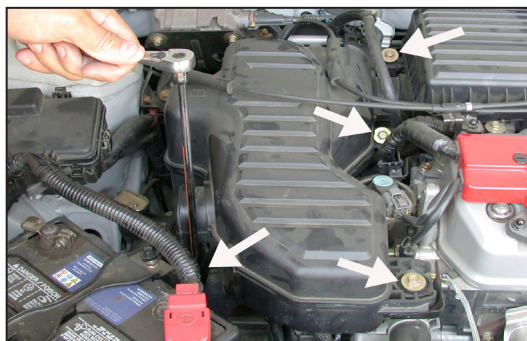

6. Loosen and remove the four bolts that secure the air intake resonator.

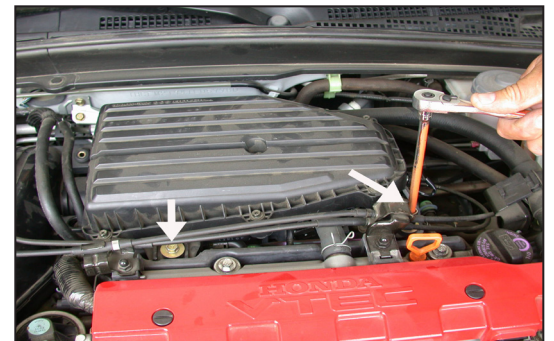

7. Loosen and remove the two bolts that secure the throttle body plenum.



8. Loosen the hose clamp that secures the plenum to the throttle body as shown.



9. Using a pair of pliers, depress and pull back the hose clamp on the crankcase vent at the cam cover.



10. Pull firmly upwards to remove the throttle body plenum as shown.



11. Using a flat blade screwdriver, unclip the wire harness from the resonator as shown.



12. Unclip the throttle cable and cruise control cable (if equipped), then, remove the resonator by pulling upwards as shown.
NOTE: K&N Engineering, Inc., recommends that customers do not discard factory air intake.

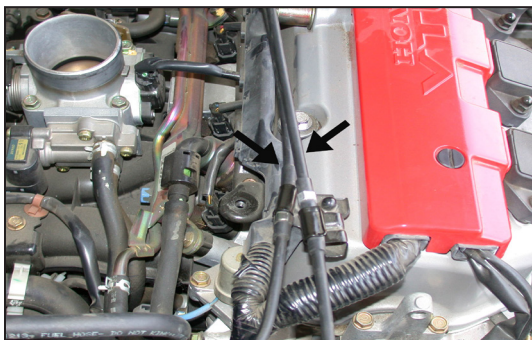

13. Secure the throttle cable and cruise control cable (if equipped) to the stock clips as shown.

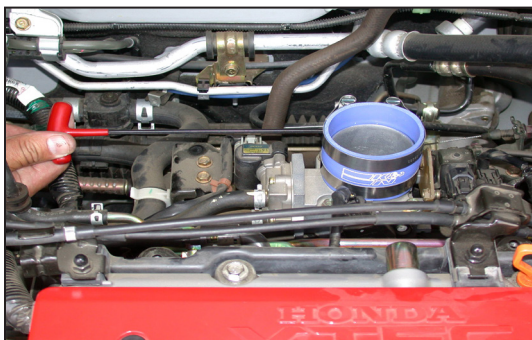

14. Install the silicone hose and hose clamps onto the throttle body. Do not tighten at this time.

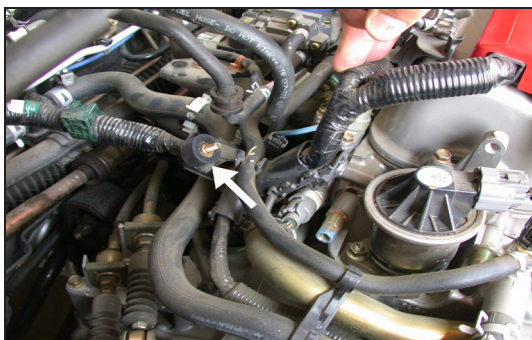

15. Install the rubber mounted stud onto the stock resonator mounting location as shown.

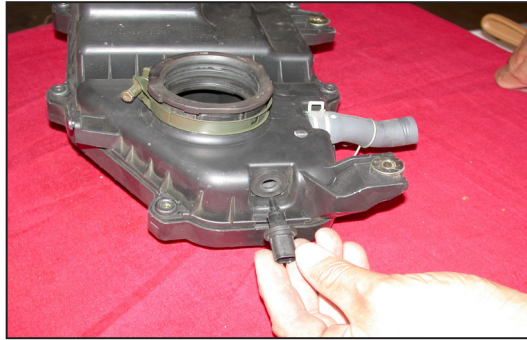

16. Remove the air temperature sensor from the throttle body plenum as shown.



17. Install the provided rubber grommet into the hole on the K&N® intake tube, then install the air temperature sensor into the grommet as shown.
NOTE: Before installing the grommet and air temperature sensor, inspect the inside of the tube for any debris, then clean the inside out with water and a towel. Inspect the tube one more time before proceeding to the next step.

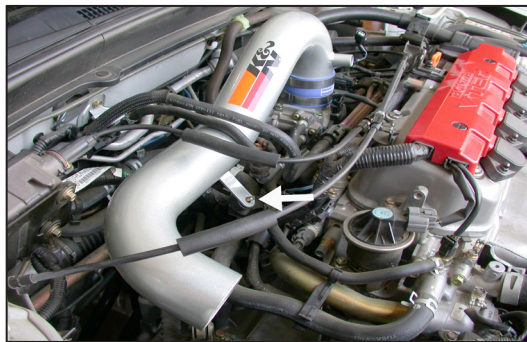

18. Install the K&N® intake tube onto the throttle body, then, line up the bracket with the rubber mounted stud as shown. Tighten hose clamps at this time.

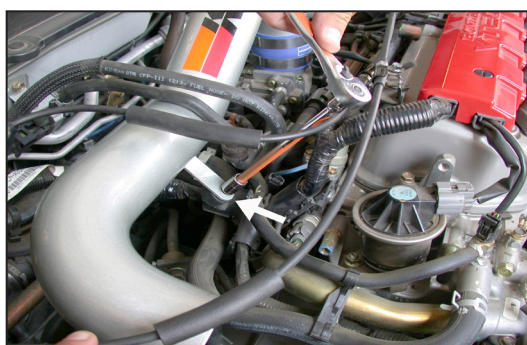

19. Secure the bracket to the rubber mounted stud using the provided hardware, but do not tighten completely at this time.

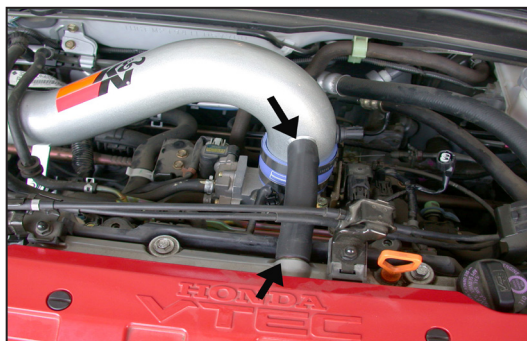

20. Install the provided silicone hose onto the crankcase vent on the cam cover, then connect the other end to the vent on the K&N® intake tube as shown.

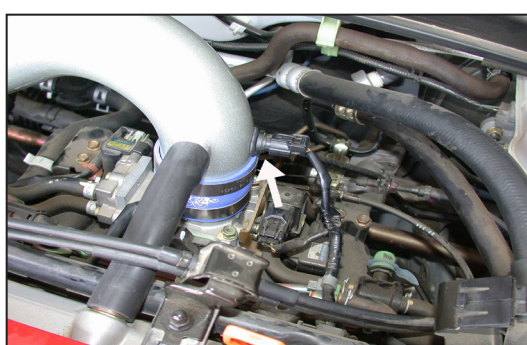

21. Reconnect the air temperature sensor electrical connection as shown.

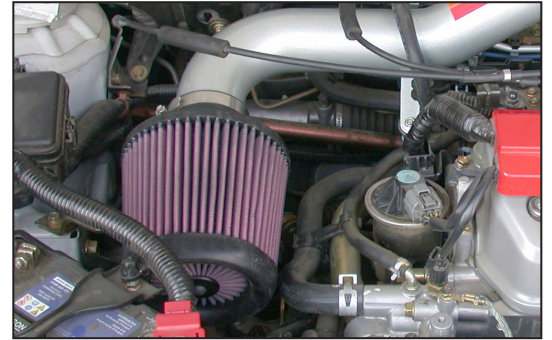

22. Install the K&N® air filter onto the K&N® intake tube and secure with the provided hose clamp. Adjust for best fit and clearance then tighten all hardware.
NOTE: Drycharger® air filter wrap; part # RX-4990DK is available to purchase separately. To learn more about Drycharger® filter wraps or look up color availability please visit <http://www.knfilters.com>.



23. Reconnect the vehicle's negative battery cable. Double check to make sure everything is tight and properly positioned before starting the vehicle.

24. The C.A.R.B. exemption sticker, (attached), must be visible under the hood, so the emissions inspector can see it when the vehicle is required to be tested for emissions. California requires testing every two years, other states may vary.

25. It will be necessary for all K&N® high flow intake systems to be checked periodically for realignment, clearance and tightening of all connections. Failure to follow the above instructions or proper maintenance may void warranty.

ROAD TESTING:

1. Start the engine with the transmission in neutral or park, and the parking brake engaged. Listen for air leaks or odd noises. For air leaks secure hoses and connections. For odd noises, find cause and repair before proceeding. This kit will function identically to the factory system except for being louder and much more responsive.

2. Test drive the vehicle. Listen for odd noises or rattles and fix as necessary.

3. If road test is fine, you can now enjoy the added power and performance from your kit.

4. K&N Engineering, Inc., requires cleaning the intake system's air filter element every 100,000 miles. When used in dusty or off-road environments, our filters will require cleaning more often. We recommend that you visually inspect your filter once every 25,000 miles to determine if the screen is still visible. When the screen is no longer visible some place on the filter element, it is time to clean it. To clean and re-oil, purchase our filter Recharger® service kit, part number 99-5050 or 99-5000 and follow the easy instructions.

SOME INTAKE SYSTEMS ARE NOT LEGAL FOR SALE OR USE ON ANY POLLUTION CONTROLLED MOTOR VEHICLE IN CALIFORNIA OR STATES ADOPTING CALIFORNIA EMISSION PROCEDURES.

See knfilters.com for CARB status on each part for a specific vehicle