

Installation Instructions

I - Sheet Number I-B043801A1 Rev.A



Premium Style. Lasting Performance.

For proper installation and best possible fit, please read all instructions BEFORE you begin.
For technical assistance or to obtain missing parts, please call Customer Relations at 1-800-241-7219.

Para una instalación adecuada y el mejor ajuste posible, lea todas las instrucciones ANTES de comenzar.
Para obtener asistencia técnica o para obtener piezas que faltan, por favor llame a Relaciones con el cliente en 1-800-241-7219.

Pour une installation correcte et le meilleur ajustement possible, s'il vous plaît lire toutes les instructions AVANT de commencer.
Pour une assistance technique ou pour obtenir des pièces manquantes, s'il vous plaît communiquer avec les Relations à la clientèle au 1-800-241-7219.

Care and Cleaning

- **Wash only with mild soap & dry with a clean cloth.**
Lavar con jabón suave y seque con un paño limpio.
Laver avec un savon doux et séchez avec un chiffon propre.
- **Every 3 months or 5000 miles check the cover tension and all components for tightness.**
Revise cada 3 meses o 5,000 millas la tensión de la cubierta y todos los componentes estén ajustados.
Vérifiez tous les 3 mois ou 5000 miles la tension couvercle et le serrage des composants.

Congratulations!

You have purchased one of the many quality Lund® branded products offered by Lund International, Inc. We take the utmost pride in our products and want you to enjoy years of satisfaction from your investment. We have made every effort to ensure that your product is top quality in terms of fit, durability, finish and ease of installation.

Usted ha comprado uno de los muchos productos de calidad ofrecidos por Lund® de marca productos ofrecidos por Lund International, Inc. Tomamos el orgullo extremo en nuestros productos y queremos que disfrute durante años de su inversión. Hemos hecho todos los lo posible para que su producto es de calidad superior en cuanto a ajuste, durabilidad, acabado y facilidad de la instalación.

Vous avez acheté un des nombreux produits de qualité offerts par Lund® marque produits offerts par Lund International, Inc Nous sommes extrêmement fiers de nos produits et souhaitons que vous tiriez des années de satisfaction de votre investissement. Nous avons pris toutes les efforts pour s'assurer que votre produit est de qualité supérieure en termes de durabilité, de finition et la facilité de l'installation.

INSTALLATION INSTRUCTIONS

PART# 22678438/ 23078438

PARTS LIST:

Qty	Description	Qty	Description
1	Driver/Left Sidebar	2	12mm x 45mm Double Bolt Plates
1	Passenger/Right Sidebar	4	12mm Plastic Retainers
1	Driver/Left Front Mounting Bracket	6	12mm x 32mm OD x 3mm Flat Washers
1	Passenger/Right Front Mounting Bracket	6	12mm Lock Washers
1	Driver/Left Rear Mounting Bracket	6	12mm Hex Nuts
1	Passenger/Right Rear Mounting Bracket	4	8mm Clip Nuts
4	1/2" x 2" Hex Bolts	8	8-1.25mm x 30mm Hex Bolts
4	1/2" x 1-1/2" x 1/8" Flat Washers	12	8mm x 24mm OD x 2mm Flat Washers
4	1/2" Lock Washers	8	8mm Lock Washers
2	12mm x 40mm Single Bolt Plates	4	8mm Hex Nuts

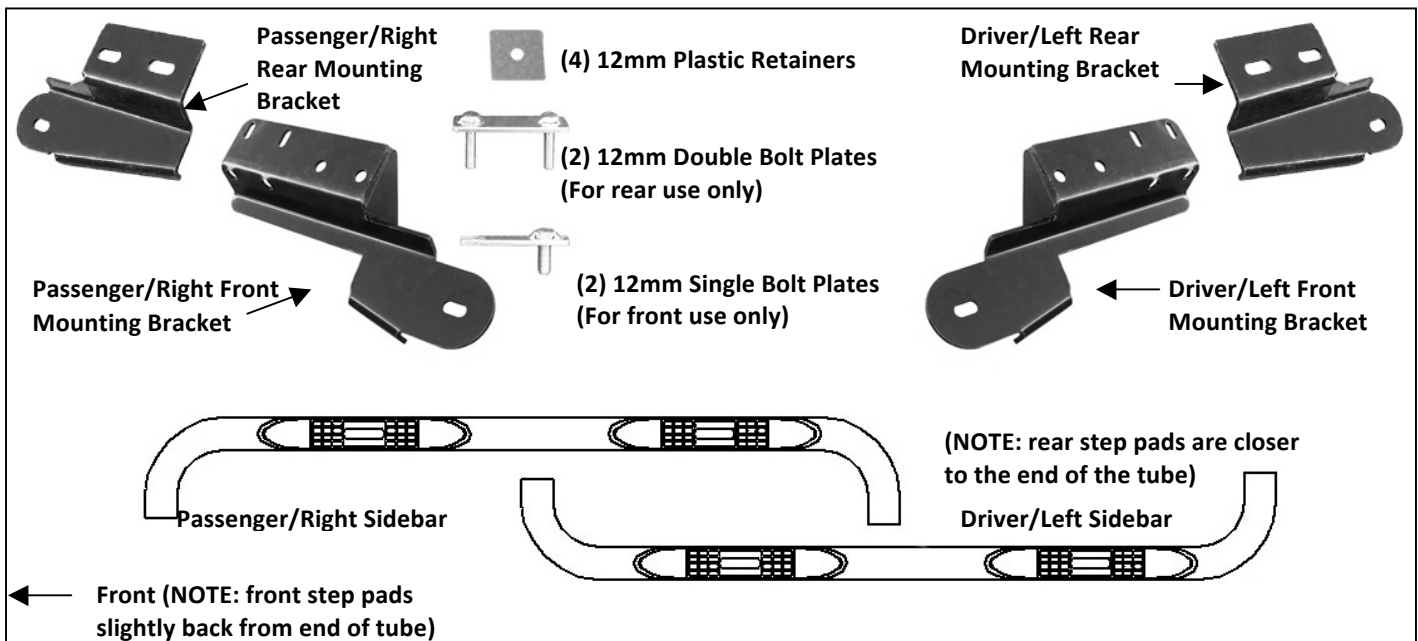

PROCEDURE:

1. REMOVE CONTENTS FROM BOX. VERIFY ALL PARTS ARE PRESENT. READ INSTRUCTIONS CAREFULLY BEFORE STARTING INSTALLATION.
2. Starting at the passenger side-front of the vehicle, locate the round and rectangular openings in the inner body panel. **NOTE:** Mounting holes may be covered with rubber plugs and/or sealing tape. Remove to uncover mounting locations. Insert (2) 8mm Clip Nuts, (with the nut portion to the inside), into the rectangular opening and line up the threaded nut with the factory round holes, **(Figure 1)**. Next, partially thread (1) 12mm Plastic Retainer onto (1) 12mm Bolt Plate, **(Figure 2)**, and insert the Bolt Plate into the large round hole. Once inserted, thread the Plastic Retainer onto the threaded end of the Bolt Plate until it is flush against the body panel. **NOTE:** When properly installed, the Plastic Retainer is designed to prevent the Bolt Plate from falling into the body cavity during Bracket installation.
3. Locate the driver side front Mounting Bracket. Attach the Mounting Bracket to the Bolt Plate with (1) 12mm Flat Washer, (1) 12mm Lock Washer and (1) 12mm Hex Nut, **(Figure 3)**. Do not tighten hardware at this time. Line up the two holes in the Mounting Bracket with the previously installed Nut Clips and secure with (2) 8mm Hex

Bolts, (2) 8mm Flat Washers and (2) 8mm Lock Washers. Do not tighten hardware at this time. Next, line up the two holes in the bottom of the Mounting Bracket with the factory holes in the pinch weld. Attach the Mounting Bracket to the pinch weld using the included (2) 8mm x 30mm Hex Bolts, (2) 8mm Lock Washers, (4) 8mm Flat Washers and (2) 8mm Hex Nuts, **(Figure 3)**. **NOTE:** Insert the Hex Bolt with the Flat Washer up, from the outside-in. Snug all hardware but do not tighten at this time.

4. Moving to the rear, locate the factory large round hole and smaller oval hole in the inner body panel. **NOTE:** Mounting holes may be covered with rubber plugs, insulation or sealing tape, **(Figure 4A)**. Uncover mounting locations. Select (1) 12mm Double Bolt Plate and insert it into the larger round opening and out the smaller oval hole, **(Figure 4A & 4B)**. Next, thread (1) 12mm Plastic Retainer onto the threaded end so that the retainer covers the smaller of the two holes, **(Figure 4A)**. Thread the Retainer all of the way down until tight against the sheet metal. **NOTE:** When properly installed, the Plastic Retainer is designed to prevent the Bolt Plate from falling into the body panel during installation.
5. Select the passenger side Rear Mounting Bracket and attach it to the Double Bolt Plate with (2) 12mm Flat Washers, (2) 12mm Lock Washers and (2) 12mm Hex Nuts, **(Figure 5)**. Snug all hardware but do not tighten at this time.
6. Once the Mounting Brackets are partially installed, carefully unpack and separate the driver and passenger Sidebars. Position the passenger Sidebar up to the Mounting Brackets and secure with the included (2) 1/2" x 2" Hex Bolts, (2) 1/2" Lock Washers, and (2) 1/2" Flat Washers, **(Figure 6)**. Snug but do not tighten at this time.
7. Level and adjust Sidebar and tighten all hardware.
8. Repeat steps 2 – 7 for driver Sidebar installation.
9. Do periodic inspections of the installation to make sure all hardware is secure and tight.

To protect your investment, wax this product after installing. Regular waxing is recommended to add a protective layer over the finish. Do not use any type of polish or wax that may contain abrasives that could damage the finish.

For stainless steel: Aluminum polish may be used to polish small scratches and scuffs on the finish. Mild soap may be used also to clean the Sidebar.

For gloss black finishes: Mild soap may be used to clean the Sidebars.

PASSENGER SIDE INSTALLATION PICTURED

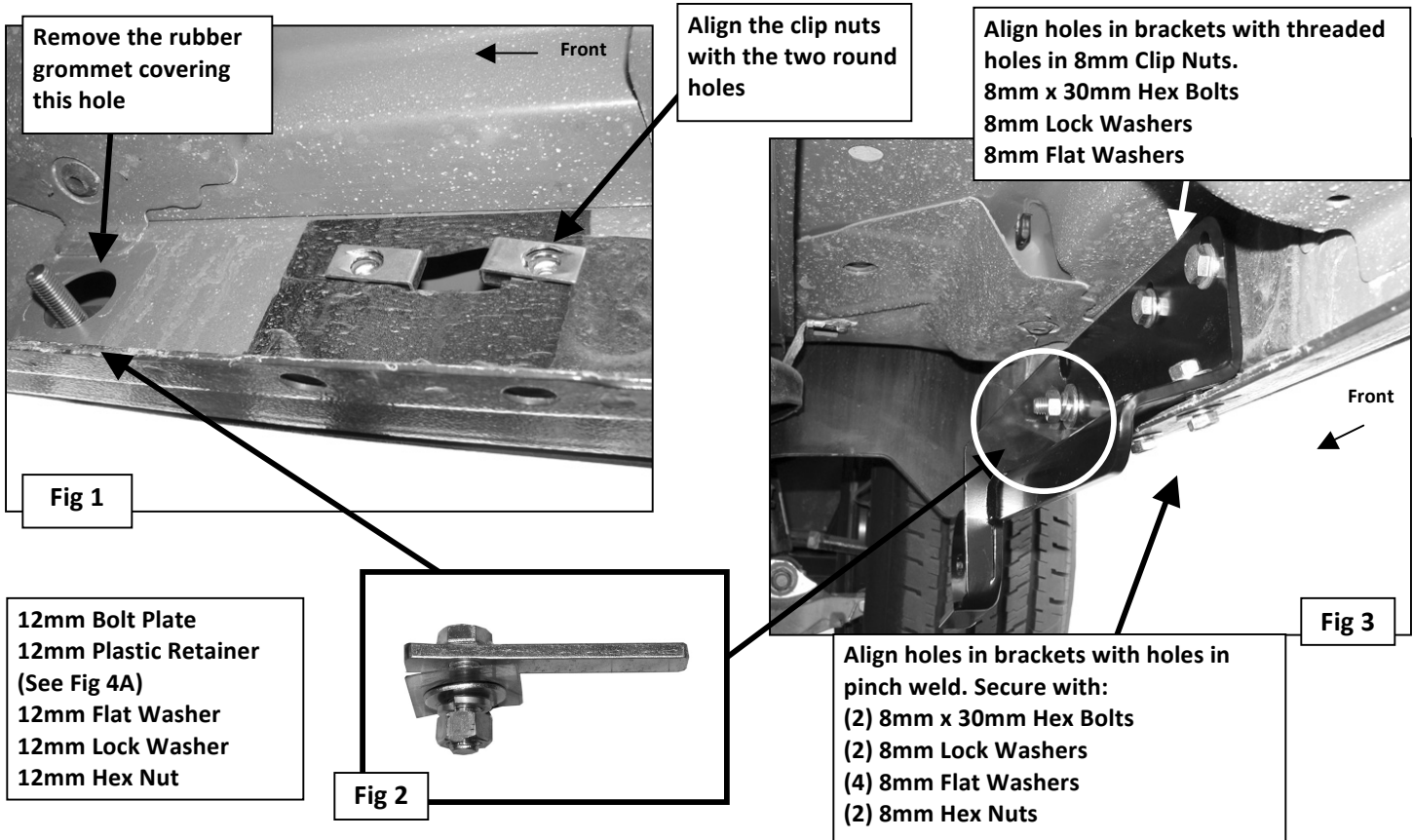

PASSENGER SIDE INSTALLATION PICTURED

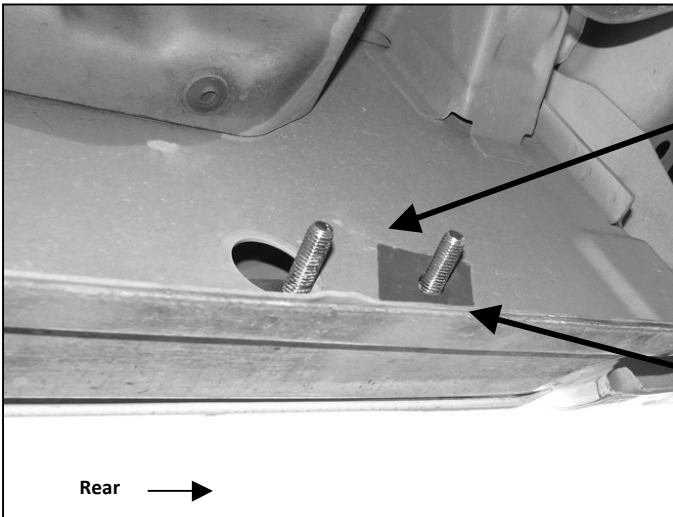

Remove sealing tape and/or rubber grommets to uncover the rear location for the Mounting Brackets



Fig 4B

Insert the 12mm Double Bolt Plate into the large round hole and back out the oval hole. Thread the 12mm Plastic Retainer onto the threaded end and cover the oval hole.

(Fig 4A) Passenger side rear mounting location pictured. Shown with Plastic Retainer in place

- 2) 12mm Flat Washers
- 2) 12mm Lock Washers
- 2) 12mm Hex Nuts

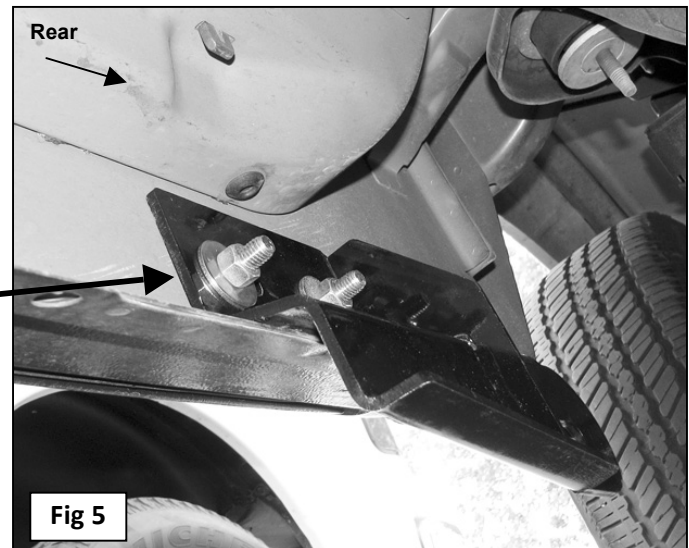

Fig 5

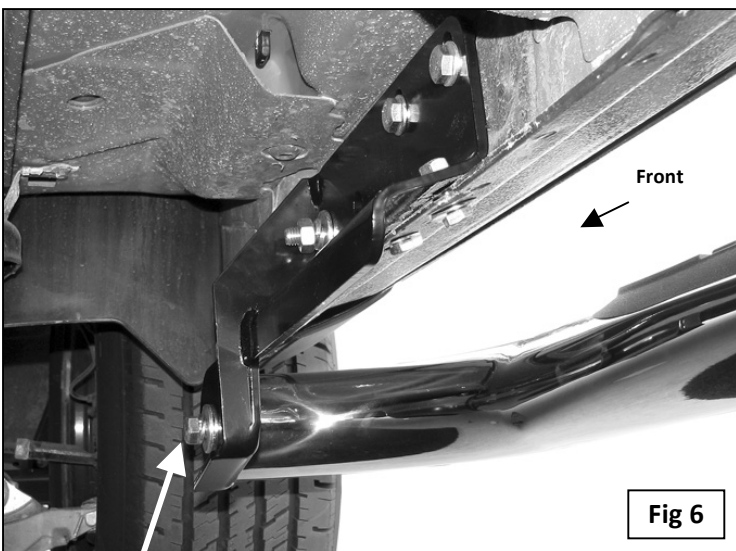

Fig 6

Secure the Sidebar to the Mounting Brackets with:
1/2" x 2" Hex Bolts
1/2" Flat Washers
1/2" Lock Washers