

Installation Instructions

I - Sheet Number I-B077147 Rev. A



Premium Style. Lasting Performance.

For proper installation and best possible fit, please read all instructions BEFORE you begin.
For technical assistance or to obtain missing parts, please call Customer Relations at 1-800-241-7219.

Para una instalación adecuada y el mejor ajuste posible, lea todas las instrucciones ANTES de comenzar.
Para obtener asistencia técnica o para obtener piezas que faltan, por favor llame a Relaciones con el cliente en 1-800-241-7219.

Pour une installation correcte et le meilleur ajustement possible, s'il vous plaît lire toutes les instructions AVANT de commencer.
Pour une assistance technique ou pour obtenir des pièces manquantes, s'il vous plaît communiquer avec les Relations à la clientèle au 1-800-241-7219.

Care and Cleaning

- **Wash only with mild soap & dry with a clean cloth.**
Lavar con jabón suave y seque con un paño limpio.
Laver avec un savon doux et séchez avec un chiffon propre.
- **Every 3 months or 5000 miles check the cover tension and all components for tightness.**
Revise cada 3 meses o 5,000 millas la tensión de la cubierta y todos los componentes estén ajustados.
Vérifiez tous les 3 mois ou 5000 miles la tension couvercle et le serrage des composants.

Congratulations!

You have purchased one of the many quality Lund® branded products offered by Lund International, Inc. We take the utmost pride in our products and want you to enjoy years of satisfaction from your investment. We have made every effort to ensure that your product is top quality in terms of fit, durability, finish and ease of installation.

Usted ha comprado uno de los muchos productos de calidad ofrecidos por Lund® de marca productos ofrecidos por Lund International, Inc. Tomamos el orgullo extremo en nuestros productos y queremos que disfrute durante años de su inversión. Hemos hecho todos los lo posible para que su producto es de calidad superior en cuanto a ajuste, durabilidad, acabado y facilidad de la instalación.

Vous avez acheté un des nombreux produits de qualité offerts par Lund® marque produits offerts par Lund International, Inc Nous sommes extrêmement fiers de nos produits et souhaitons que vous tiriez des années de satisfaction de votre investissement. Nous avons pris toutes les efforts pour s'assurer que votre produit est de qualité supérieure en termes de durabilité, de finition et la facilité de l'installation.

INSTALLATION INSTRUCTIONS

PART# 23275771/ 23475771

PARTS LIST:

1	Driver/Left Sidebar	4	1/2" x 2" Hex Head Bolts
1	Passenger/Right Sidebar	4	1/2" Lock Washers
2	Front Mounting Brackets	4	1/2" ID x 1 1/2" OD x 1/8" Flat Washers
2	Rear Mounting Brackets	4	12mm Lock Washers
1	Driver Side Front Support Bracket	4	12mm x 32mm x 3mm Flat Washers
1	Passenger Side Front Support Bracket	8	10-1.50mm x 35mm Bolt Plates
1	Driver Side Rear Support Bracket (long)	8	10mm Plastic Retainers
1	Passenger Side Rear Support Bracket (long)	8	10mm Lock Washers
4	12-1.75mm x 120mm Gr. 10.9 Hex Bolts	8	10mm ID x 27mm OD x 3mm Flat Washers
4	13mm ID x 68mm OD x 5mm Large Flat Washers	8	10mm Hex Nuts

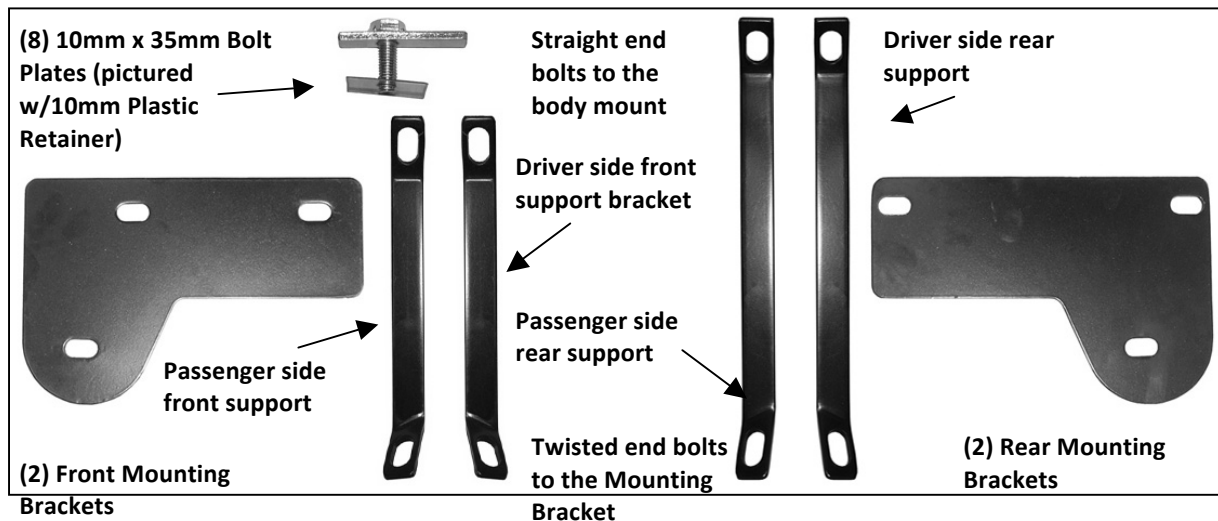

PROCEDURE:

1. REMOVE CONTENTS FROM BOX. VERIFY ALL PARTS ARE PRESENT. READ INSTRUCTIONS CAREFULLY BEFORE STARTING INSTALLATION.
2. From underside of vehicle remove the sealing tape covering the factory holes on the passenger side inner rocker panel, **(Figure 1)**. These are located by the front and rear tire.
3. Thread a Plastic Retainer partially (half way) onto a Bolt Plate, **(Figure 2A)**. Insert the Bolt Plate into the factory slot and twist Bolt Plate to a 45° angle across the opening, **(Figure 2B)**. Once the Bolt Plate is properly installed, hold the threaded end with one hand and tighten the Plastic Retainer against the inner body panel, **(Figure 2C)**. **IMPORTANT:** The Plastic Retainer is designed to prevent the Bolt Plate from falling into the body cavity and to aid Mounting Bracket installation.
4. Repeat Step 3 remaining Bolt Plate installation.
5. Select a front Mounting Bracket and position it onto the previously installed Bolt Plates. Secure it with (2) 10mm Flat Washers, (2) 10mm Lock Washers and (2) 10mm Hex Nuts, **(Figure 3)**.
6. Remove the factory front body mount bolt. Select the passenger front Support Bracket and place the straight bend against body mount. Partially hang Support Bracket with factory body mount bolt **(Figures 4A, 4B & 5)**.

NOTE: The twisted end on the Support Bracket mounts to the Mounting Bracket.

IMPORTANT! Depending on model year, the factory body mount bolt may be too short for proper Support Bracket installation or the factory flat washer may not be removable. If necessary, replace the factory body mount bolts and washers with the supplied 12mm x 120mm Hex Bolts, 13mm x 68mm Large Flat Washers, 12mm x 32mm Flat Washers and 12mm Lock Washers. See Page 3, **(Figure 4B)**, for an example and more information. It is the installer's responsibility to determine the correct hardware for proper installation.

7. Repeat steps 2-6 for rear Mounting Bracket installation.
8. Line up slot in the Support Bracket with the slot in the Mounting Bracket. Position the front of the passenger Sidebar up to the front Mounting Bracket. Secure the Support Bracket and Sidebar to the Mounting Bracket with (1) 1/2" x 2" Hex Bolt, (1) 1/2" Lock Washer and (1) 1/2" Flat Washer, **(Figure 4 & 5)**. Do not tighten at this time. Repeat this step for rear Sidebar mounting.
9. Level and align Sidebar properly and tighten all hardware.
10. Repeat steps 2-9 for driver Sidebar installation.
11. Do periodic inspections to the installation to make sure all hardware is secure and tight.

To protect your investment, wax this product after installing. Regular waxing is recommended to add a protective layer over the finish. Do not use any type of polish or wax that may contain abrasives that could damage the finish.

For stainless steel: Aluminum polish may be used to polish small scratches and scuffs on the finish. Mild soap may be used also to clean the Sidebar.

For gloss black finishes: Mild soap may be used to clean the Sidebar.

Passenger Side Installation Pictured

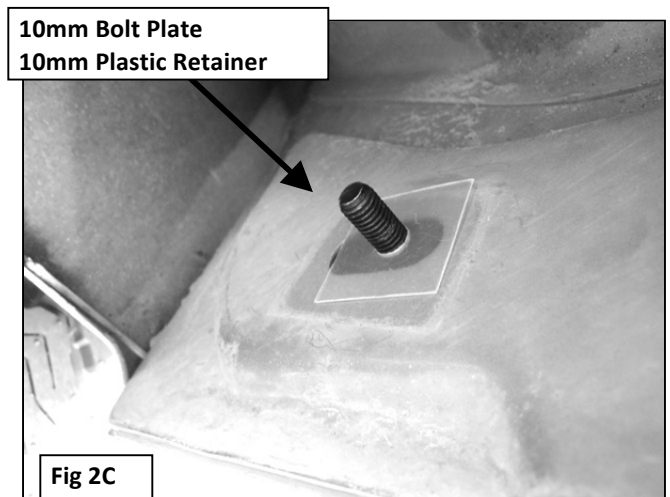
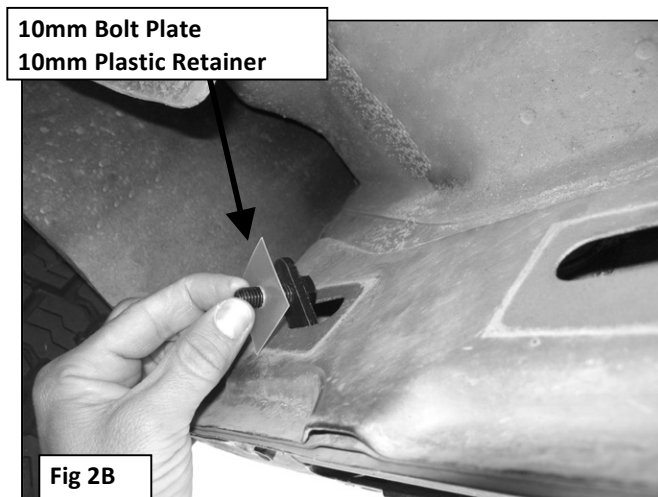
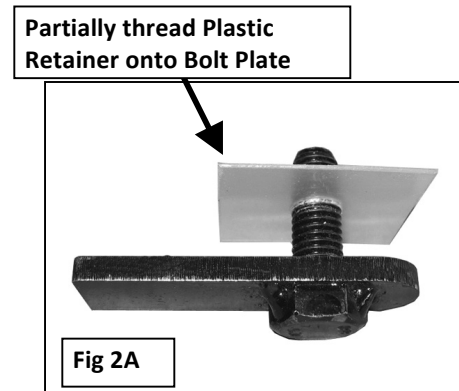
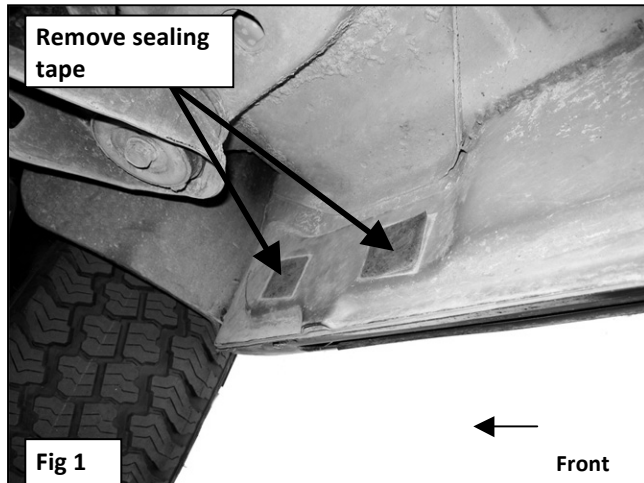

Passenger Side Installation Pictured

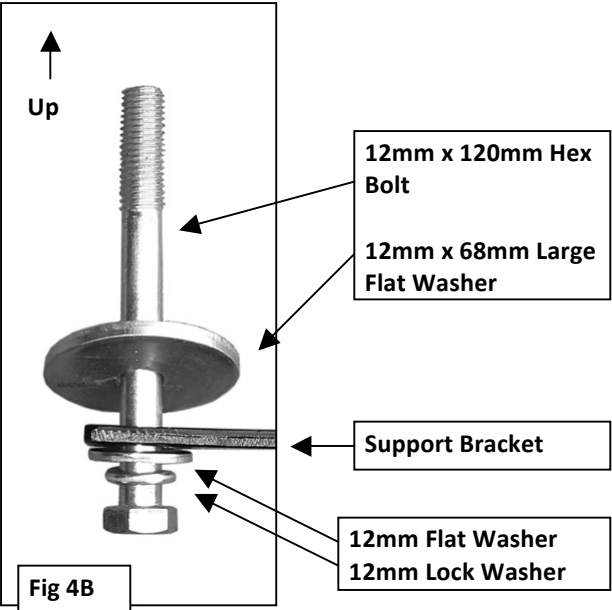
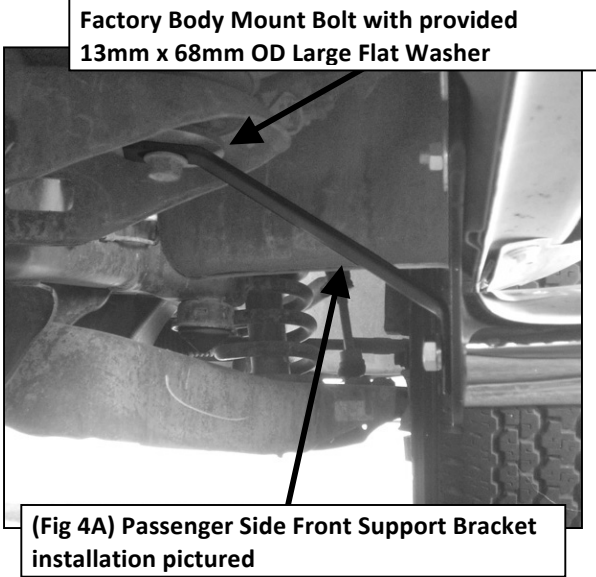
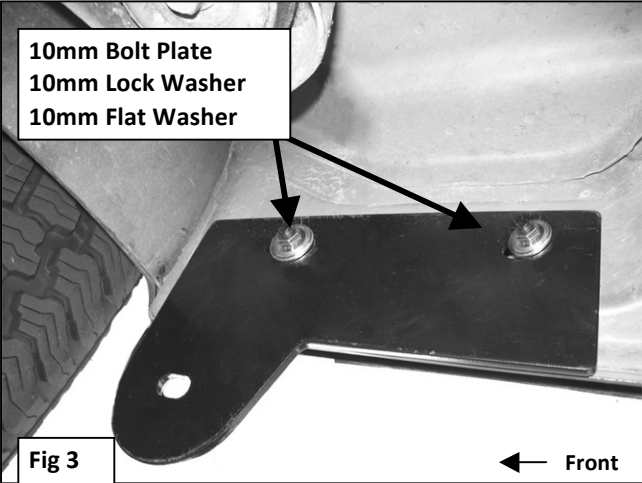

IMPORTANT! Depending on model year, there may not be a factory washer and/or the factory body mount bolt may be too short for proper Support Bracket installation. If necessary, replace the factory body mount bolt and washer, (if washer is not removable), with the provided 12mm x 120mm Hex Bolts, 13mm x 68mm Large Flat Washers, 12mm x 32mm Flat Washers and 12mm Lock Washers. If the factory bolt is long enough but there is no factory washer, use the provided 13mm x 68mm OD Large Flat Washers to mount the Support Brackets, (see Figure 4 & 5). It is the installer's responsibility to determine the correct hardware for proper installation.

Factory Body Mount Bolt with
provided 13mm x 68mm OD Large
Flat Washer

