

Care and Cleaning

- Do not use cleaning solvents of any kind.
- Wash only with mild soap & dry with a clean cloth.

Congratulations!

You have purchased one of many Lund® branded quality parts offered by Lund International, Inc. We take the utmost pride in our products and want you to enjoy years of satisfaction from your investment. We have made every effort to ensure that your product is top quality in terms of fit, durability, finish and ease of installation.



Lund International, Lund Accessories Division
775 Tipton Industrial Drive, Building 2, Suite F
Lawrenceville, GA 30045
800-328-5863 • Fax 800-782-5448 • Visit us at lundinternational.com



© 2004 Lund International, Inc. All rights reserved.
Lund® and the Lund® logo are trademarks of Lund International, Inc.



Interceptor™ Avenger™ X-Terminator™ Wrap Bug Shield

For proper installation and best possible fit, please read all instructions BEFORE you begin. Review the Warranty Card enclosed with this product BEFORE installation of product. For technical assistance or to obtain missing parts, please call Customer Relations at 1-800-328-5863.

Important Safety Information



- To avoid risk of personal injury or property damage:
- Wear safety glasses while installing the Hood Shield.
- Do not use automatic “brush-style” car washes.
- Do not pull on shield to close hood.
- Routinely check security of fasteners.
- Check clearances on vehicle.

Contents

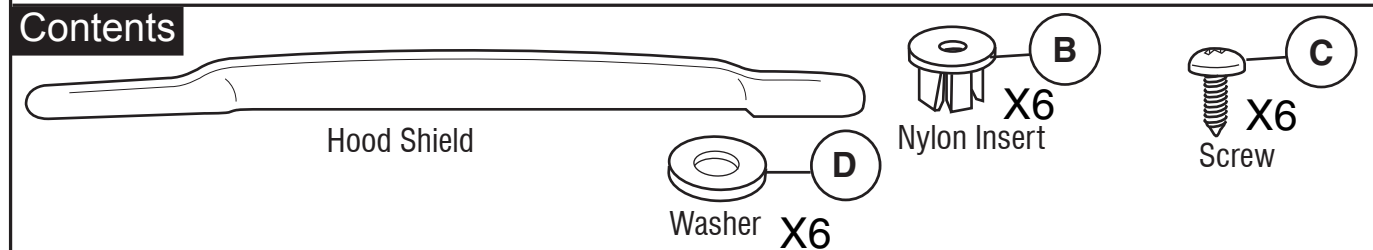

Tools Required

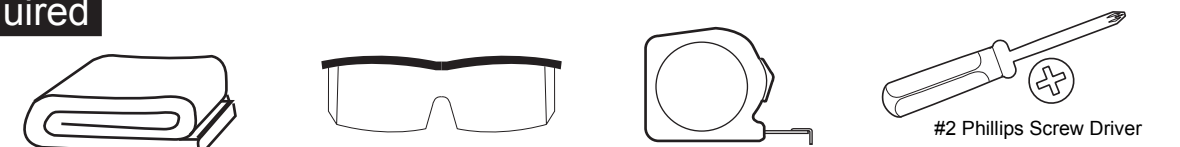

Preparation Before Painting / Installation

Please check fit of parts before painting as we will not accept the return of modified or painted parts. We will not assume any responsibility for parts painted in error. Review the Warranty Card enclosed with the product before you install the product.

Installation Steps Étapes D'Installation
Pasos De la Instalación

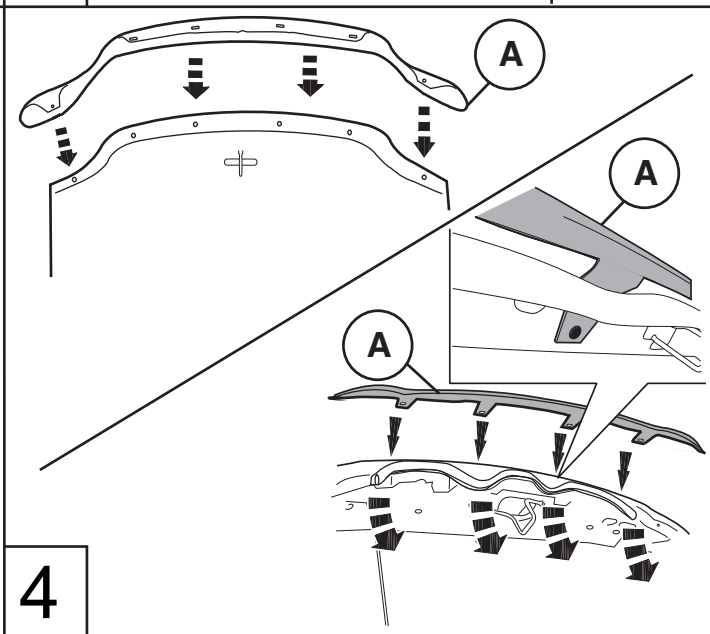
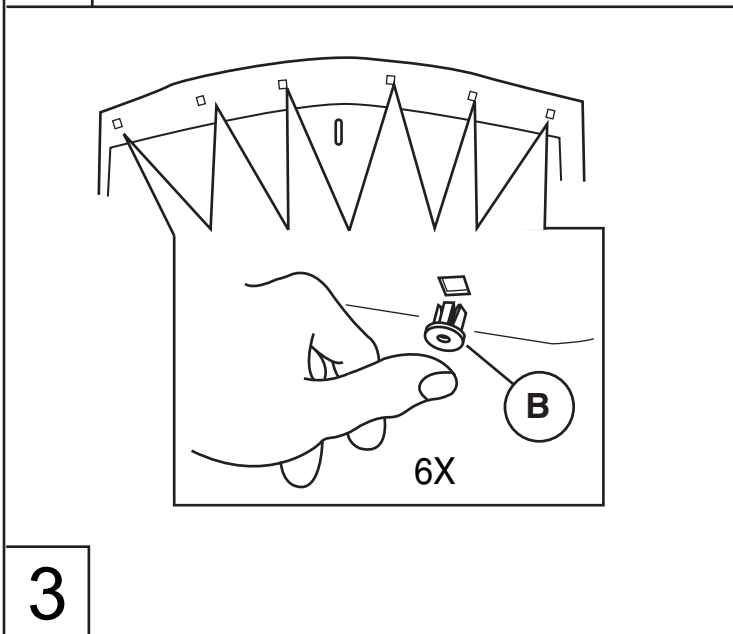
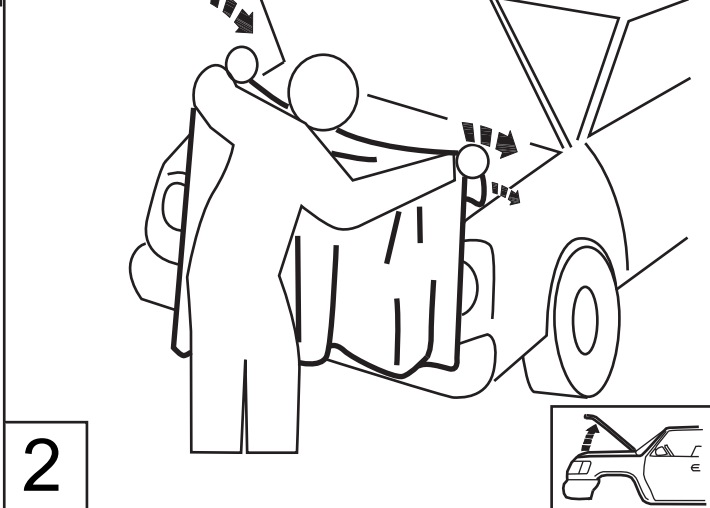
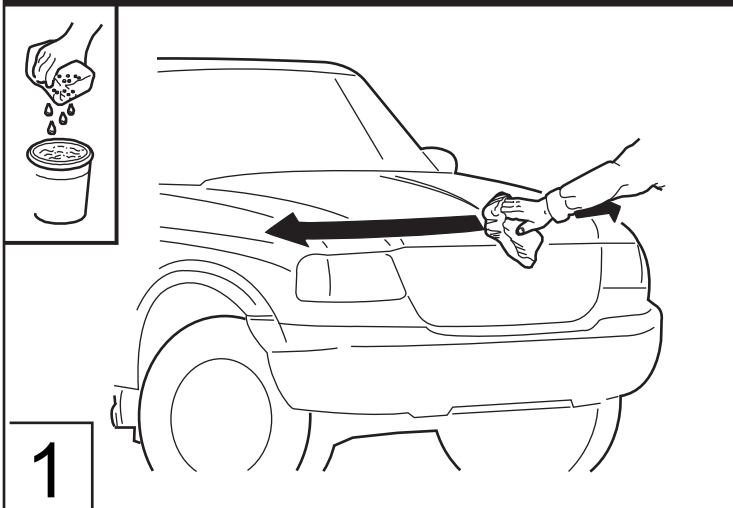

NOTE:
CENTER SHIELD ON HOOD
ESCUDO del CENTRO EN CAPUCHA
Le BOUCLIER du CENTRE SUR CAPUCHON

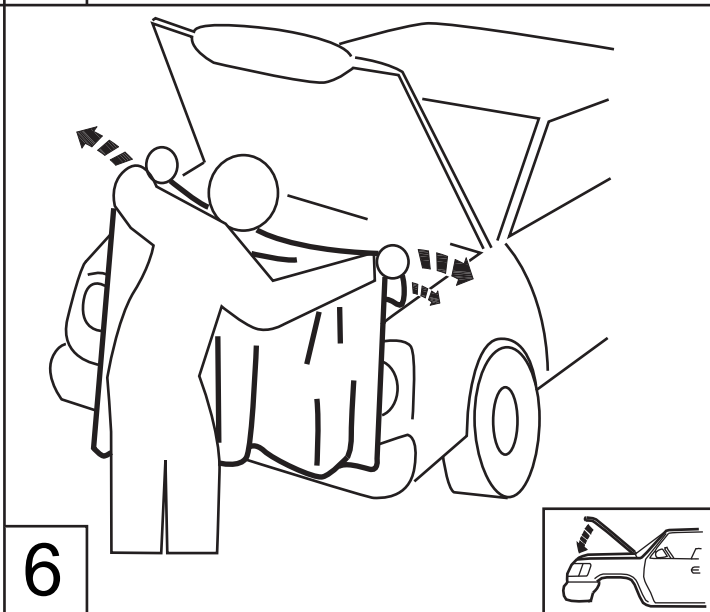
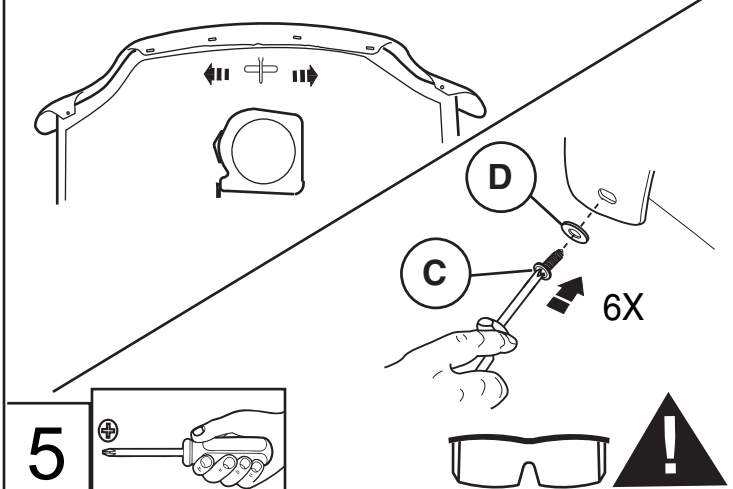

Soin et Nettoyage

- N'employez pas les dissolvants de nettoyage de la sorte.
- Lavez seulement avec du savon doux et séchez avec un tissu propre.

Félicitations!

Vous avez acheté une des nombreuses pièces de qualité marquées par Lund® offertes par Lund international, inc.. Nous prenons la plus grande fierté dans nos produits et voulons que vous appréciiez des années de satisfaction de votre investissement. Nous avons fait tout effort de s'assurer que votre produit est qualité supérieure en termes d'ajustement, longévité, finition et facilité d'installation.



Lund International, Lund Accessories Division
775 Tipton Industrial Drive, Building 2, Suite F
Lawrenceville, GA 30045

800-328-5863 • Fax 800-782-5448 • Visit us at lundinternational.com

© 2004 Lund International, Inc. All rights reserved.

Lund and the Lund logo are trademarks of Lund International, Inc.



Français

Interceptor™ Avenger™ X-Terminator™
Bouclier de Capuchon d'Emballage

Pour nécessaire d'installation et meilleur possible approprié, lisez s'il vous plaît tout le mode d'emploi AVANT que vous commencez.
Passez en revue la carte de garantie incluse avec ce produit AVANT installation de produit.
Pour l'assistance technique ou pour obtenir les pièces absentes, appelez svp les relations de client à 1-800-328-5863.

L'Information Importante De Sûreté

CAUTION
PRECAUCIÓN
ATTENTION

- Pour éviter le risque de blessures ou de dégâts matériels :
- Portez les verres de sûreté tout en installant le bouclier de capot.
- N'employez pas les lavages de voiture automatiques d'"balayer-modèle".
- Ne tirez pas sur le bouclier au capot étroit.
- Vérifiez par habitude le degré de sécurité des attaches.
- Vérifiez les dégagements sur le véhicule.

Contenus

Bouclier De Capot

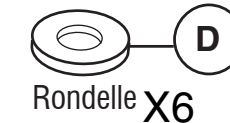

Rondelle X6



Insertion
En nylon

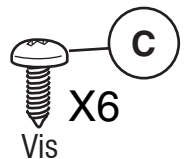

Vis
X6

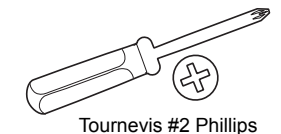
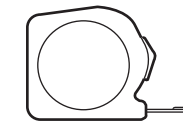
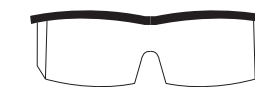
Instruments Voulus

Tournevis #2 Phillips

La Préparation Avant le fait de Peindre / l'Installation

Svp ajustement de contrôle des pièces avant que peignant car nous n'accepterons pas le retour des pièces modifiées ou peintes. Ni assumez n'importe quelle responsabilité des pièces peintes par erreur. Passez en revue la carte de garantie incluse avec le produit avant que vous installiez le produit.

Français

Cuidado y Limpieza

- No utilice los disolventes limpiadores de la clase.
- Lávese solamente con el jabón suave y séquese con un paño limpio.

¡Felicitaciones!

Usted ha comprado uno de los muchos productos calificados Lund® ofrecidos por Lund internacional, inc. de la calidad. Tomamos el orgullo extremo en nuestros productos y quisiéramos que usted gozara de años de la satisfacción de su inversión. Hemos hecho cada esfuerzo de asegurarse de que su producto es calidad superior en términos del ajuste, de la durabilidad, del final y de la facilidad de la instalación.



Lund International, Lund Accessories Division
775 Tipton Industrial Drive, Building 2, Suite F
Lawrenceville, GA 30045
800-328-5863 • Fax 800-782-5448 • Visit us at lundinternational.com



© 2004 Lund International, Inc. All rights reserved.
Lund® and the Lund® logo are trademarks of Lund International, Inc.



Español



Interceptor™ Avenger™ X-Terminator™ Escudo de Capucha de Abrigo

Para instalación apropiada y ataque mejor posible, por favor lea todas las instrucciones **ANTES** de que usted comience.

Repase la tarjeta de la garantía incluida con este producto **ANTES** de la instalación del producto.

Para asistencia técnica u obtener partes ausentes, por favor llame al Servicio de Cliente al 1-800-328-5863.

Información Importante De Seguridad



- Para evitar el riesgo de los daños corporales o de los daños materiales:
- Use las gafas de seguridad mientras que instala el protector de la capilla.
- No utilice las coladas automáticas del coche del "cepillar-estilo".
- No tire en el protector a la capilla cercana.
- Compruebe rutinariamente la seguridad de sujetadores.
- Compruebe las separaciones en el vehículo.

Contenido

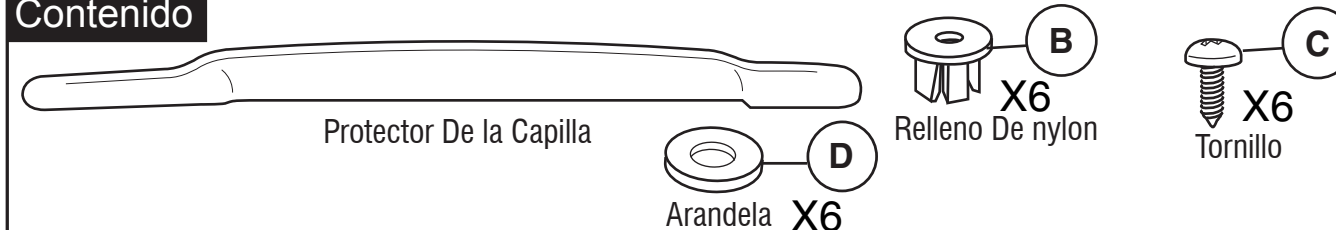

Instrumentos Requeridos

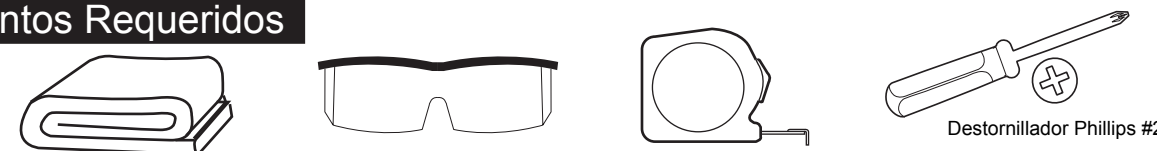

Preparación Antes de Pintar / Instalación

Por favor ajuste del cheque de piezas antes de que pinte pues no aceptaremos la vuelta de piezas modificadas o pintadas. No asumiremos ninguna responsabilidad de las piezas pintadas en error. Repase la tarjeta de la garantía incluida con el producto antes de que usted instale el producto.

Español