

# Installation Instructions

I - Sheet Number I-1163 Rev.B



## Interceptor™

For proper installation and best possible fit, please read all instructions **BEFORE** you begin.  
For technical assistance or to obtain missing parts, please call Customer Relations at 1-800-328-5863.

### Important Safety Information



- CAUTION - Before driving, ensure that the hood shield is properly anchored to vehicle.
- Do not use automatic "brush-style" car washes.
- Do not use cleaning solvents of any kind.
- Periodically check all components for tightness.

### Contents **NOTE:** Actual product may vary from illustration.



Hood shield



Screw x2



Bracket x2



Fastener x2



Protective Film x2



Alcohol Pad



Pin x5 (2008 Sequoia and  
2010 Tundra ONLY)

### Tools Required



Car Wash Supplies

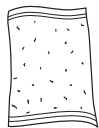

Clean Towel

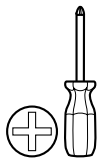

Phillips screwdriver



10mm Nut Driver

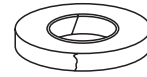

Masking tape



Putty Knife

### Preparation Before Painting / Installation

- A trial fit is recommended to ensure proper positioning and fit.
- Check fit of parts before painting as we will not accept the return of modified or painted parts.
- Wash and dry your vehicle to remove any debris and/or dirt from the installation area.

### Installation Steps **NOTE:** Actual application may vary slightly from illustrations.

#### **NOTE: Steps 1 - 3 2007-2009 Tundra ONLY**

Locate the plastic applique on the grill.

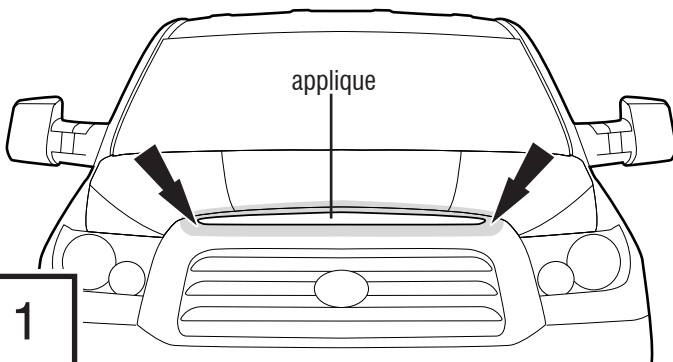

1

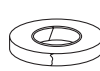

Mask surrounding area with tape, and use a putty knife to carefully pry the plastic applique away from the grill. Begin by lifting up the bottom drivers side corner and work your way across to the bottom passenger side corner. Remove applique.

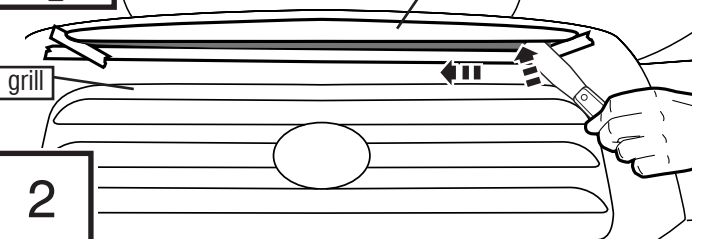

2

# Installation Steps

**NOTE:** Actual application may vary slightly from illustrations.



With the applique removed, use a 10mm nut driver to remove the (5) exposed bolts.

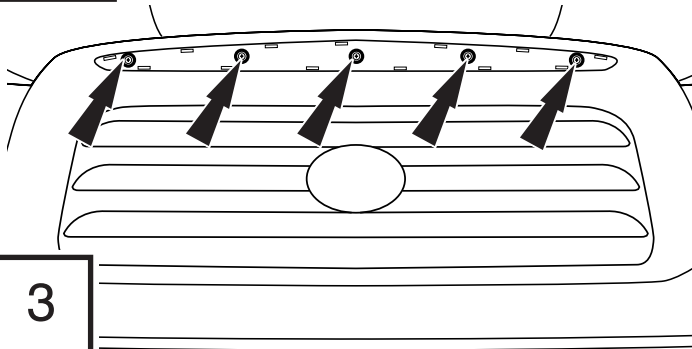

3

Carefully raise hood.

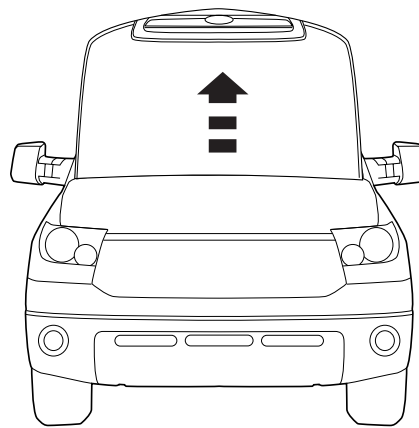

4

Reach under the hood to the backside of the grill and disconnect the hood lock rod from the grill by releasing the lock mechanism and gently lifting the rod away from grill.

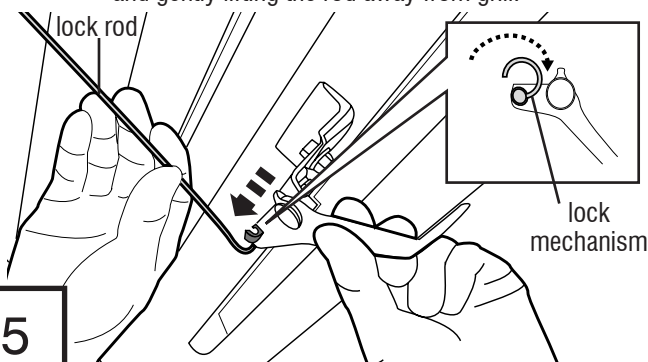

5



Reach under the hood to the backside of the grill, and using a nut driver remove (10) nuts.

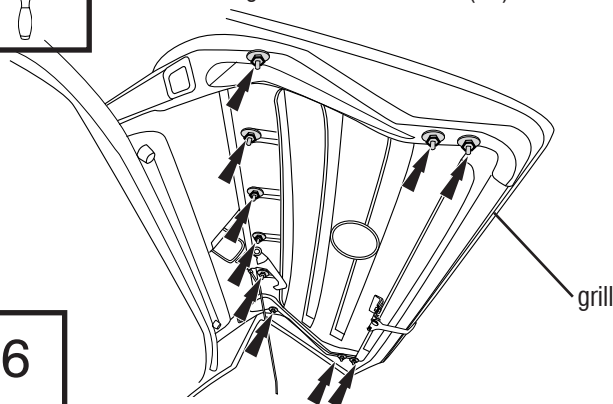

6

Carefully lower hood.

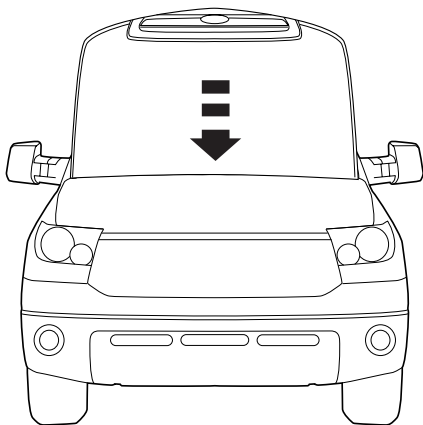

7



Mask area with tape. Starting on the driver side top corner of the grill, and then the passenger side, use the putty knife to carefully pry the grill loose from the hood. Set grill aside.

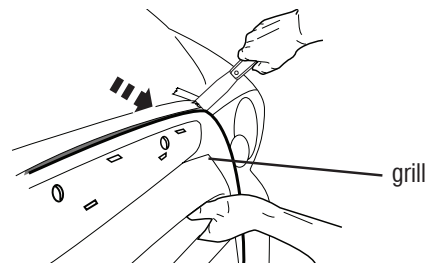
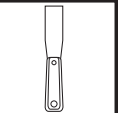

8

**NOTE:** The grill will make a "popping" noise as it separates from the vehicle. This is normal.



Clean front of hood edge, and carefully raise hood.

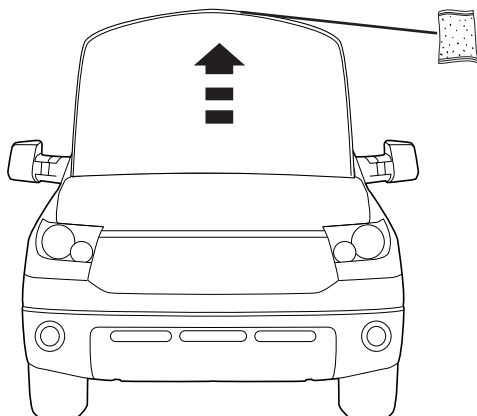

9

Test fit hood shield to hood, and locate the outboard holes on the hood shield and the corresponding outboard holes in hood.

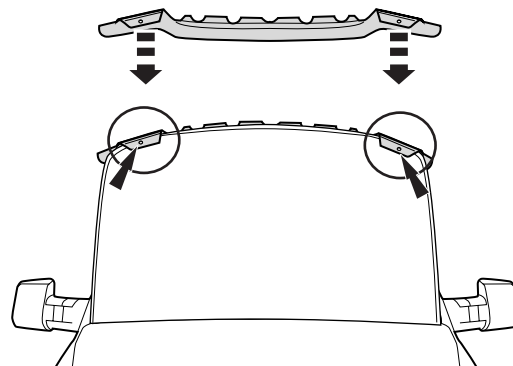

10

# Installation Steps

**NOTE:** Actual application may vary slightly from illustrations.



Clean two (2) outboard holes in the hood with alcohol pad and allow to dry.

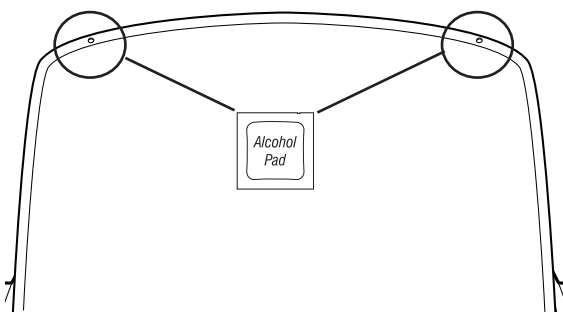

11

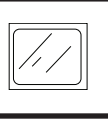

Wrap protective film over edge of hood as shown.

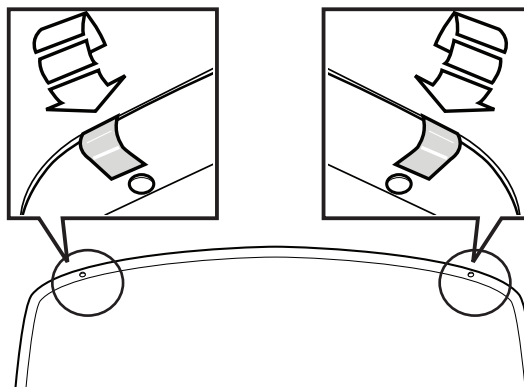

12

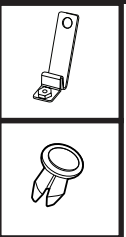

Attach two (2) brackets to hood using two (2) fasteners.

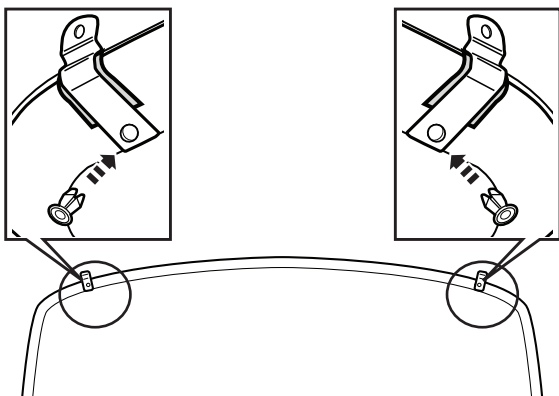

13

Carefully lower hood.

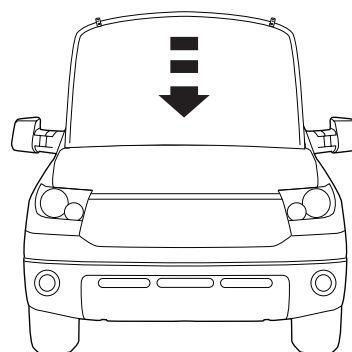

14

Align hood shield with hood edge. Ensure that holes in hood shield aligns with upper holes in bracket

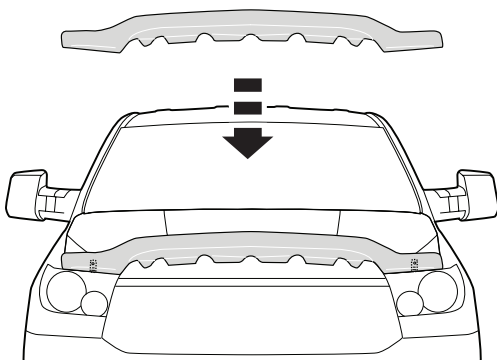

15

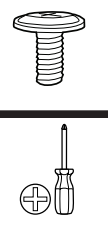

Attach hood shield to **both** brackets using screws.

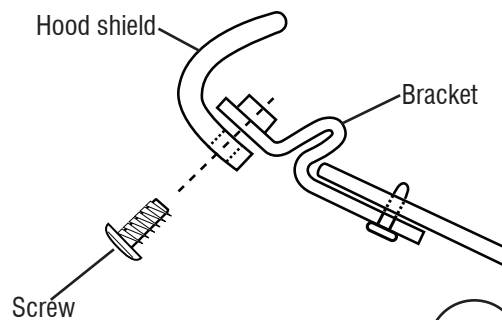

16

**NOTE:** DO NOT over tighten

**X2**

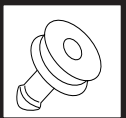

**NOTE: 2008 - up Sequoia and 2010 - up Tundra ONLY**

Replace (5) existing white pins on backside of grill with longer pins included in kit.

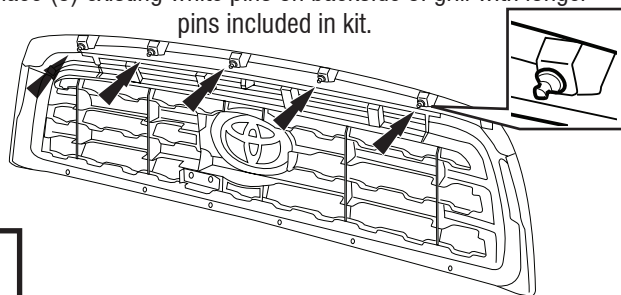

17

Reinstall grill by aligning with holes in hood edge. Ensure that the hood shield is **BETWEEN** the grill and the hood.

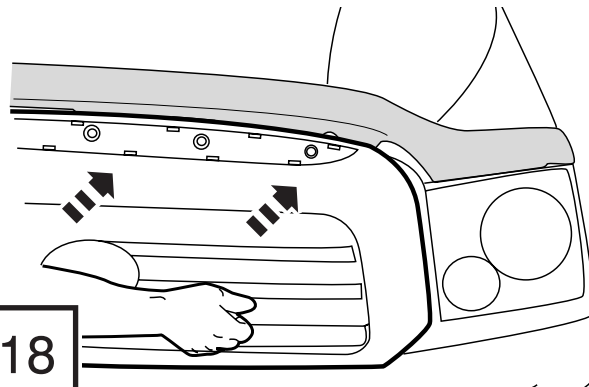

18

## Installation Steps

**NOTE:** Actual application may vary slightly from illustrations.

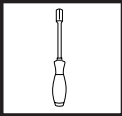

### **NOTE: 2007-2009 Tundra ONLY**

Reattach the grill by reinstalling (5) bolts previously removed.

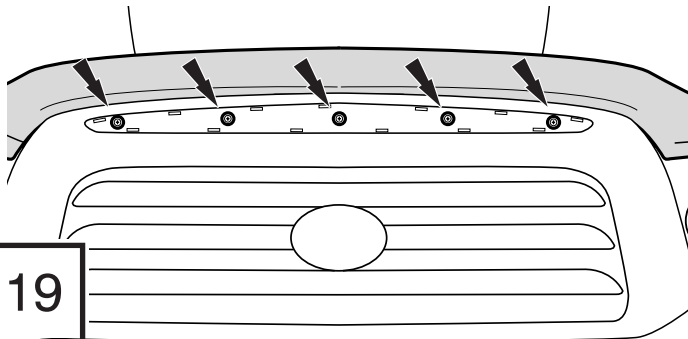

Carefully raise hood.

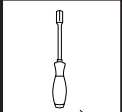
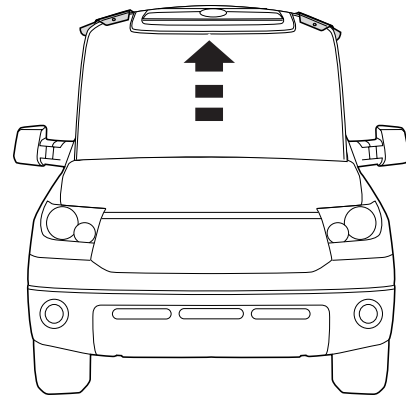

Reach under the hood to the backside of the grill, and reinstall (10) nuts previously removed.

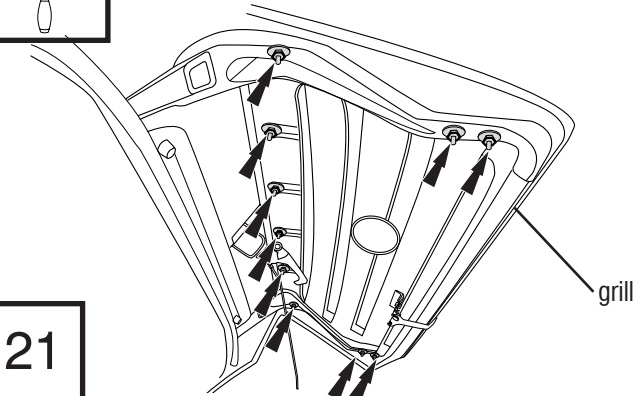

Reach under the hood to the backside of the grill and reattach the hood lock rod to the grill.

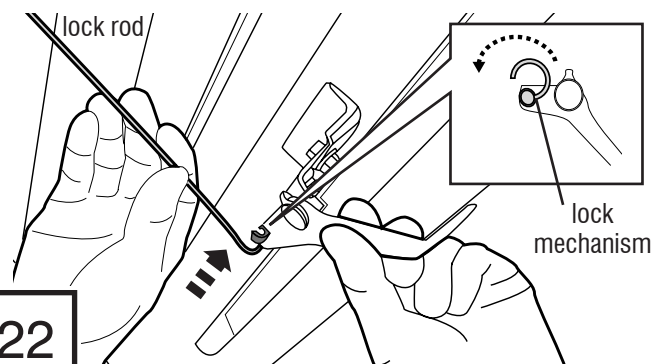

Carefully close hood.

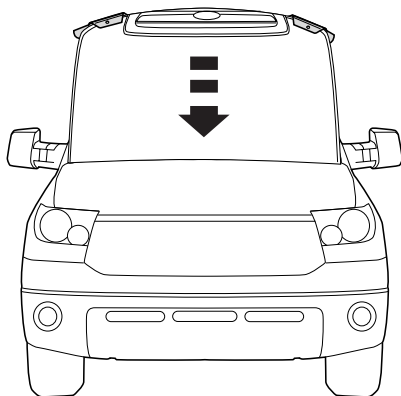

### **NOTE: 2007-2009 Tundra ONLY**

Carefully reinstall the previously removed applique. Slide the top clips in first, then press firmly to snap remaining tabs into place.

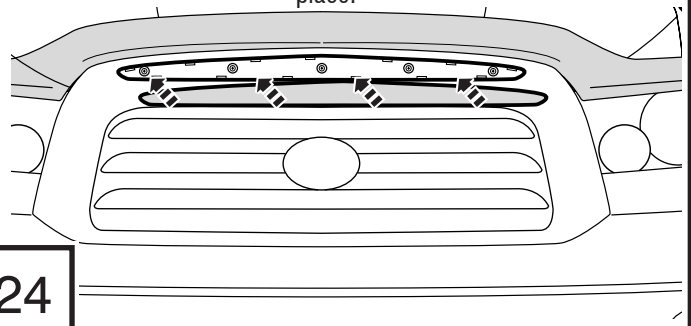

## Care and Cleaning

- Wash only with mild soap & dry with a clean cloth.

## Congratulations!

You have purchased one of the many quality Lund<sup>®</sup> branded products offered by Lund International, Inc. We take the utmost pride in our products and want you to enjoy years of satisfaction from your investment. We have made every effort to ensure that your product is top quality in terms of fit, durability, finish and ease of installation.



Lund International, Lund Accessories Division  
4325 Hamilton Mill Rd. Suite 400, Buford, GA 30518  
800-328-5863 • Visit us at [lundinternational.com](http://lundinternational.com)

© 2011 Lund International, Inc. All rights reserved.  
Lund<sup>®</sup> and the Lund<sup>®</sup> logo are trademarks of Lund International, Inc.





## Interceptor™

**Veillez lire l'ensemble des instructions AVANT d'utiliser le produit afin de garantir une installation correcte et un ajustement optimal. Pour obtenir une assistance technique ou demander des pièces manquantes, veuillez appeler le service clientèle au 1-800-328-5863.**

### Consignes de sécurité importantes



- **PRÉCAUTION** - Avant de conduire, vérifiez que le bouclier du capot est bien ancré au véhicule.
- N'utilisez pas les postes de lavage à brosses.
- N'utilisez pas de solvants lors du lavage.
- Vérifiez régulièrement que les composants sont bien fixés.

### Contenu **REMARQUE :** Le produit réel peut différer du modèle illustré.



Protection de capot



2 vis

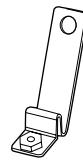

2 supports



2 fixations



2 films protecteurs



Coussinet d'alcool

5 broches (2008 Sequoia et 2010 Tundra UNIQUEMENT)

### Outils nécessaires



équipement de nettoyage

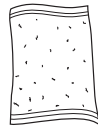

Chiffon propre

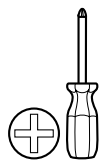

Tournevis Phillips



Tourne-écrou de 10 mm



Ruban-cache



Couteau à mastiquer

### Préparation avant la peinture/installation

- Effectuez d'abord un essai afin de vous assurer que le produit s'adapte à votre véhicule.
- Vérifiez que les pièces peuvent être correctement mises en place avant de peindre car nous n'acceptons pas le retour de pièces modifiées ou peintes.
- Lavez et séchez votre véhicule pour retirer tout débris et/ou saleté de la zone d'installation.

### Étapes de l'installation

**REMARQUE :** L'installation réelle peut différer légèrement des illustrations.

**REMARQUE :** Étapes 1 - 3 Tundra 2007-2009 UNIQUEMENT

Repérez l'applique en plastique sur la grille.

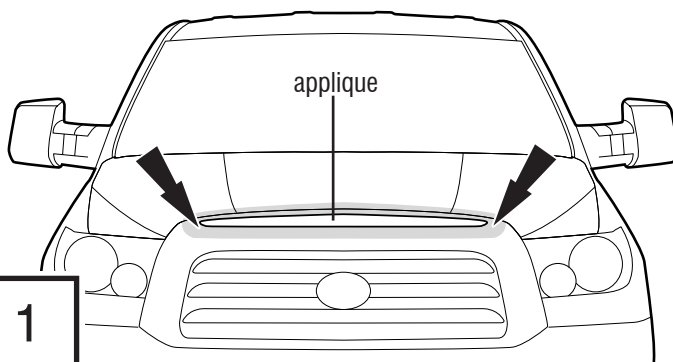

1

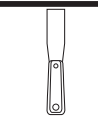

Protégez la zone environnante avec du ruban et utilisez un couteau à mastiquer pour ôter l'applique en plastique de la grille, en faisant levier. Commencez en levant le coin inférieur côté conducteur et poursuivez jusqu'au coin inférieur côté passager. Retirez l'applique.

grille

applique

2

## Étapes de l'installation

**REMARQUE :** L'installation réelle peut différer légèrement des illustrations.



Avec l'applique déposée, utilisez un tourne-écrou de 10 mm pour retirer les (5) boulons exposés.

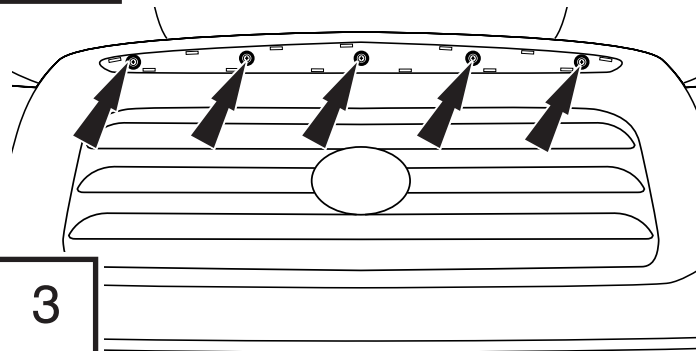

3

Relevez soigneusement le capot.

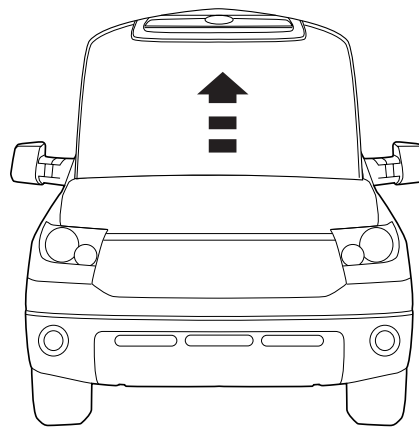

4

En passant par le dessous du capot et vers l'arrière de la grille, débranchez la tige de verrouillage du capot de la grille en relâchant le mécanisme de verrouillage et en levant doucement la tige, à l'écart de la grille.

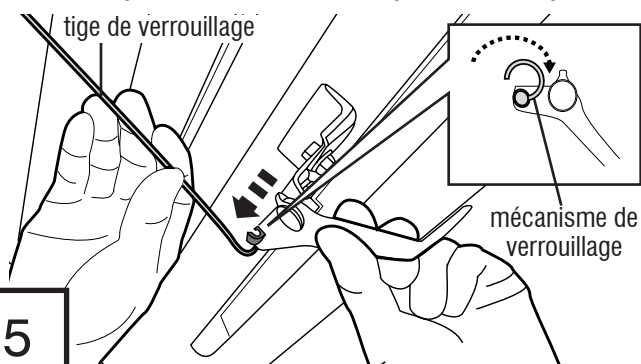

5



En passant par le dessous du capot et vers l'arrière de la grille et en utilisant un tourne-écrou, retirez (10) écrous.

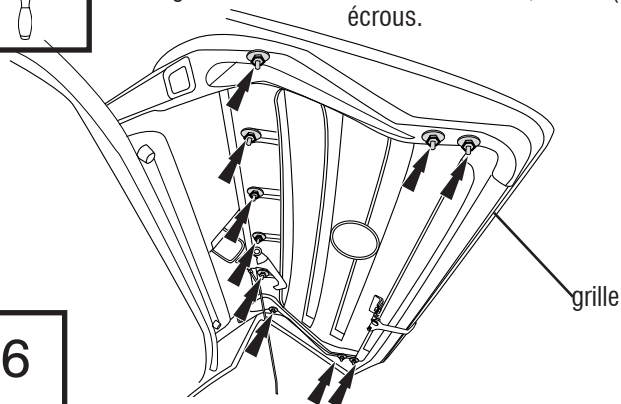

6

Abaissez soigneusement le capot.

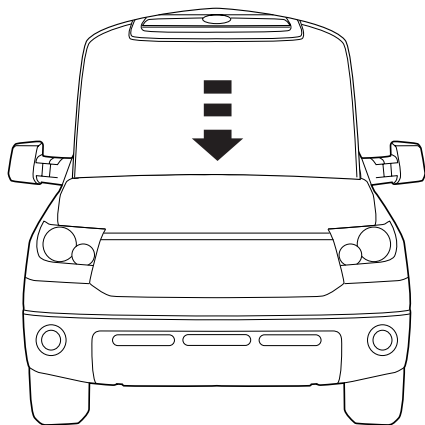

7



Protégez la zone avec du ruban. En commençant depuis le coin supérieur côté conducteur de la grille, puis avec le côté passager, utilisez le couteau à mastiquer pour libérer avec soin la grille du capot, en faisant lever. Mettez la grille de côté.

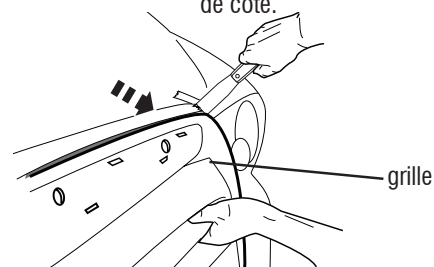
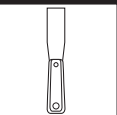

8

**REMARQUE :** La grille fera un bruit sec lorsqu'elle se séparera du véhicule. Ceci est normal.



Nettoyez l'avant du rebord du capot, et levez soigneusement le capot.

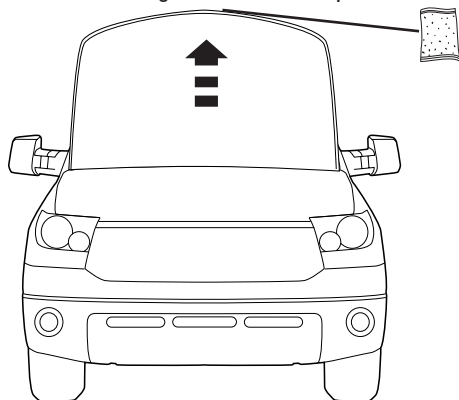

9

Simulez le montage du bouclier de capot sur le capot, et repérez les trous extérieurs sur le bouclier de capot et les trous extérieurs correspondants dans le capot.

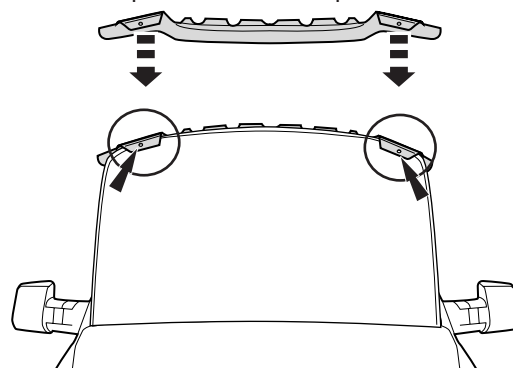

10



# Étapes de l'installation

**REMARQUE :** L'installation réelle peut différer légèrement des illustrations.

**11**

Nettoyez deux (2) trous extérieurs du capot avec le coussinet d'alcool et laissez sécher.

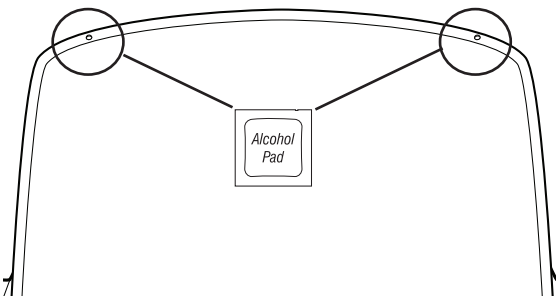

**12**

Emballiez le rebord du capot de film protecteur comme illustré.

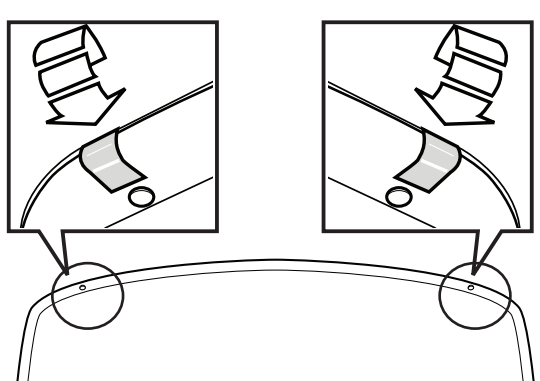

**13**

Attachez deux (2) supports au capot à l'aide de deux (2) fixations.

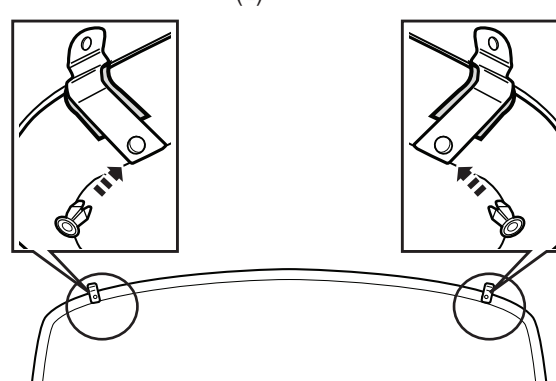

**14**

Abaissez soigneusement le capot.

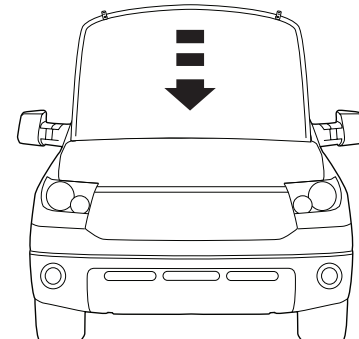

**15**

Alignez le bouclier de capot avec le rebord du capot. Assurez-vous que les trous dans le bouclier de capot sont alignés avec les trous supérieurs du support

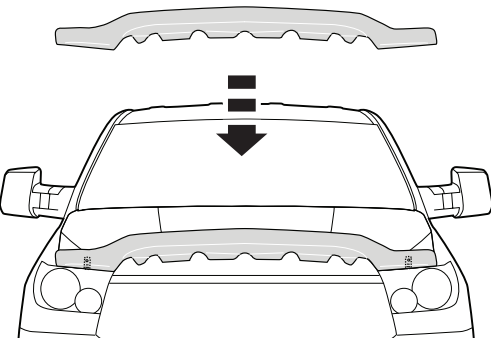

**16**

Attachez le bouclier de capot aux deux supports à l'aide de vis.

Protection de capot

Support

Vis

**REMARQUE :** NE PAS serrer à l'excès

**X2**

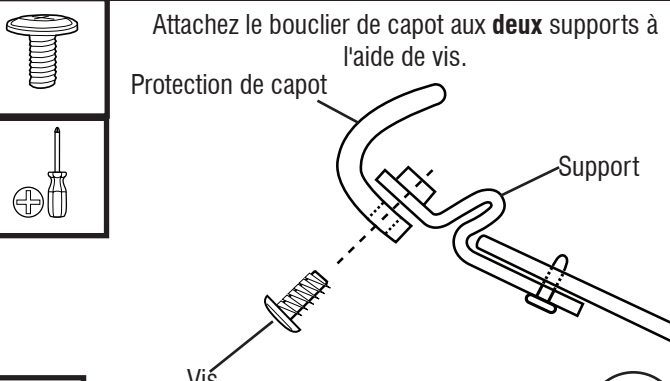

**17**

**REMARQUE :** Véhicules Sequoia 2008 et ultérieurs et Tundra 2010 et ultérieurs **UNIQUEMENT**

Remplacez (5) broches blanches existantes au dos de la grille avec des broches plus longues incluses dans le kit.

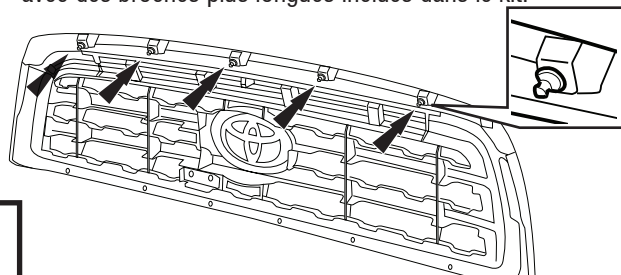

**18**

Réinstallez la grille en l'alignant avec les trous sur le rebord du capot. Assurez-vous que le bouclier de capot est bien **ENTRE** la grille et le capot.

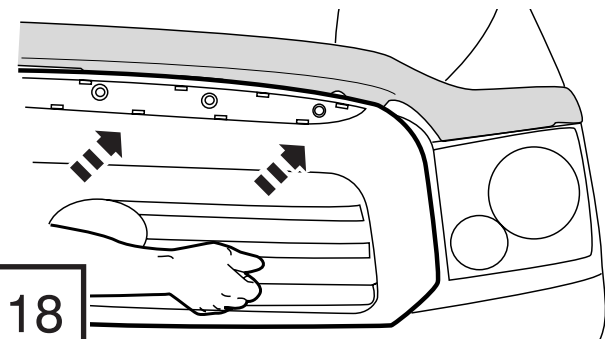

## Étapes de l'installation

**REMARQUE :** L'installation réelle peut différer légèrement des illustrations.

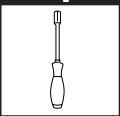

**REMARQUE :** Tundra 2007-2009 **UNIQUEMENT**

Refixez la grille en réinstallant (5) boulons déposés antérieurement.

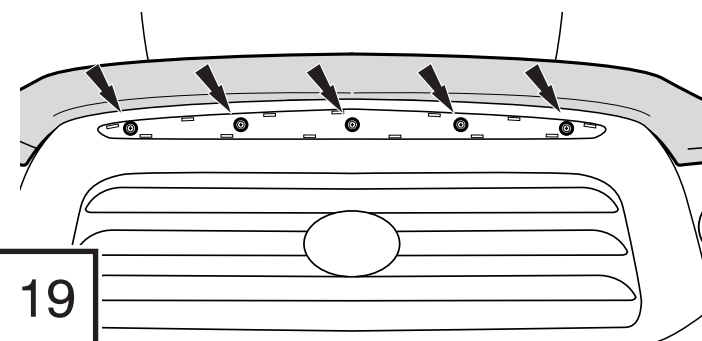

Relevez soigneusement le capot.

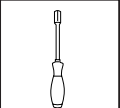
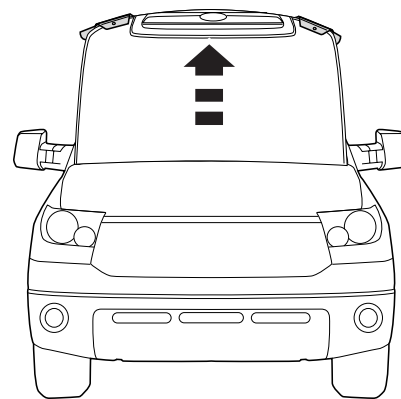

En passant par le dessous du capot et vers l'arrière de la grille, réinstallez (10) écrous déposés antérieurement.

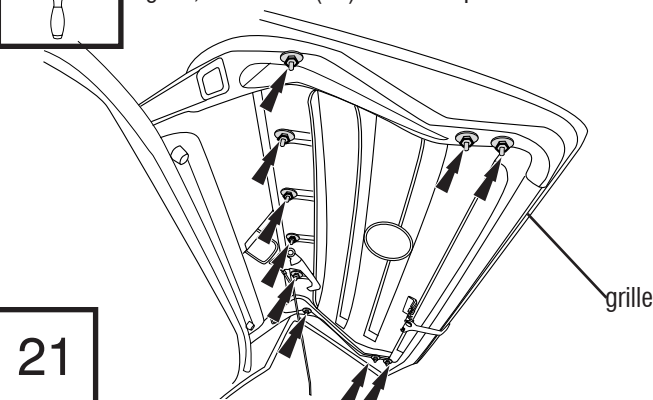

En passant par le dessous du capot et vers l'arrière de la grille, refixez la tige de verrouillage du capot sur la grille.

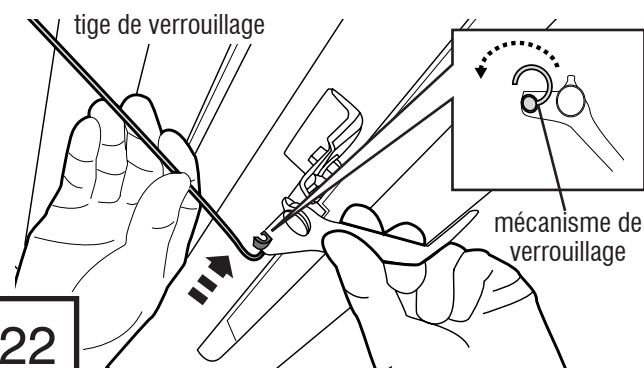

Fermez soigneusement le capot.

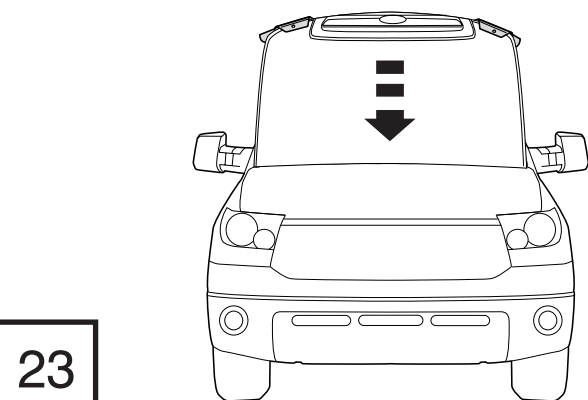

**REMARQUE :** Tundra 2007-2009 **UNIQUEMENT**

Réinstallez soigneusement l'applique précédemment déposée. Faites d'abord glisser les agrafes supérieures, puis appuyez fermement pour remettre les languettes restantes en place.

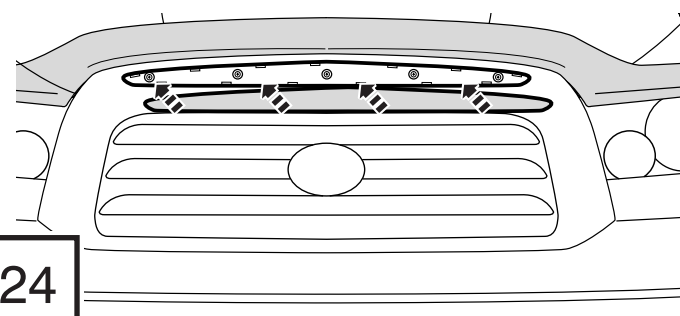

## Entretien et nettoyage

- Utilisez uniquement un détergent doux pour le nettoyage et séchez à l'aide d'un chiffon propre.

## Félicitations !

Vous venez d'acheter un des nombreux produits de qualité de la marque Lund<sup>®</sup> fabriqués par Lund International, Inc. Nous sommes extrêmement fiers de la qualité de nos produits et nous espérons que vous profiterez de cet investissement de longues années durant. Nous nous efforçons d'offrir la meilleure qualité en termes d'ajustement, de finition, de durabilité et de facilité d'installation.



Lund International, Lund Accessories Division  
4325 Hamilton Mill Rd. Suite 400, Buford, GA 30518  
800-328-5863 • Visitez notre site Web [lundinternational.com](http://lundinternational.com)

© 2011 Lund International, Inc. Tous droits réservés.  
Lund<sup>®</sup> et le logo Lund<sup>®</sup> sont des marques déposées de Lund International, Inc.







## Interceptor™

Para la instalación correcta y el mejor ajuste posible, lea las instrucciones ANTES de comenzar.  
Para pedir asistencia técnica u obtener las partes que faltan, llame a Atención al Cliente al 1-800-328-5863.

### Información importante de seguridad



- ADVERTENCIA: Antes de conducir, asegúrese que la cubierta del capó esté debidamente sujeta al vehículo.
- No use servicios automáticos de limpieza de vehículos que utilizan cepillos.
- No use solventes para limpieza de ningún tipo.
- Compruebe periódicamente que todos los componentes estén ajustados.

### Contenido **NOTA:** El producto real tal vez no sea igual a la ilustración.



Cubierta del capó



Tornillo x2



Sujetador x2



Soporte x2



Película protectora x2



Paño con alcohol



Pasador x5 (SÓLO Sequoia 2008 y Tundra 2010)

### Herramientas necesarias



Equipo de limpieza de vehículos



Toalla limpia

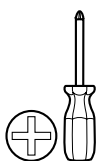

Destornillador Phillips



Llave para tuercas de 10 mm

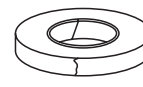

Cinta de enmascarar



Escariador

### Preparación antes de pintar / instalar

- Se recomienda realizar un ajuste de prueba para garantizar el posicionamiento y ajuste correctos.
- Compruebe que las piezas se ajusten correctamente antes de pintarlas, ya que no aceptaremos la devolución de piezas modificadas o pintadas.
- Lave y seque su vehículo para quitar cualquier desecho o suciedad del área de instalación.

### Pasos de instalación **NOTA:** La aplicación real tal vez no sea igual a las ilustraciones.

#### **NOTA: Pasos 1 a 3 SÓLO Tundra 2007-2009**

Encuentre el aplique de plástico en la parrilla.

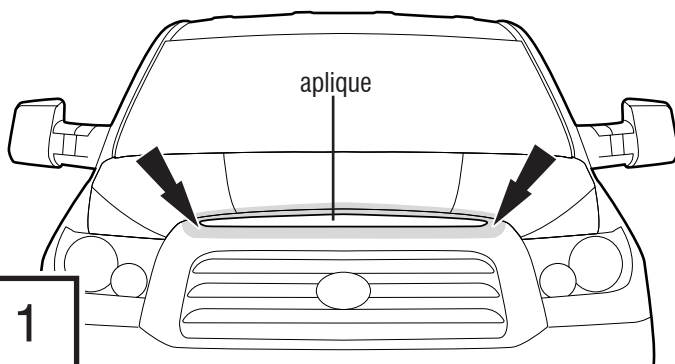

1

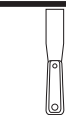

Enmascare el área circundante con cinta y, con un escariador, apalanque el aplique de plástico para retirarlo de la parrilla. Para comenzar, levante la esquina inferior del lado del conductor y continúe hacia la esquina inferior del lado del pasajero. Retire el aplique.

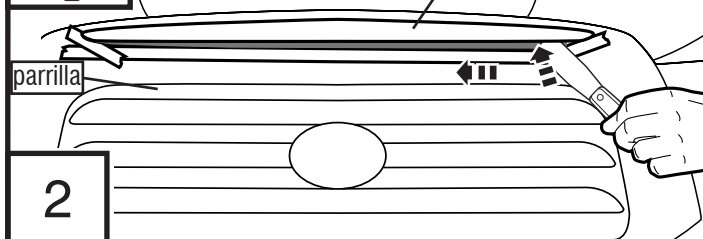

2

# Pasos de instalación

**NOTA:** La aplicación real tal vez no sea igual a las ilustraciones.



Una vez retirado el aplique, utilice una llave para tuercas de 10 mm para extraer los (5) tornillos expuestos.

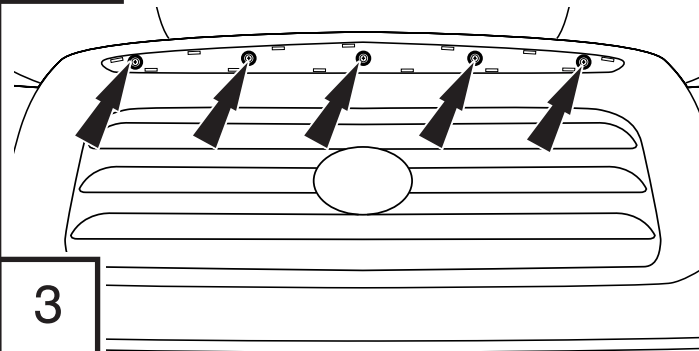

3

Levante el capó cuidadosamente.

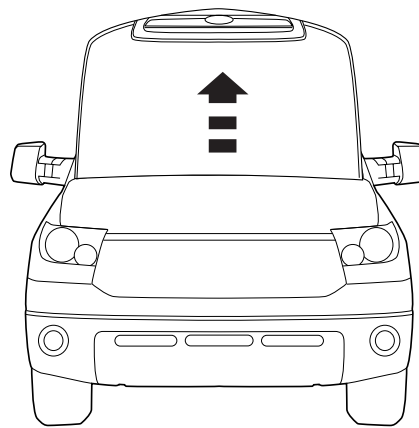

4

Extienda la mano por debajo del capó hacia la parte posterior de la parrilla y desconecte de la parrilla la varilla de enclavamiento del capó soltando el mecanismo de traba y levantando suavemente la varilla para alejarla de la parrilla.



5



Extienda la mano por debajo del capó hacia la parte posterior de la parrilla y, con una llave para tuercas, extraiga las (10) tuercas.

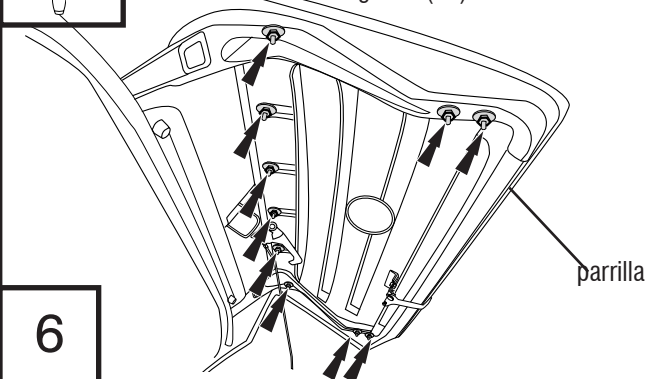

6

Baje el capó cuidadosamente.

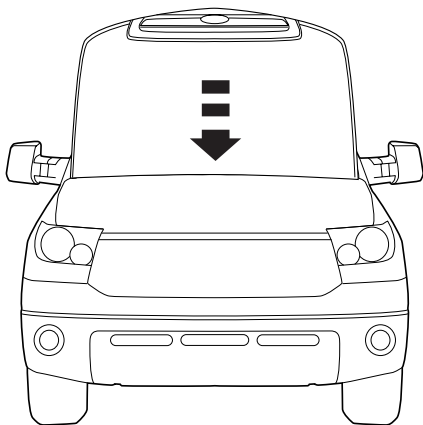

7



Enmascare el área con cinta. Comenzando por la esquina superior del lado del conductor, y luego por el lado del pasajero, utilice el escariador para apalancar cuidadosamente la parrilla y separarla del capó. Separe la parrilla.

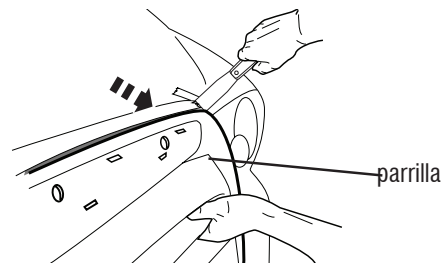
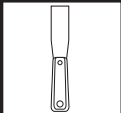

8

**NOTA:** La parrilla hará un sonido de "estallido" a medida que se separa del vehículo. Esto es normal.



Limpie el frente del borde del capó y levante el capó cuidadosamente.

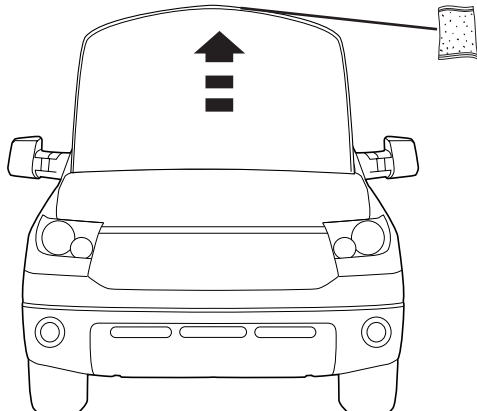

9

Pruebe el ajuste entre la cubierta del capó y el capó y ubique los orificios exteriores en la cubierta del capó y los orificios exteriores correspondientes en el capó.

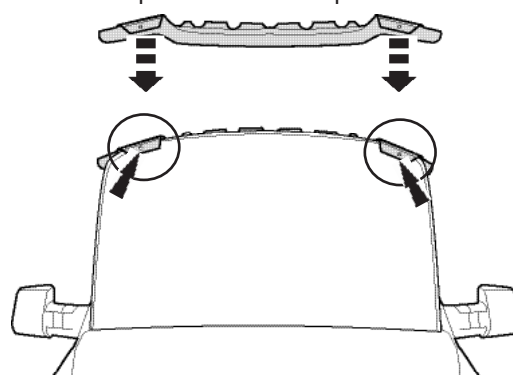

10

# Pasos de instalación

**NOTA:** La aplicación real tal vez no sea igual a las ilustraciones.



Limpie los dos (2) orificios exteriores del capó con el paño con alcohol y deje secar.

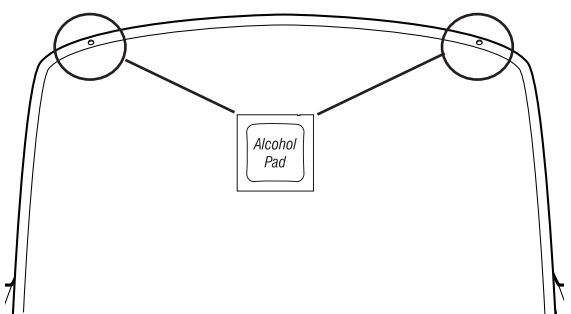

11

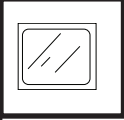

Envuelva con una película protectora el borde del capó como se muestra.

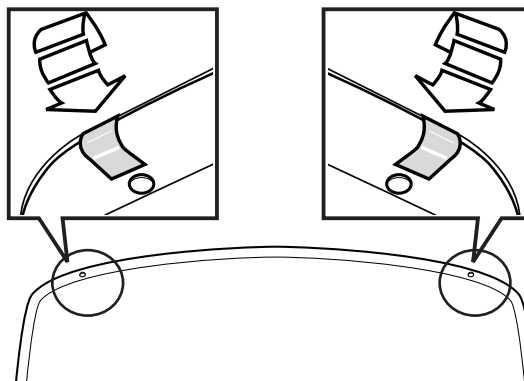

12

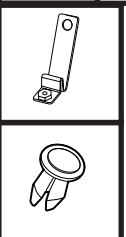

Acople dos (2) soportes al capó usando (2) sujetadores.

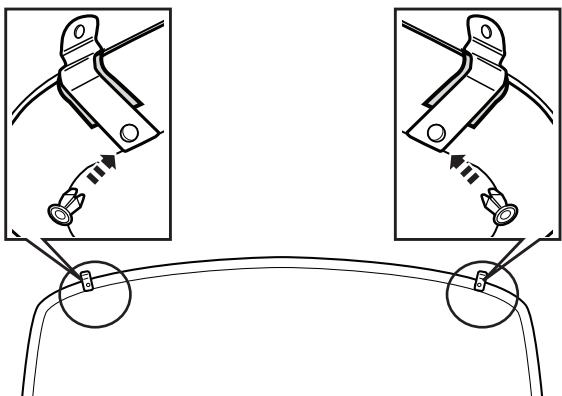

13

Baje el capó cuidadosamente.

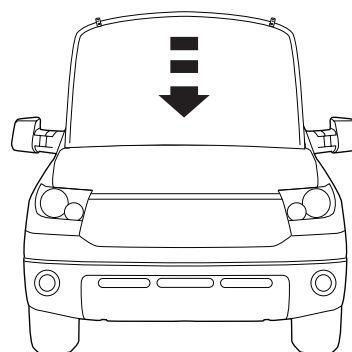

14

Alinee la cubierta del capó con el borde del capó. Asegúrese de que los orificios de la cubierta del capó se alineen con los orificios superiores del soporte.

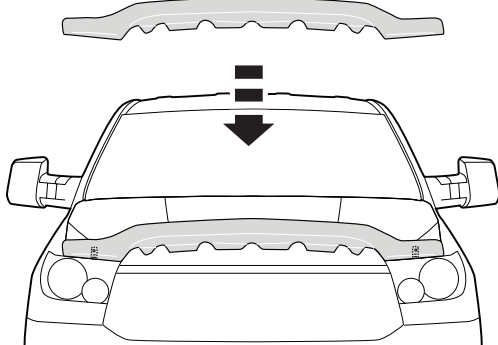

15

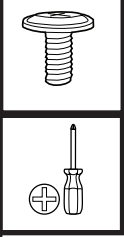

Acople la cubierta del capó a **ambos** soportes usando tornillos.

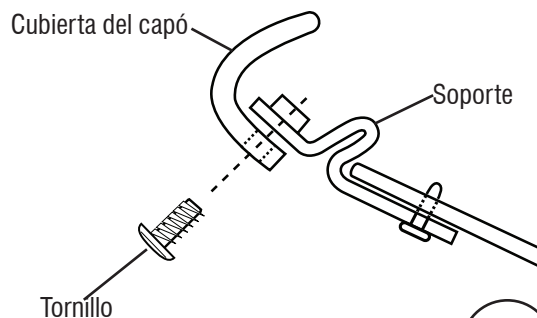

16

**NOTA:** NO ajuste demasiado.

**X2**



**NOTA: SÓLO Sequoia 2008 en adelante y Tundra 2010 en adelante**

Reemplace los (5) pasadores blancos existentes en la parte posterior de la parrilla por los pasadores más largos que se incluyen en el set.

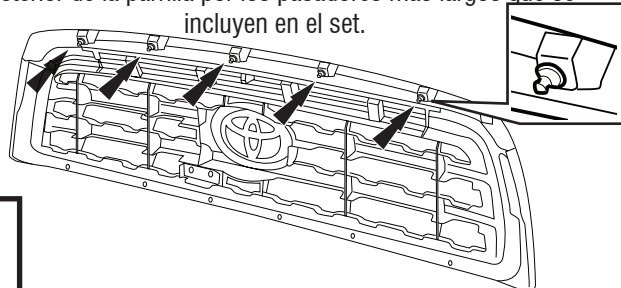

17

Vuelva a instalar la parrilla alineándola con los orificios del borde del capó. Asegúrese de que la cubierta del capó se encuentre **ENTRE** la parrilla y el capó.

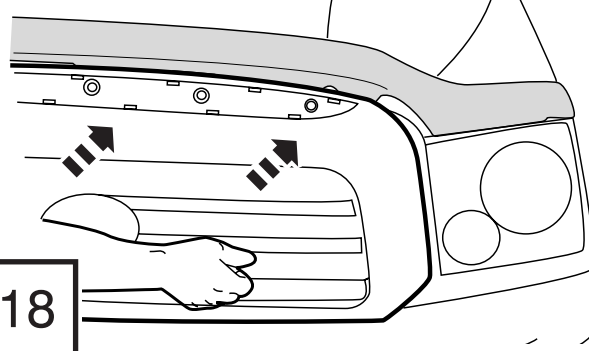

18

**Pasos de instalación** **NOTA:** La aplicación real tal vez no sea igual a las ilustraciones.

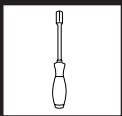

**NOTA: SÓLO Tundra 2007-2009**

Para volver a acoplar la parrilla, reinstale los (5) tornillos extraídos anteriormente.

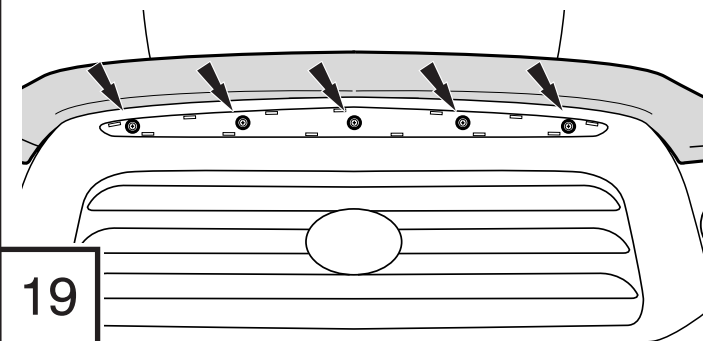

Levante el capó cuidadosamente.

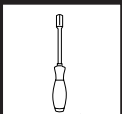
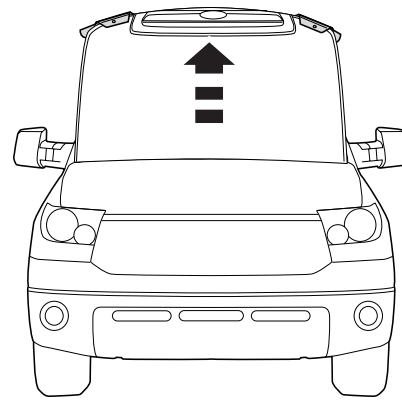

Extienda la mano por debajo del capó hacia la parte posterior de la parrilla y vuelva a instalar las (10) tuercas extraídas anteriormente.

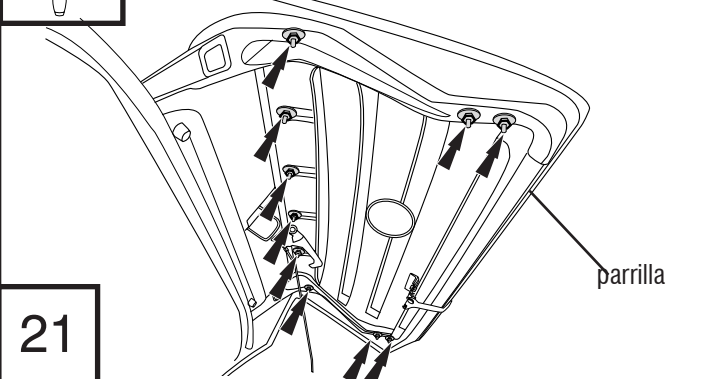

Extienda la mano por debajo del capó hacia la parte posterior de la parrilla y vuelva a acoplar la varilla de enclavamiento del capó a la parrilla.

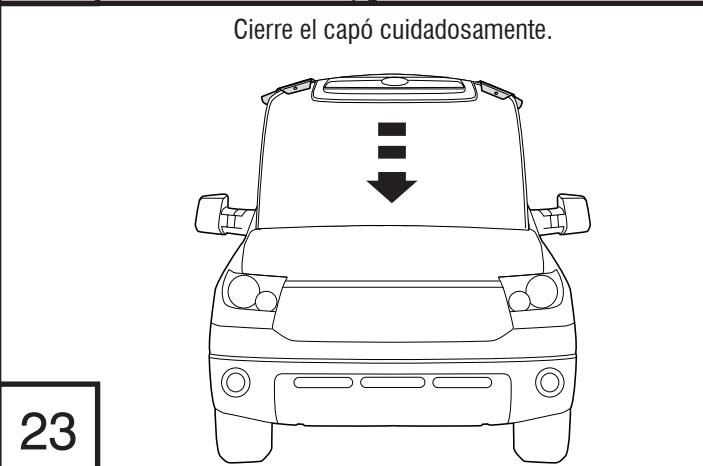
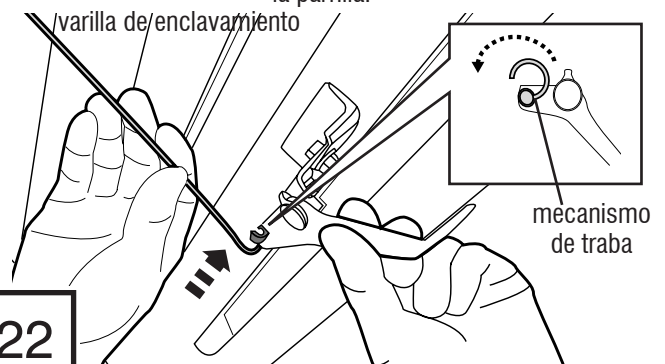

Cierre el capó cuidadosamente.

**NOTA: SÓLO Tundra 2007-2009**

Cuidadosamente, vuelva a instalar el aplique extraído anteriormente. Deslice las bridas superiores primero y luego presione firmemente para cerrar las pestañas restantes en su lugar.

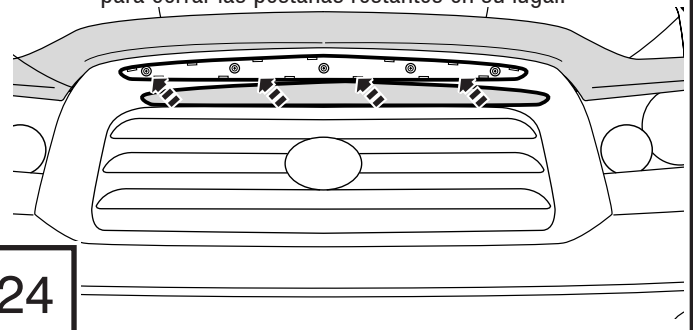

**Cuidado y Limpieza**

- Lave sólo con jabón suave y seque con un paño limpio.

**¡Felicitaciones!**

Usted ha adquirido uno de los tantos productos de calidad de marca Lund® que ofrece Lund International, Inc. Nos enorgullecen mucho nuestros productos y deseamos que disfrute años de satisfacción por su inversión. Nos hemos esforzado mucho para asegurarnos de que su producto sea de gran calidad en cuanto a ajuste, durabilidad, acabado y facilidad de instalación.



Lund International, Lund Accessories Division  
4325 Hamilton Mill Rd. Suite 400, Buford, GA 30518  
800-328-5863 • Visitenos en [lundinternational.com](http://lundinternational.com)



© 2011 Lund International, Inc. Todos los derechos reservados.  
Lund® y el logo de Lund® son marcas registradas de Lund International, Inc.

