



## Interceptor™

**For proper installation and best possible fit, please read all instructions BEFORE you begin.  
For technical assistance or to obtain missing parts, please call Customer Relations at 1-800-241-7219.**

### Important Safety Information



- CAUTION - Before driving, ensure that the hood shield is properly secured to vehicle.
- Do not use automatic "brush-style" car washes.
- Do not use cleaning solvents of any kind.
- Periodically check all components for tightness.

### Contents

**NOTE:** Actual product may vary from illustration.



Hood shield



Screw x4



Plastic Washer x4



Protective Film x2

### Tools Required



Car Wash Supplies



Clean Towel



Phillips screwdriver

### Preparation Before Painting / Installation

- A trial fit is recommended to ensure proper positioning and fit.
- Check fit of parts before painting as we will not accept the return of modified or painted parts.
- Wash and dry your vehicle to remove any debris and/or dirt from the installation area.

### Installation Steps

**NOTE:** Actual application may vary slightly from illustrations.

Open hood. Remove the rubber trim piece from the leading edge of hood. Discard rubber trim.

Rubber Trim

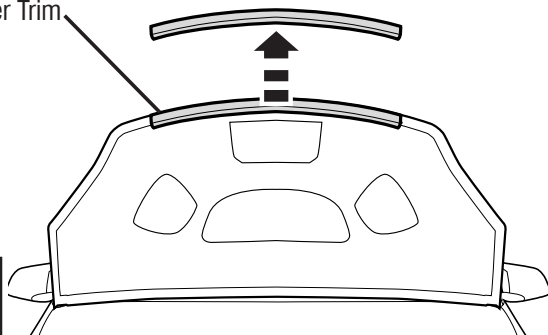

1

Align hood shield holes with holes in hood.

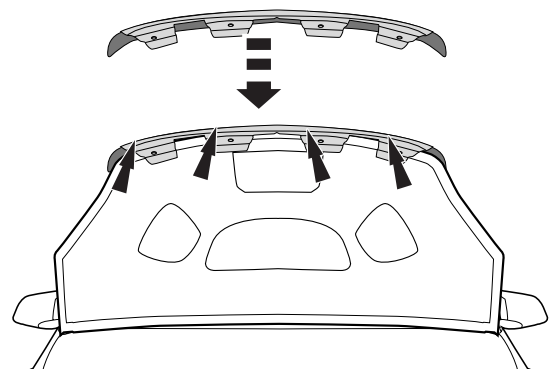

2

## Installation Steps

**NOTE:** Actual application may vary slightly from illustrations.

Insert (1) screw with washer and screw until snug. Repeat for remaining (3) fasteners.

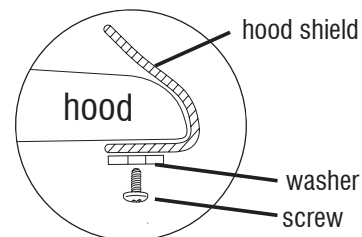
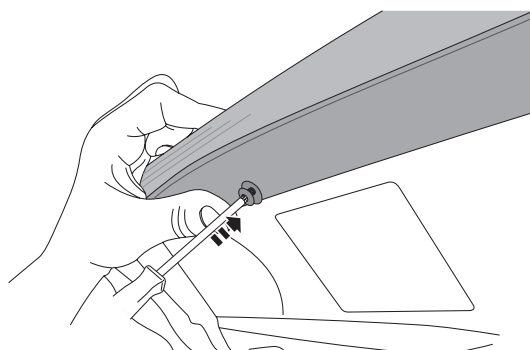

3

**DO NOT OVER TIGHTEN**

Apply a strip of protective film on each of the two (2) **TOP** corners of the grille.

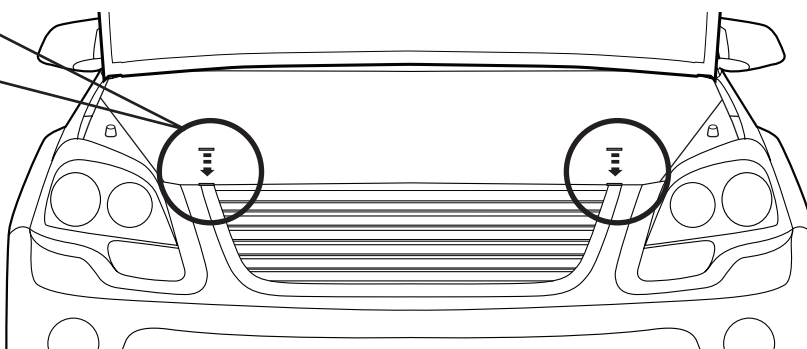
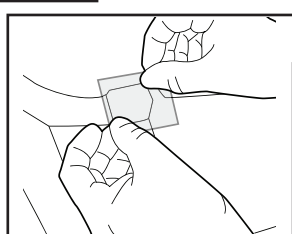

4

Turn out (counter clockwise) both fender bump stops as needed to clear grille.

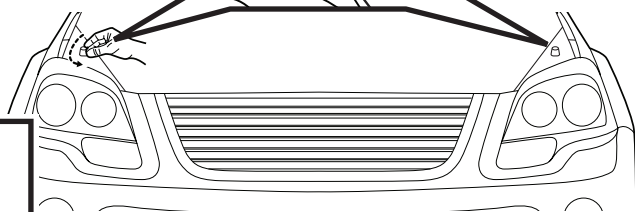
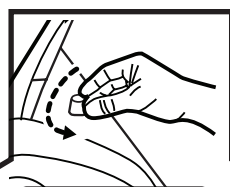

5

Close hood.

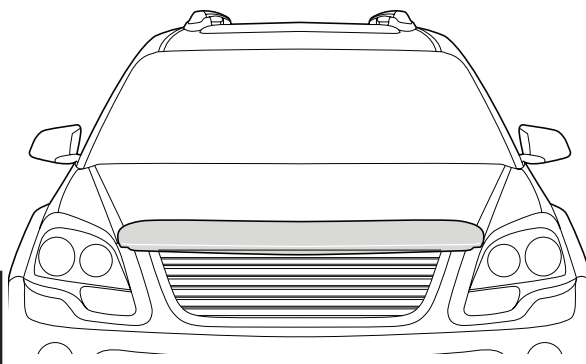

6

## Care and Cleaning

- Wash only with mild soap & dry with a clean cloth.

## Congratulations!

You have purchased one of the many quality Lund® branded products offered by Lund International, Inc. We take the utmost pride in our products and want you to enjoy years of satisfaction from your investment. We have made every effort to ensure that your product is top quality in terms of fit, durability, finish and ease of installation.

# LUND®

Lund International

800-241-7219 • Visit us at [lundinternational.com](http://lundinternational.com)

© 2012 Lund International, Inc. All rights reserved.

Lund® and the Lund® logo are trademarks of Lund International, Inc.



# LUND®

## Interceptor™

Pour obtenir une installation correcte et le meilleur ajustement possible, lire toutes les instructions AVANT de commencer. Pour toute assistance technique ou obtention de pièces manquantes, appeler le service des relations avec la clientèle au 1-800-241-7219.

### Informations importantes concernant la sécurité



- ATTENTION – Avant de conduire, s'assurer que le pare-insectes est solidement assujettie sur le véhicule.
- Ne pas utiliser les stations de lavage de voitures à brosse.
- Ne pas utiliser de solvants.
- Vérifier régulièrement le serrage des composants.

### Contenu **NOTE:** Le produit réel peut changer de l'illustration.



Protection de capot



4 fixations



4 rondelles en plastique



2 films protecteurs

### Outils nécessaires



Équipement de nettoyage



Linge propre

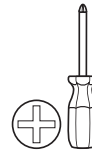

Tournevis Phillips

### Préparation pour la peinture/l'installation

- Il est recommandé de procéder à un essai pour s'assurer que le positionnement et l'ajustement sont corrects.
- Vérifier l'ajustement des pièces avant peinture, car nous n'acceptons pas le retour de pièces modifiées ou peintes.
- Laver les glissières de glaces de la portière du véhicule pour éliminer toute poussière et tous débris.
- Sécher les glissières avec une serviette propre.

### Étapes d'installation

**REMARQUE :** La méthode d'application peut être légèrement différente de celle représentée par les illustrations.

Ouvrez le capot. Déposez la garniture en caoutchouc du bord d'attaque du capot. Mettez au rebut la garniture en caoutchouc.

Garniture en caoutchouc

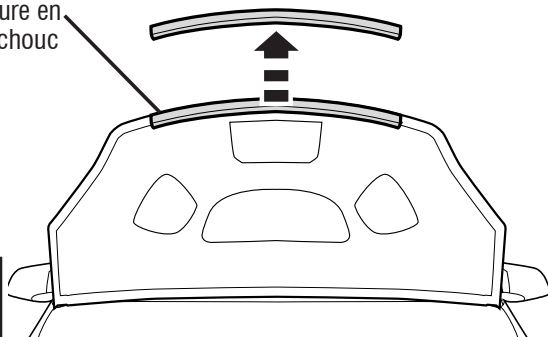

1

Alignez les trous du protège-capot avec les trous du capot.

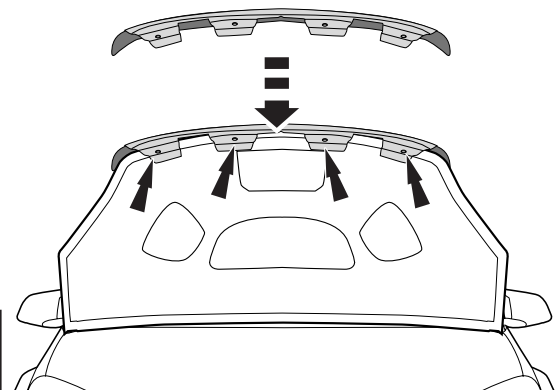

2

## Étapes d'installation

REMARQUE : La méthode d'application peut être légèrement différente de celle représentée par les illustrations.



3

Insérez la fixation (1) avec la rondelle et vissez à fond. Procédez de même avec les (3) autres fixations.

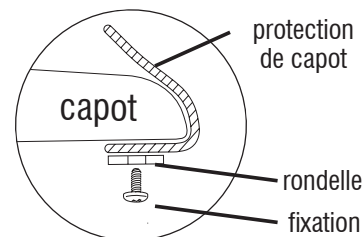
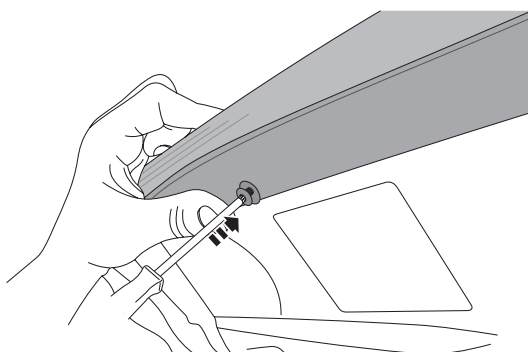

**NE PAS SERRER À L'EXCÈS**



Appliquez une bande de film protecteur sur les deux (2) coins **SUPÉRIEURS** de la grille.

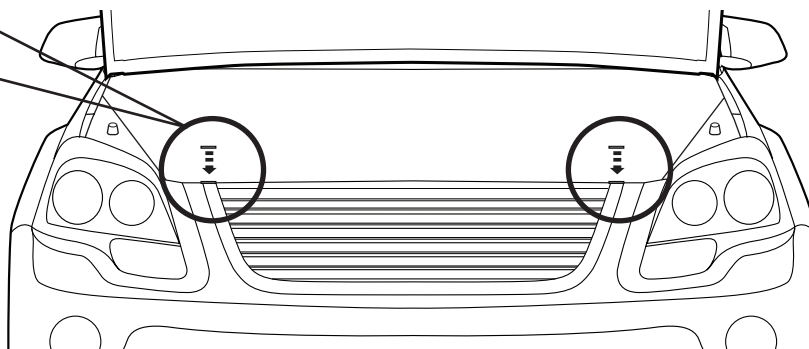
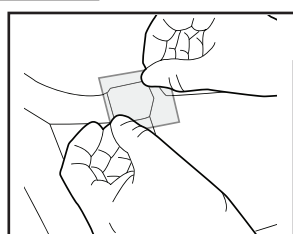

4

Démouler (sens anti-horaire), les deux ailes bosse s'arrête que nécessaire pour vider le grille.

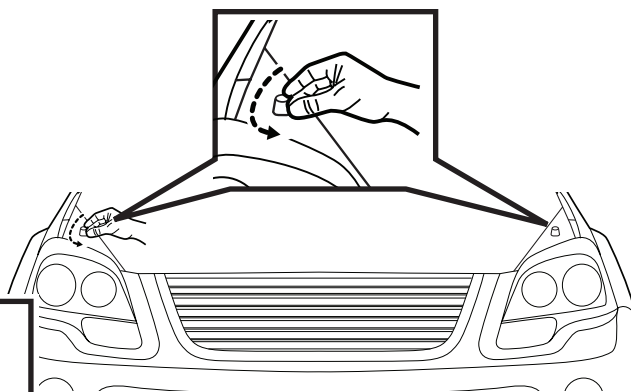

5

Fermez le capot.

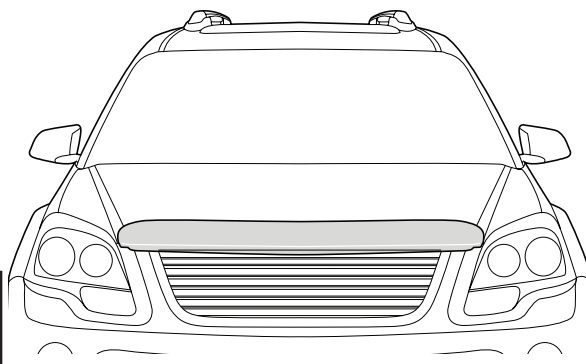

6

## Entretien et nettoyage

- Laver exclusivement avec de l'eau savonneuse et sécher avec un chiffon propre.

## Félicitations !

Vous venez d'acheter un des nombreux produits de qualité de la marque Lund<sup>®</sup> fabriqués par Lund International, Inc. Nous sommes extrêmement fiers de la qualité de nos produits et nous espérons que vous profiterez de cet investissement de longues années durant. Nous nous efforçons d'offrir la meilleure qualité en termes d'ajustement, de finition, de durabilité et de facilité d'installation.

# LUND<sup>®</sup>

Lund International

800-241-7219 • Visitez notre site [lundinternational.com](http://lundinternational.com)

© 2012 Lund International, Inc. Tous droits réservés.

Lund<sup>®</sup> et le logo Lund<sup>®</sup> sont des marques déposées de Lund International, Inc.



# LUND®

## Interceptor™

**Para una instalación adecuada y el mejor ajuste posible, lea todas las instrucciones ANTES de comenzar. Si desea recibir asistencia técnica u obtener piezas faltantes, llame al Servicio al cliente al 1-800-241-7219.**

### Información importante de seguridad



- **PRECAUCIÓN** - Antes de conducir, asegúrese de que la visera deflectora esté correctamente anclada al vehículo.
- No utilice servicios automáticos de limpieza de vehículos que utilizan cepillos.
- No utilice limpiadores al solvente de ningún tipo.
- Compruebe periódicamente que todos los componentes estén ajustados.

### Contenido

**NOTA:** El producto real puede variar de la ilustración.



Cubierta del capó



Sujetador x4



Arandela de plástico x4



Película protectora x2

### Herramientas necesarias



Equipo de limpieza de vehículos



Toalla limpia



Destornillador Phillips

### Preparación antes de pintar o instalar

- Se recomienda realizar un ajuste de prueba para asegurar el posicionamiento y ajuste correctos.
- Compruebe que las piezas se ajusten correctamente antes de pintarlas, ya que no aceptaremos la devolución de piezas modificadas o pintadas.
- Lave los canales de la ventanilla del vehículo para quitar los desechos y la suciedad.
- Seque los canales de la ventanilla con una toalla limpia.

### Pasos de instalación

**NOTA:** El uso real puede variar levemente de ilustraciones.

Abra el capó. Quite la banda de caucho del borde anterior del capó. Deseche la banda de caucho.

Banda de caucho

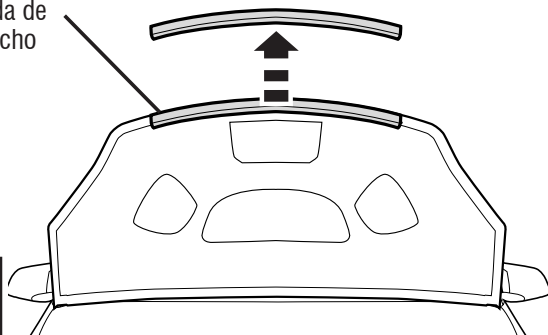

1

Alinee los orificios de la cubierta del capó con los orificios del capó.

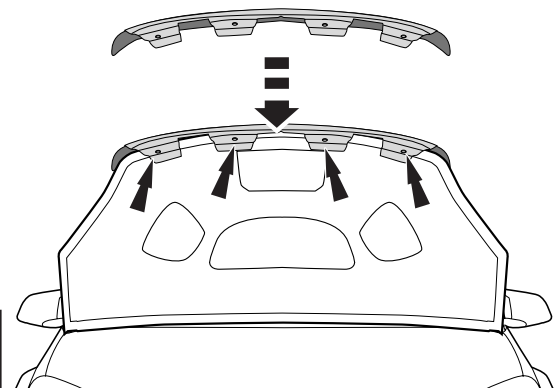

2

## Pasos de instalación

**NOTA:** El uso real puede variar levemente de ilustraciones.



Introduzca (1) sujetador con la arandela y enrosque hasta que quede ajustado. Repita la operación con los sujetadores (3) restantes.

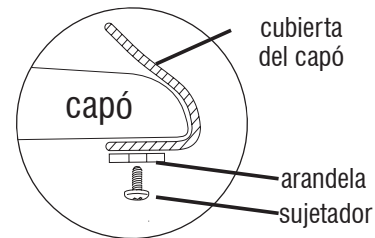
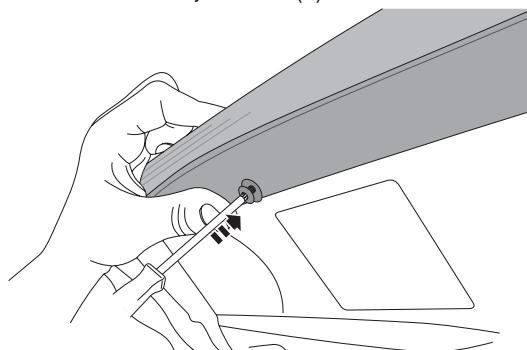

3

**NO AJUSTE DEMASIADO.**



Aplique una cinta de película protectora en cada uno de las dos (2) esquinas **SUPERIORES** de la parrilla.

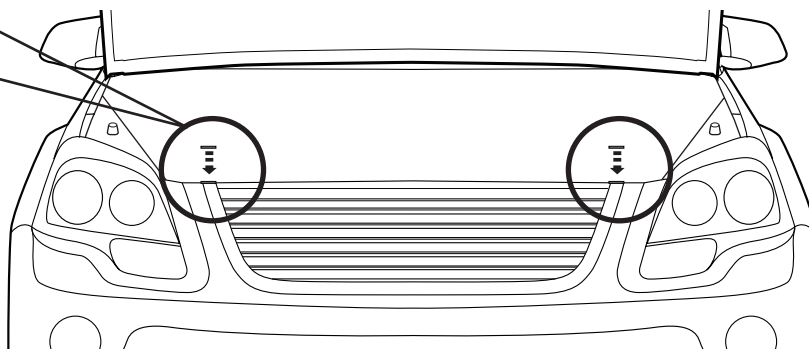
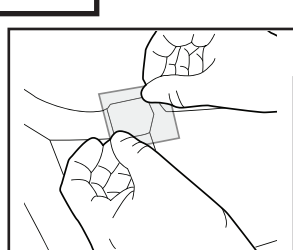

4

Apaga (izquierda), ambos guardabarros golpe se detiene como sea necesario para la parrilla.

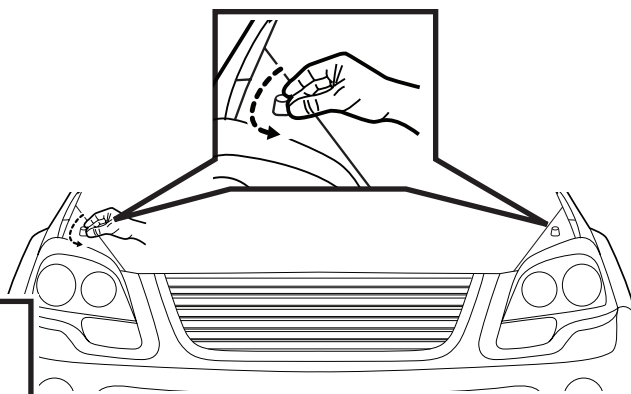

5

Cierre el capó.

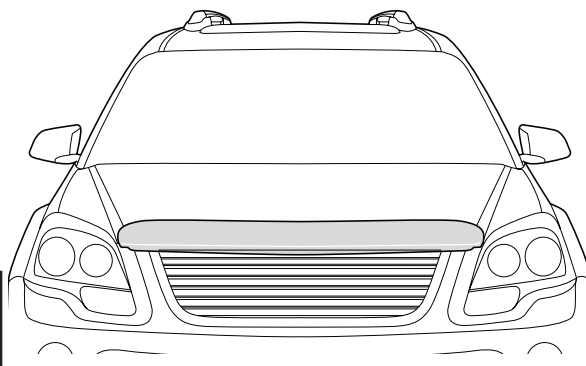

6

## Cuidado y limpieza

- Limpie solamente con agua jabonosa tibia y seque con un paño limpio.

## Felicidades

Usted ha adquirido uno de los tantos productos de calidad de marca Lund<sup>®</sup> que ofrece Lund International, Inc. Nos enorgullecen mucho nuestros productos y deseamos que disfrute años de satisfacción por su inversión. Nos hemos esforzado mucho para asegurarnos de que su producto sea de gran calidad en cuanto a ajuste, durabilidad, acabado y facilidad de instalación.

# LUND<sup>®</sup>

Lund International

800-241-7219 • Visite nuestro sitio Web: [lundinternational.com](http://lundinternational.com)

© 2012 Lund International, Inc. Todos los derechos reservados.

Lund<sup>®</sup> y el logo de Lund<sup>®</sup> son marcas registradas de Lund International, Inc.

