



Interceptor™

**For proper installation and best possible fit, please read all instructions BEFORE you begin.
For technical assistance or to obtain missing parts, please call Customer Relations at 1-800-241-7219.**

Important Safety Information



- CAUTION - Before driving, ensure that the hood shield is properly secured to vehicle.
- Do not use automatic "brush-style" car washes.
- Do not use cleaning solvents of any kind.
- Periodically check all components for tightness.

Contents

NOTE: Actual product may vary from illustration.



Hood shield

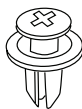

Fastener x2
(98028 & 98029)



Protective Film x1
(45-3601)



Self Tapping Screw x1
(98023)



White Plastic
Washer x1
(98022)

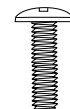

Machine Screw x1
(04-4128)



Black Plastic
Washer x1
(37-4106)



Bracket x1
(39-1956)

Tools Required



Car Wash Supplies

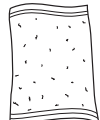

Clean Towel



Phillips
screwdriver



Grease pencil

Preparation Before Painting / Installation

- A trial fit is recommended to ensure proper positioning and fit.
- Check fit of parts before painting as we will not accept the return of modified or painted parts.
- Wash and dry your vehicle to remove any debris and/or dirt from the installation area.

Installation Steps

NOTE: Actual application may vary slightly from illustrations.

Open hood.

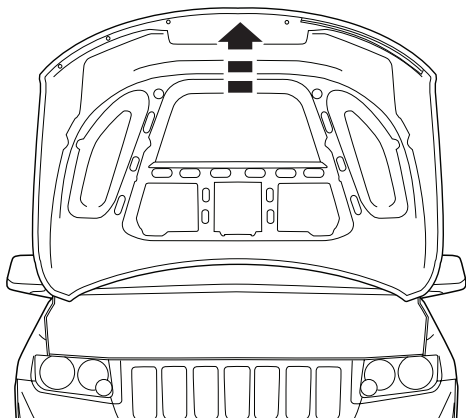

1



Install bracket on hood shield flange using machine screw and black washer.



2

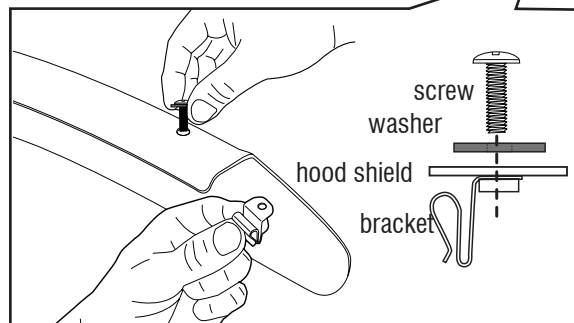

Installation Steps

NOTE: Actual application may vary slightly from illustrations.

Align holes in hood shield with holes in hood in order to center part in place. Note the location where the bracket will align with hood edge and mark with a grease pencil. Remove hood shield.

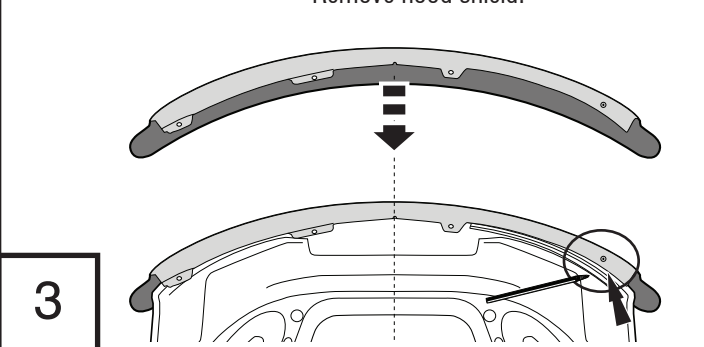

Center protective film over grease pencil mark, and wrap around the hood edge.

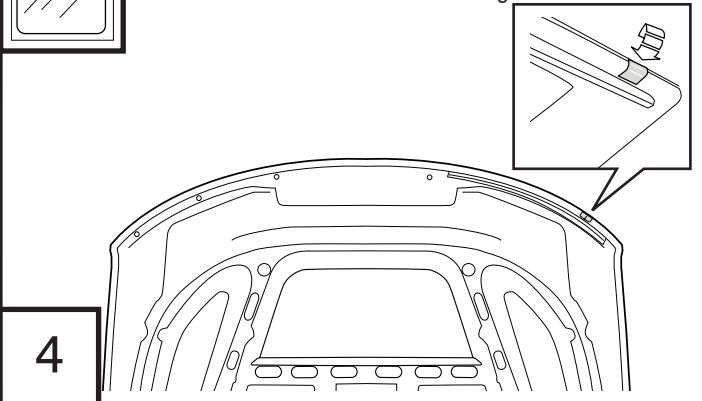

Position hood shield back in place on hood. Ensure that the holes in hood shield are properly aligned with the holes in the hood and that the bracket aligns with the protective film.

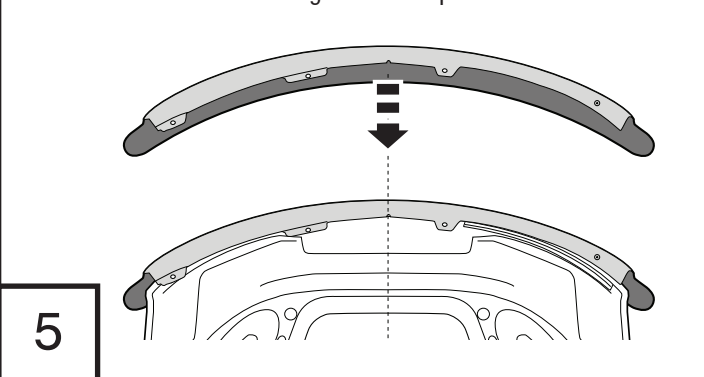

Insert (1) fastener through the hood shield and into the hood and securely tighten. Repeat for remaining fastener.

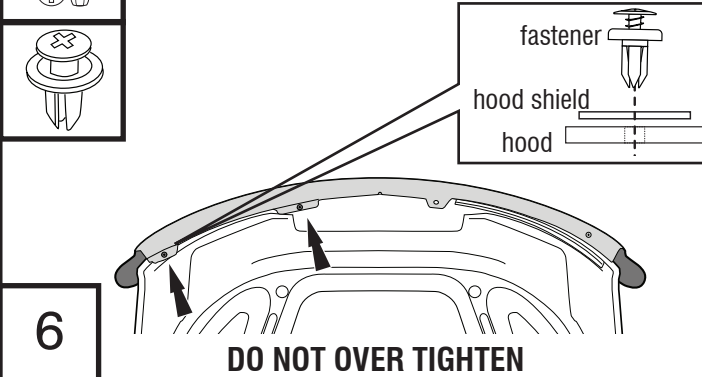

Insert self tapping screw with washer through the hood shield and into the hood. Securely tighten.

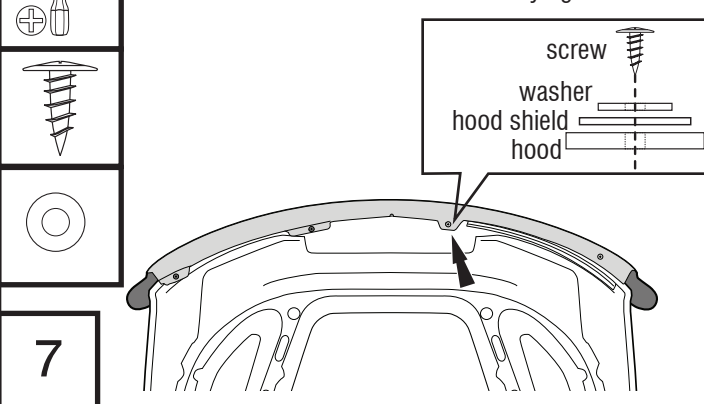

Slide bracket over hood edge, ensuring that it is centered on the protective film previously installed in Step 4. Carefully close hood.

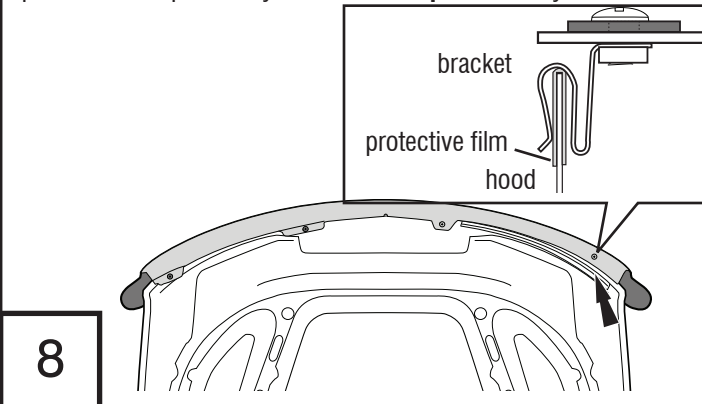

Care and Cleaning

- Wash only with mild soap & dry with a clean cloth.

Congratulations!

You have purchased one of the many quality Lund® branded products offered by Lund International, Inc. We take the utmost pride in our products and want you to enjoy years of satisfaction from your investment. We have made every effort to ensure that your product is top quality in terms of fit, durability, finish and ease of installation.

LUND®

Lund International

800-241-7219 • Visit us at lundinternational.com

© 2012 Lund International, Inc. All rights reserved.

Lund® and the Lund® logo are trademarks of Lund International, Inc.



LUND®

Interceptor™

Pour obtenir une installation correcte et le meilleur ajustement possible, lire toutes les instructions AVANT de commencer. Pour toute assistance technique ou obtention de pièces manquantes, appeler le service des relations avec la clientèle au 1-800-241-7219.

Informations importantes concernant la sécurité



- ATTENTION – Avant de conduire, s'assurer que le pare-insectes est solidement assujettie sur le véhicule.
- Ne pas utiliser les stations de lavage de voitures à brosse.
- Ne pas utiliser de solvants.
- Vérifier régulièrement le serrage des composants.

Contenu **NOTE:** Le produit réel peut changer de l'illustration.



Protection de capot

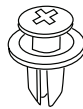

2 fixations
(98028 & 98029)



1 vis autotaraudeuse
(98023)

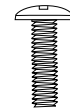

1 vis à métaux
(04-4128)



1 support
(39-1956)



1 film protecteur
(45-3601)



1 rondelle
en plastique blanche
(98022)



1 rondelle
noire
(37-4106)

Outils nécessaires



équipement de nettoyage

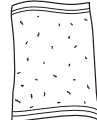

Chiffon propre



Tournevis
Phillips



Crayon gras

Préparation pour la peinture/l'installation

- Il est recommandé de procéder à un essai pour s'assurer que le positionnement et l'ajustement sont corrects.
- Vérifier l'ajustement des pièces avant peinture, car nous n'acceptons pas le retour de pièces modifiées ou peintes.
- Laver les glissières de glaces de la portière du véhicule pour éliminer toute poussière et tous débris.
- Sécher les glissières avec une serviette propre.

Étapes d'installation

REMARQUE : La méthode d'application peut être légèrement différente de celle représentée par les illustrations.

Ouvrez le capot.

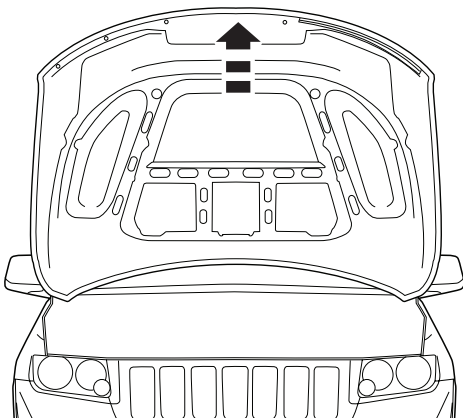

1



Installez le support sur la bride de protection de capot à l'aide de vis à métaux et de la rondelle noire.



2

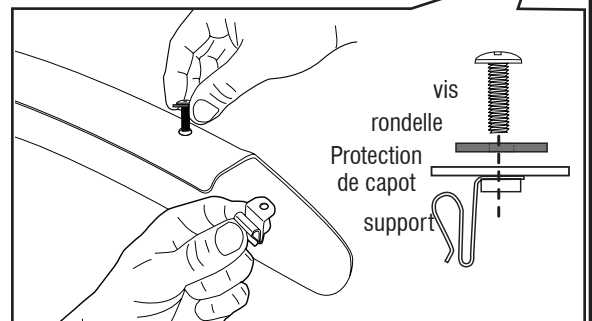

vis
rondelle
Protection de capot
support

Étapes d'installation

REMARQUE : La méthode d'application peut être légèrement différente de celle représentée par les illustrations.



Alignez les trous dans la protection de capot avec les trous du capot de façon à centrer la pièce à la bonne place. Repérez l'endroit où le support s'alignera avec le bord du capot et marquez-le avec un crayon gras. Retirez la protection de capot.

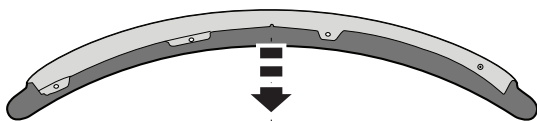

3

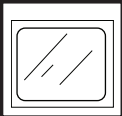
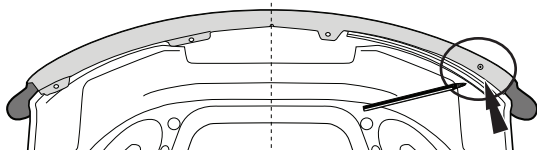

Centrez le film protecteur sur le marquage au crayon gras et emballez autour du bord du capot.

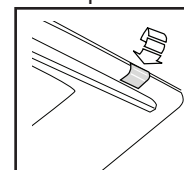

4

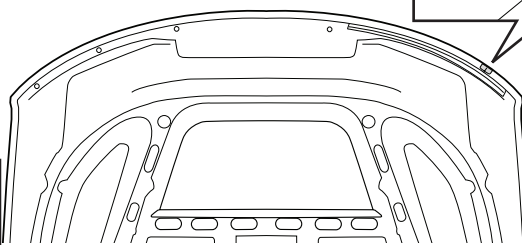

Remettez la protection de capot en place sur le capot. Assurez-vous que les trous sur la protection de capot soient correctement alignés avec les trous du capot et que le support s'aligne correctement avec le film protecteur.

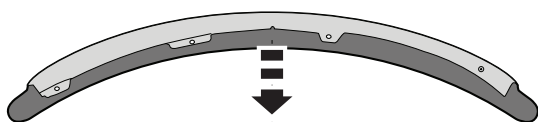

5

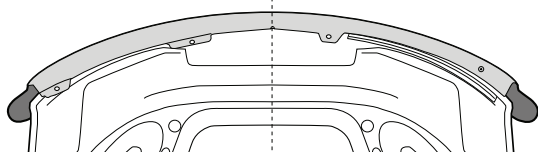

Insérez (1) fixation à travers la protection de capot, dans le capot, puis serrez fermement. Procédez de même avec les autres fixations.

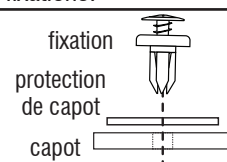
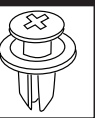

6

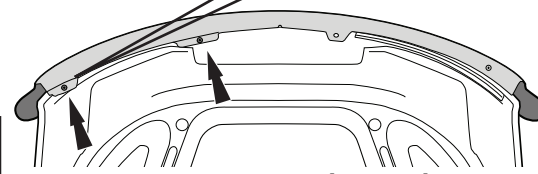

NE PAS SERRER À L'EXCÈS



Insérez la vis autotaraudeuse avec rondelle à travers la protection de capot, dans le capot. Serrez fixement.

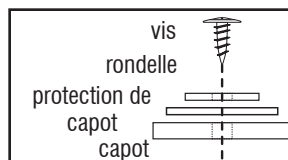

7

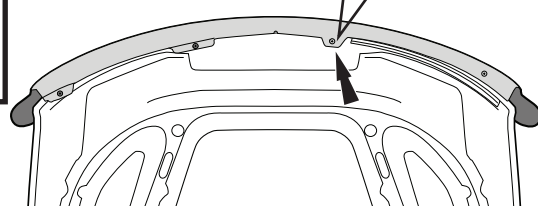

Faites glisser le support au-dessus du bord du capot, en vous assurant qu'il soit centré sur le film protecteur installé précédemment à l'Étape 4. Refermez doucement le capot.

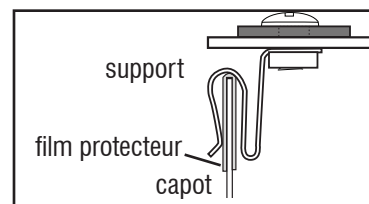

8

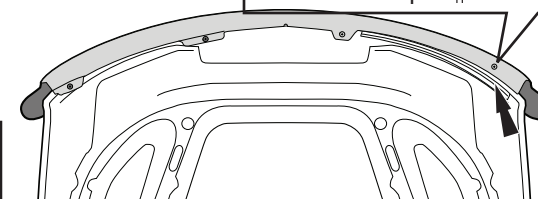

Entretien et nettoyage

- Laver exclusivement avec de l'eau savonneuse et sécher avec un chiffon propre.

Félicitations !

Vous venez d'acheter un des nombreux produits de qualité de la marque Lund[®] fabriqués par Lund International, Inc. Nous sommes extrêmement fiers de la qualité de nos produits et nous espérons que vous profiterez de cet investissement de longues années durant. Nous nous efforçons d'offrir la meilleure qualité en termes d'ajustement, de finition, de durabilité et de facilité d'installation.

LUND[®]

Lund International

800-241-7219 • Visitez notre site lundinternational.com

© 2012 Lund International, Inc. Tous droits réservés.

Lund[®] et le logo Lund[®] sont des marques déposées de Lund International, Inc.



LUND

Interceptor™

Para una instalación adecuada y el mejor ajuste posible, lea todas las instrucciones ANTES de comenzar. Si desea recibir asistencia técnica u obtener piezas faltantes, llame al Servicio al cliente al 1-800-241-7219.

Información importante de seguridad



- PRECAUCIÓN - Antes de conducir, asegúrese de que la visera deflectora esté correctamente anclada al vehículo.
- No utilice servicios automáticos de limpieza de vehículos que utilizan cepillos.
- No utilice limpiadores al solvente de ningún tipo.
- Compruebe periódicamente que todos los componentes estén ajustados.

Contenido

NOTA: El producto real puede variar de la ilustración.



Cubierta para capó

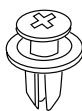

Sujetador x2
(98028 & 98029)



Tornillo autorroscante x1
(98023)

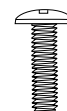

Tornillo para metales x1
(04-4128)



Soporte x1
(39-1956)



Película protectora x1
(45-3601)



Arandela blanca de plástico x1
(98022)



Arandela negra x1
(37-4106)

Herramientas necesarias



Equipo de limpieza de vehículos

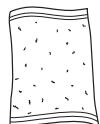

Toalla limpia



Destornillador Phillips



Lápiz de cera

Preparación antes de pintar o instalar

- Se recomienda realizar un ajuste de prueba para asegurar el posicionamiento y ajuste correctos.
- Compruebe que las piezas se ajusten correctamente antes de pintarlas, ya que no aceptaremos la devolución de piezas modificadas o pintadas.
- Lave los canales de la ventanilla del vehículo para quitar los desechos y la suciedad.
- Seque los canales de la ventanilla con una toalla limpia.

Pasos de instalación

NOTA: El uso real puede variar levemente de ilustraciones.

Abra el capó.

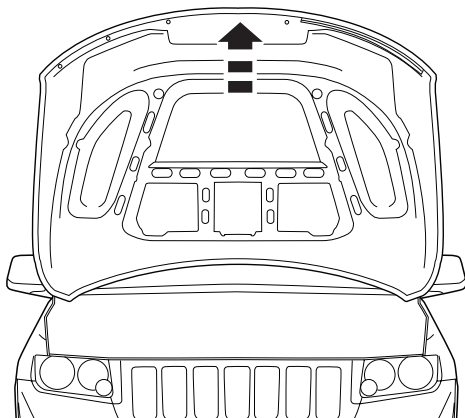

1



Instale el soporte en el reborde de la cubierta del capó utilizando un tornillo para metales y una arandela negra.



2

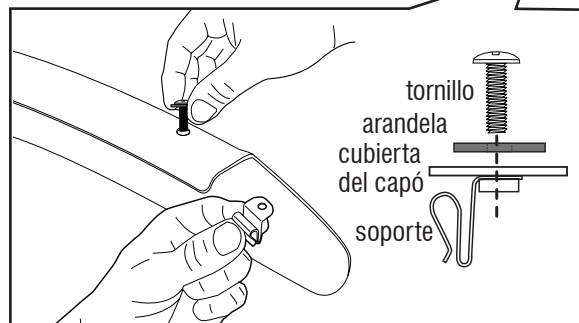

tornillo
arandela
cubierta del capó
soporte

Pasos de instalación

NOTA: El uso real puede variar levemente de ilustraciones.



Alinee los orificios de la cubierta del capó con los orificios del capó para centrar la pieza en su lugar. Observe el lugar donde el soporte se alineará con el borde del capó y marque con un lápiz de cera. Quite la cubierta del capó.

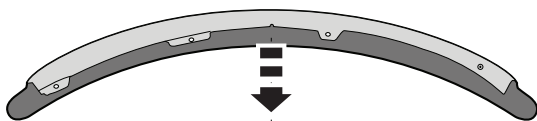

3

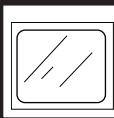
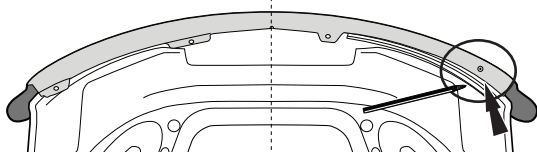

Centre la película protectora encima de la marca que hizo con el lápiz de cera y envuelva con ella el borde del capó.

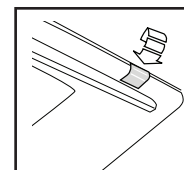

4

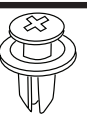
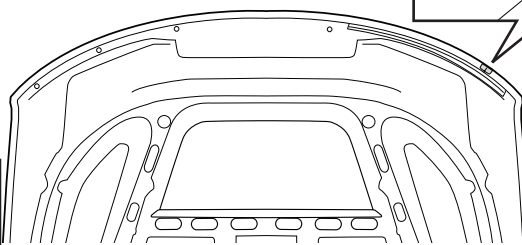

Introduzca un (1) sujetador a través de la cubierta del capó y hacia adentro de éste, y ajuste bien. Repita la operación con los sujetadores restantes.

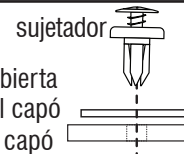

5

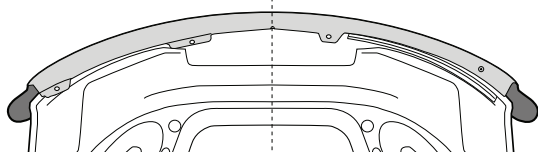
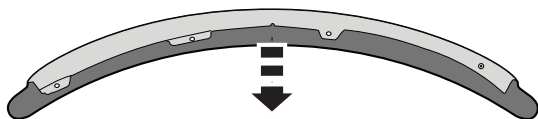

6

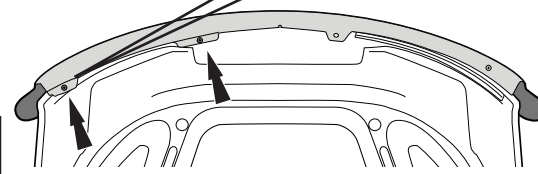

NO AJUSTE DEMASIADO



Introduzca el tornillo autorroscante con arandela a través de la cubierta del capó y hacia adentro de éste. Ajuste bien.

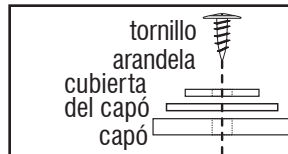

7

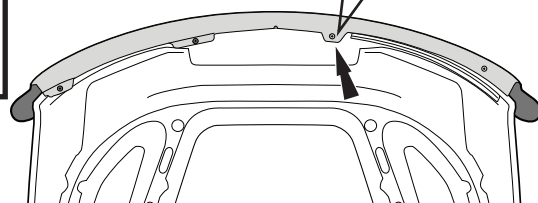

Deslice el soporte por el borde del capó y asegúrese de que esté centrado sobre la película protectora previamente colocada en el Paso 4. Cierre con cuidado la capucha.

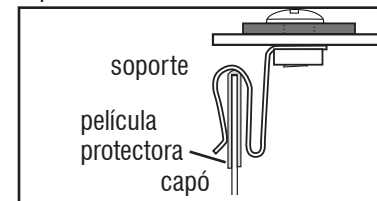

8

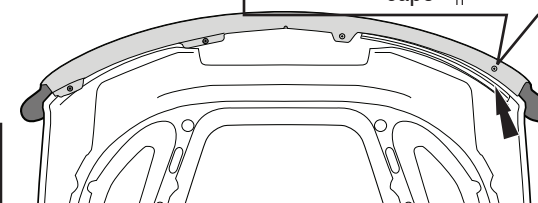

Cuidado y limpieza

- Limpie solamente con agua jabonosa tibia y seque con un paño limpio.

Felicidades

Usted ha adquirido uno de los tantos productos de calidad de marca Lund[®] que ofrece Lund International, Inc. Nos enorgullecen mucho nuestros productos y deseamos que disfrute años de satisfacción por su inversión. Nos hemos esforzado mucho para asegurarnos de que su producto sea de gran calidad en cuanto a ajuste, durabilidad, acabado y facilidad de instalación.

LUND[®]

Lund International

800-241-7219 • Visite nuestro sitio Web: lundinternational.com

© 2012 Lund International, Inc. Todos los derechos reservados.

Lund[®] y el logo de Lund[®] son marcas registradas de Lund International, Inc.

