

# Installation Instructions

I - Sheet Number LUNDBF120 Rev.A

# LUND®

## Interceptor™

**For proper installation and best possible fit, please read all instructions BEFORE you begin.  
For technical assistance or to obtain missing parts, please call Customer Relations at 1-800-241-7219.**

### Important Safety Information



- CAUTION - Before driving, ensure that the hood shield is properly secured to vehicle.
- Do not use automatic "brush-style" car washes.
- Do not use cleaning solvents of any kind.
- Periodically check all components for tightness.

### Contents

**NOTE:** Actual product may vary from illustration.



Hood shield

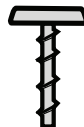

Screw  
x 4



Receptacle  
x 4



Bump On  
x4

### Tools Required



Car Wash Supplies



Clean Towel

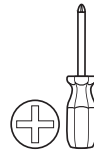

Phillips  
screwdriver



Grease Pencil

### Preparation Before Painting / Installation

- A trial fit is recommended to ensure proper positioning and fit.
- Check fit of parts before painting as we will not accept the return of modified or painted parts.
- Wash and dry your vehicle to remove any debris and/or dirt from the installation area.

### Installation Steps

**NOTE:** Actual application may vary slightly from illustrations.



Raise hood and clean the leading edge thoroughly, and allow to dry.

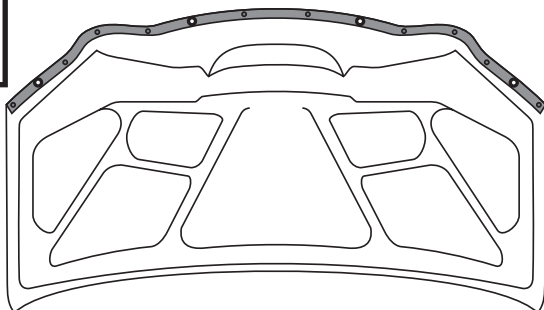

1



Test fit hood shield by centering it on the hood edge. Note where the mounting holes in the hood shield flange will be and mark with a grease pencil.

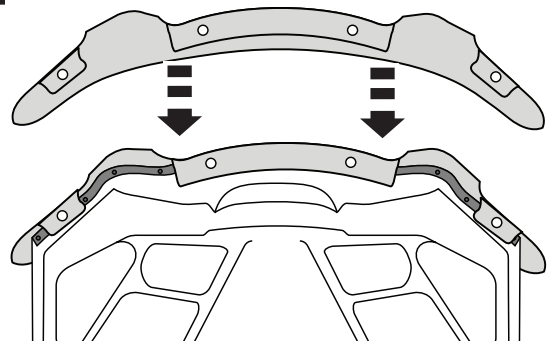

2

## Installation Steps **NOTE:** Actual application may vary slightly from illustrations.

Remove the corresponding fasteners from the rubber trim piece. This is necessary in order for the hood shield flanges to slide **under** the rubber trim piece. **NOTE:** It may be necessary to remove additional fasteners in order to accommodate the flange, depending on size.

3

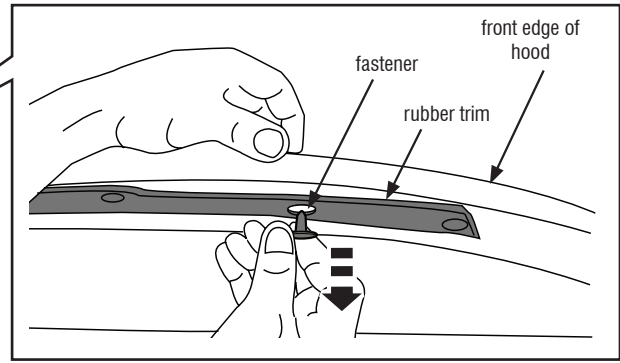
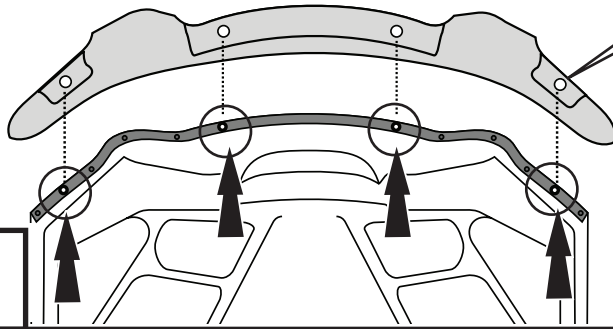

Position the hood shield with the flanges sliding **between** the hood and rubber seal. Align holes.

4

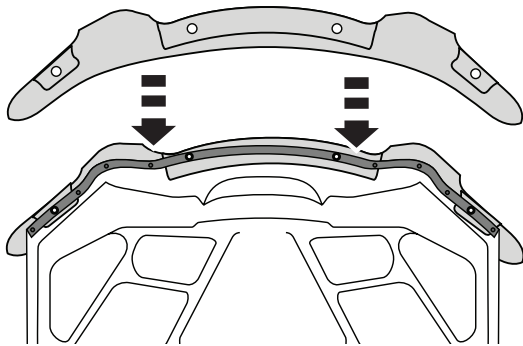

Insert (4) receptacles **UNDER** rubber trim and through hood shield, and then into hood.

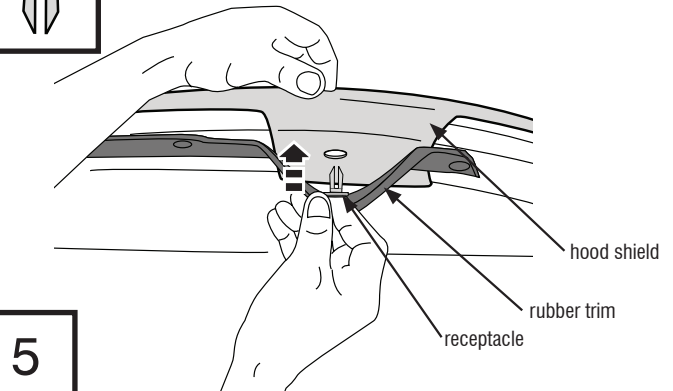

5



Insert (4) screws through rubber trim and into receptacles and apply pressure while tightening screw to secure to hood.

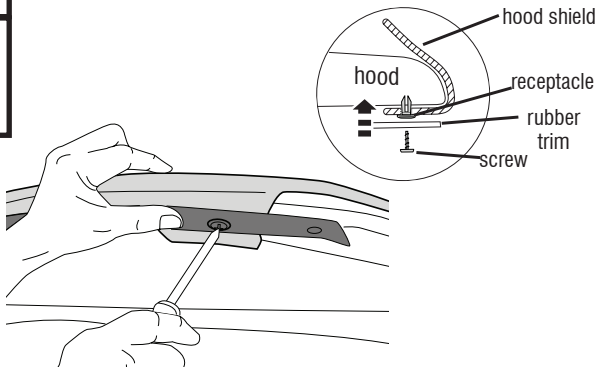

6



Lower hood, adjust hood bumper stops to ensure hood shield clears grille and headlights. Install bumper stops at pre-cleaned locations on the painted hood/fender surface.

7

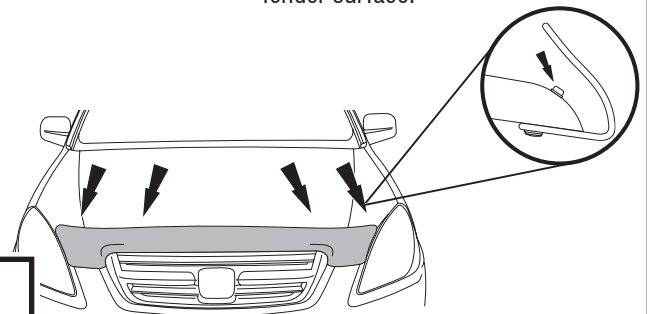

## Care and Cleaning

- Wash only with mild soap & dry with a clean cloth.

## Congratulations!

You have purchased one of the many quality Lund<sup>®</sup> branded products offered by Lund International, Inc. We take the utmost pride in our products and want you to enjoy years of satisfaction from your investment. We have made every effort to ensure that your product is top quality in terms of fit, durability, finish and ease of installation.

# LUND<sup>®</sup>

Lund International

800-241-7219 • Visit us at [lundinternational.com](http://lundinternational.com)

© 2016 Lund International, Inc. All rights reserved.

Lund<sup>®</sup> and the Lund<sup>®</sup> logo are trademarks of Lund International, Inc.



# LUND®

## Interceptor™

Pour obtenir une installation correcte et le meilleur ajustement possible, lire toutes les instructions AVANT de commencer. Pour toute assistance technique ou obtention de pièces manquantes, appeler le service des relations avec la clientèle au 1-800-241-7219.

### Informations importantes concernant la sécurité



- ATTENTION – Avant de conduire, s'assurer que le pare-insectes est solidement assujettie sur le véhicule.
- Ne pas utiliser les stations de lavage de voitures à brosse.
- Ne pas utiliser de solvants.
- Vérifier régulièrement le serrage des composants.

### Contenu **NOTE:** Le produit réel peut changer de l'illustration.



Protection de capot

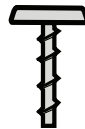

Vis  
x 4



Réceptacle  
x 4



4 gommés

### Outils nécessaires



Équipement  
de nettoyage



Linge propre



Tournevis  
Phillips



Crayon gras

### Préparation pour la peinture/l'installation

- Il est recommandé de procéder à un essai pour s'assurer que le positionnement et l'ajustement sont corrects.
- Vérifier l'ajustement des pièces avant peinture, car nous n'acceptons pas le retour de pièces modifiées ou peintes.
- Laver les glissières de glaces de la portière du véhicule pour éliminer toute poussière et tous débris.
- Sécher les glissières avec une serviette propre.

### Étapes d'installation

**REMARQUE :** La méthode d'application peut être légèrement différente de celle représentée par les illustrations.



Ouvrez le capot et nettoyez à fond le bord d'attaque du capot, puis laissez sécher.

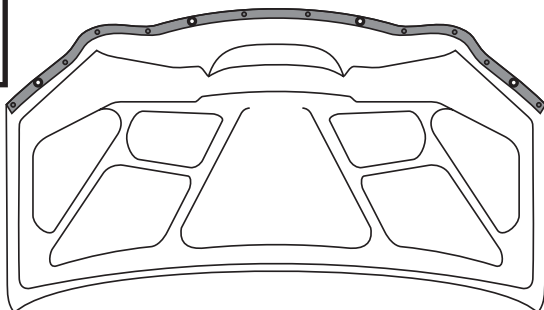

1



Vérifiez que le protecteur de capot sera bien ajusté en le centrant sur le rebord du capot. Repérez l'endroit où se trouveront les trous de fixation sur l'ailette du protecteur de capot et marquez-le avec un crayon gras.

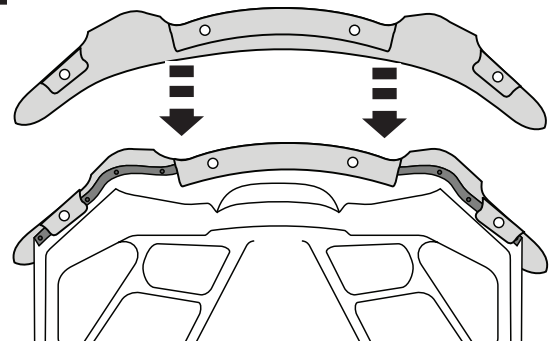

2

## Étapes d'installation

**REMARQUE :** La méthode d'application peut être légèrement différente de celle représentée par les illustrations.

Retirez les fixations correspondantes de la garniture en caoutchouc. Cette étape est nécessaire pour que les ailettes du protecteur de capot puissent se glisser **sous** la garniture en caoutchouc. **REMARQUE :** Il peut être nécessaire de retirer des fixations supplémentaires afin de recevoir l'ailette, selon la taille.

3

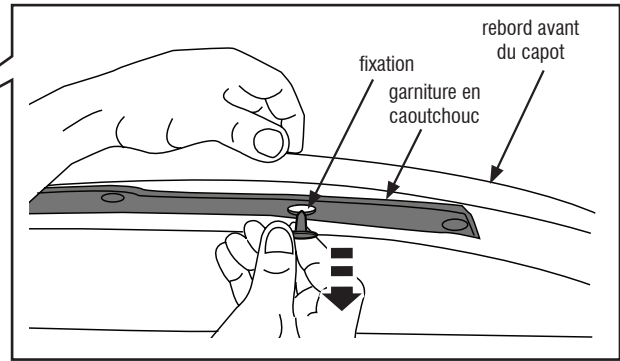
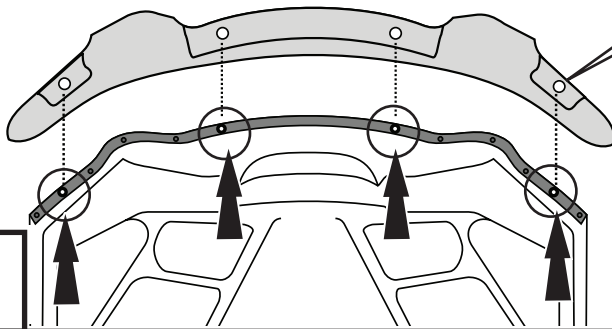

Positionnez le protecteur de capot de manière à glisser les ailettes **entre** le capot et le joint en caoutchouc. Alignez les trous.

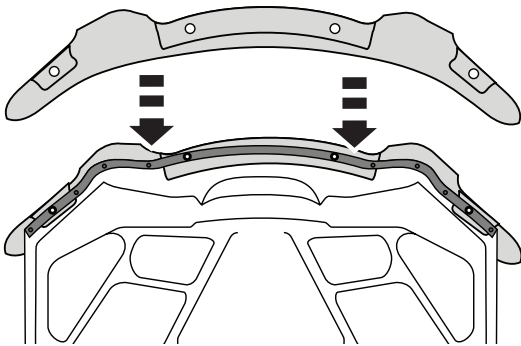

4



Insérez (4) des récipients de garniture en caoutchouc et à travers le pare, puis dans le capot.

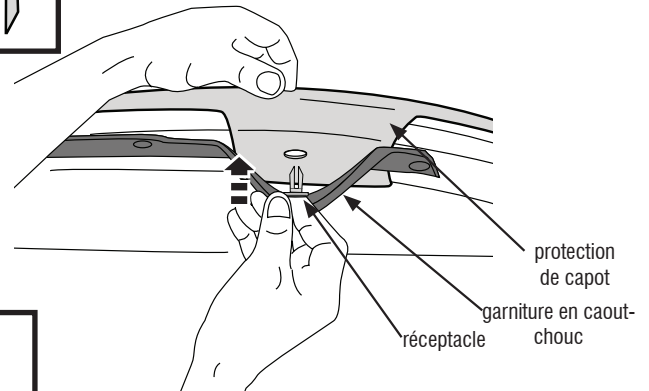

5



Insérez (4) vis à travers le caoutchouc assiette et dans des réceptacles et appliquer une pression tout en serrant la vis pour fixer à la hotte.

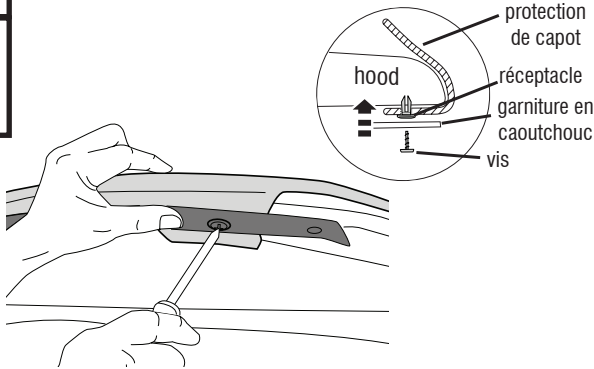

6



Abaissez le capot, ajuster les butoirs de pare-choc pour assurer que la protection du capot ne s'appuie pas sur la grille et les phares. Posez les gommés aux endroits pré-nettoyés sur la surface peinte du capot/de l'aile.

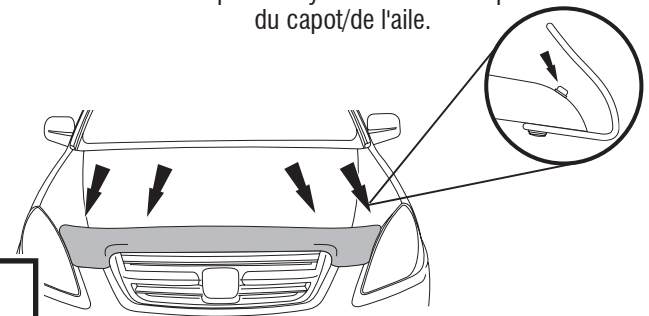

7

## Entretien et nettoyage

- Laver exclusivement avec de l'eau savonneuse et sécher avec un chiffon propre.

## Félicitations !

Vous venez d'acheter un des nombreux produits de qualité de la marque Lund<sup>®</sup> fabriqués par Lund International, Inc. Nous sommes extrêmement fiers de la qualité de nos produits et nous espérons que vous profiterez de cet investissement de longues années durant. Nous nous efforçons d'offrir la meilleure qualité en termes d'ajustement, de finition, de durabilité et de facilité d'installation.

# LUND<sup>®</sup>

Lund International

800-241-7219 • Visitez notre site [lundinternational.com](http://lundinternational.com)

© 2016 Lund International, Inc. Tous droits réservés.

Lund<sup>®</sup> et le logo Lund<sup>®</sup> sont des marques déposées de Lund International, Inc.



# LUND

## Interceptor™

**Para una instalación adecuada y el mejor ajuste posible, lea todas las instrucciones ANTES de comenzar. Si desea recibir asistencia técnica u obtener piezas faltantes, llame al Servicio al cliente al 1-800-241-7219.**

### Información importante de seguridad



- **PRECAUCIÓN** - Antes de conducir, asegúrese de que la visera deflectora esté correctamente anclada al vehículo.
- No utilice servicios automáticos de limpieza de vehículos que utilizan cepillos.
- No utilice limpiadores al solvente de ningún tipo.
- Compruebe periódicamente que todos los componentes estén ajustados.

### Contenido

**NOTA:** El producto real puede variar de la ilustración.



Cubierta del capó

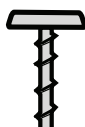

Tornillo  
x 4



Receptáculo  
x 4



Tope de  
goma x4

### Herramientas necesarias



Equipo de limpieza  
de vehículos



Toalla limpia

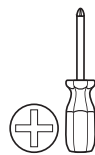

Destornillador  
Phillips



Lápiz de cera

### Preparación antes de pintar o instalar

- Se recomienda realizar un ajuste de prueba para asegurar el posicionamiento y ajuste correctos.
- Compruebe que las piezas se ajusten correctamente antes de pintarlas, ya que no aceptaremos la devolución de piezas modificadas o pintadas.
- Lave los canales de la ventanilla del vehículo para quitar los desechos y la suciedad.
- Seque los canales de la ventanilla con una toalla limpia.

### Pasos de instalación

**NOTA:** El uso real puede variar levemente de ilustraciones.



Levante el capó y limpie bien el borde anterior; deje secar.

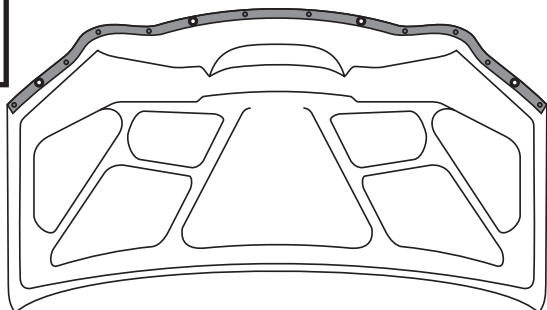

1



Pruebe el ajuste de la cubierta del capó centrándola sobre el borde del capó. Observe dónde estarán los orificios de montaje en el reborde de la cubierta del capó y marque con un lápiz de cera.

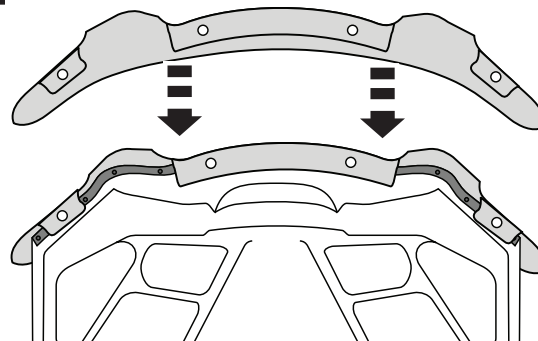

2

## Pasos de instalación

**NOTA:** El uso real puede variar levemente de ilustraciones.

Quite los sujetadores correspondientes de la banda de caucho. Esto es necesario para que los rebordes de la cubierta del capó se deslicen **por debajo** de la banda de caucho. **NOTA:** Puede ser necesario quitar otros sujetadores para acomodar el reborde, según el tamaño.

3

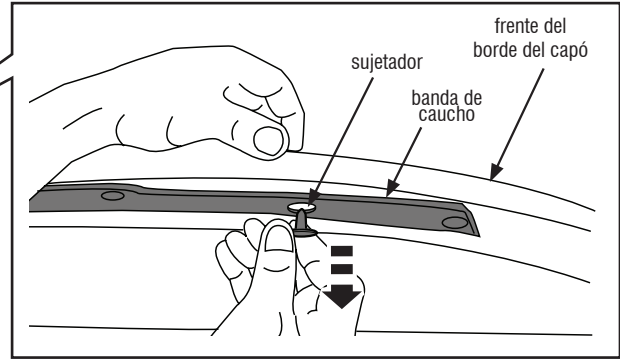
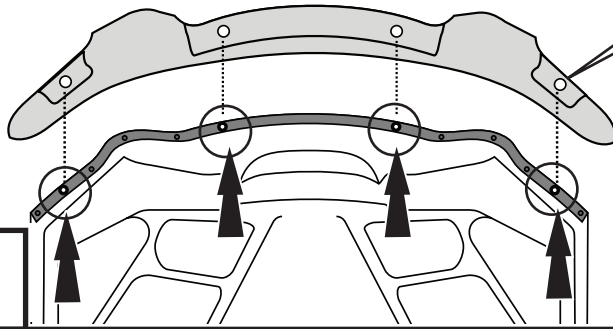

Coloque la cubierta del capó con los rebordes deslizándose **entre** el capó y la junta de caucho. Alinee los orificios.

4

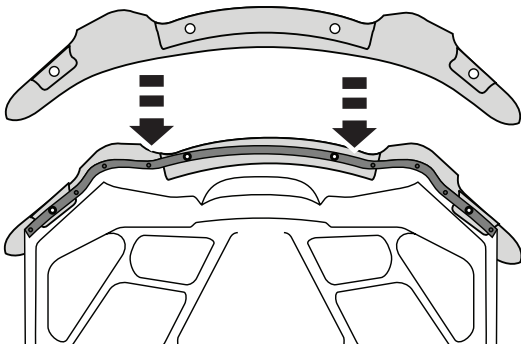

Inserte (4) receptáculos **BAJO** ajuste de goma y por medio de la cubierta para capó, y luego en la capilla.

5

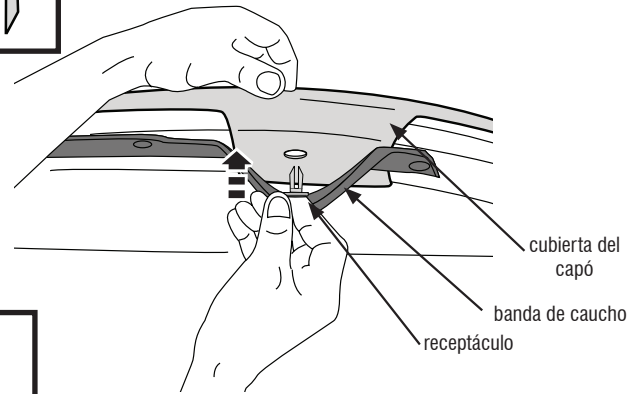

Insertar (4) tornillos a través de goma asiento y en los receptáculos y aplicar presión mientras aprieta el tornillo para asegurar a la campana.

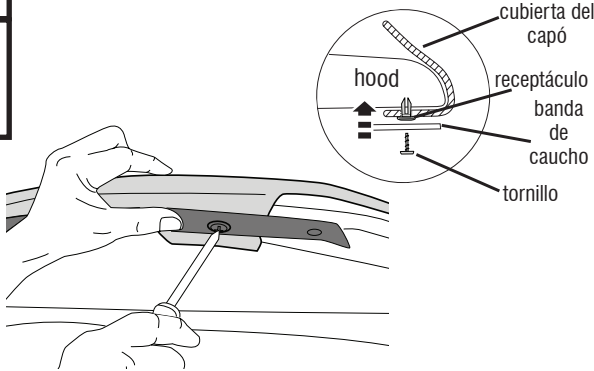
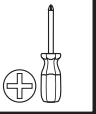

6



Baje el capó y ajuste los topes de goma para asegurarse de que la cubierta del capó no cubra la parrilla ni los faros delanteros. Instale los topes de goma en las partes limpias sobre la superficie pintada del capó/guardabarros.

7

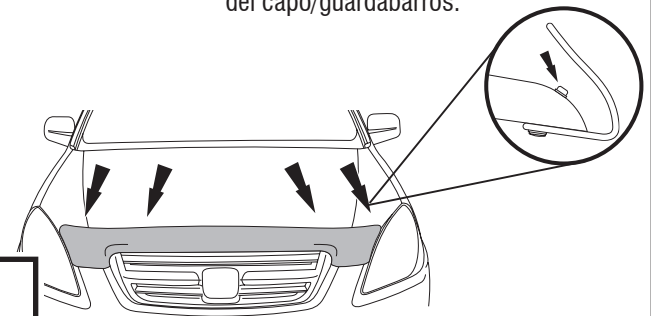

## Cuidado y limpieza

- Limpie solamente con agua jabonosa tibia y seque con un paño limpio.

## Felicidades

Usted ha adquirido uno de los tantos productos de calidad de marca Lund<sup>®</sup> que ofrece Lund International, Inc. Nos enorgullecen mucho nuestros productos y deseamos que disfrute años de satisfacción por su inversión. Nos hemos esforzado mucho para asegurarnos de que su producto sea de gran calidad en cuanto a ajuste, durabilidad, acabado y facilidad de instalación.

# LUND<sup>®</sup>

Lund International

800-241-7219 • Visite nuestro sitio Web: [lundinternational.com](http://lundinternational.com)

© 2016 Lund International, Inc. Todos los derechos reservados.

Lund<sup>®</sup> y el logo de Lund<sup>®</sup> son marcas registradas de Lund International, Inc.

