

Installation Instructions

I - Sheet Number I-PW00803303 Rev.A



Premium Style. Lasting Performance.

For proper installation and best possible fit, please read all instructions BEFORE you begin.
For technical assistance or to obtain missing parts, please call Customer Relations at 1-800-241-7219.

Para una instalación adecuada y el mejor ajuste posible, lea todas las instrucciones ANTES de comenzar.
Para obtener asistencia técnica o para obtener piezas que faltan, por favor llame a Relaciones con el cliente en 1-800-241-7219.

Pour une installation correcte et le meilleur ajustement possible, s'il vous plaît lire toutes les instructions AVANT de commencer.
Pour une assistance technique ou pour obtenir des pièces manquantes, s'il vous plaît communiquer avec les Relations à la clientèle au 1-800-241-7219.

Care and Cleaning

- **Wash only with mild soap & dry with a clean cloth.**
Lavar con jabón suave y seque con un paño limpio.
Laver avec un savon doux et séchez avec un chiffon propre.
- **Every 3 months or 5000 miles check the cover tension and all components for tightness.**
Revise cada 3 meses o 5,000 millas la tensión de la cubierta y todos los componentes estén ajustados.
Vérifiez tous les 3 mois ou 5000 miles la tension couvercle et le serrage des composants.

Congratulations!

You have purchased one of the many quality Lund® branded products offered by Lund International, Inc. We take the utmost pride in our products and want you to enjoy years of satisfaction from your investment. We have made every effort to ensure that your product is top quality in terms of fit, durability, finish and ease of installation.

Usted ha comprado uno de los muchos productos de calidad ofrecidos por Lund® de marca productos ofrecidos por Lund International, Inc. Tomamos el orgullo extremo en nuestros productos y queremos que disfrute durante años de su inversión. Hemos hecho todos los lo posible para que su producto es de calidad superior en cuanto a ajuste, durabilidad, acabado y facilidad de la instalación.

Vous avez acheté un des nombreux produits de qualité offerts par Lund® marque produits offerts par Lund International, Inc Nous sommes extrêmement fiers de nos produits et souhaitons que vous tiriez des années de satisfaction de votre investissement. Nous avons pris toutes les efforts pour s'assurer que votre produit est de qualité supérieure en termes de durabilité, de finition et la facilité de l'installation.

INSTALLATION INSTRUCTIONS

PART# 244115033/ 260115033

PARTS LIST:

Qty	Description	Qty	Description
1	Driver/Left Sidebar	8	12mm Lock Washers
1	Passenger/Right Sidebar	8	12mm Hex Nuts
3	Driver/Left 1 st , 2 nd & 3rd Mounting Brackets	8	10-1.5mm x 35mm Hex Bolts
3	Passenger/Right 1 st , 2 nd & 3rd Mounting Brackets	8	10mm x 27mm OD x 3mm Flat Washers
1	Driver/Left Rear Fourth Bracket	8	10mm Lock Washers
1	Passenger/Right Rear Fourth Bracket	16	8-1.25 x 25mm Hex Bolts
8	12mm Plastic Retainers	16	8mm x 24mm x 2mm Flat Washers
8	12mm x 35mm Bolt x 10mm Nut Plates	16	8mm Lock Washers
8	12mm x 32mm OD x 3mm Flat Washers		

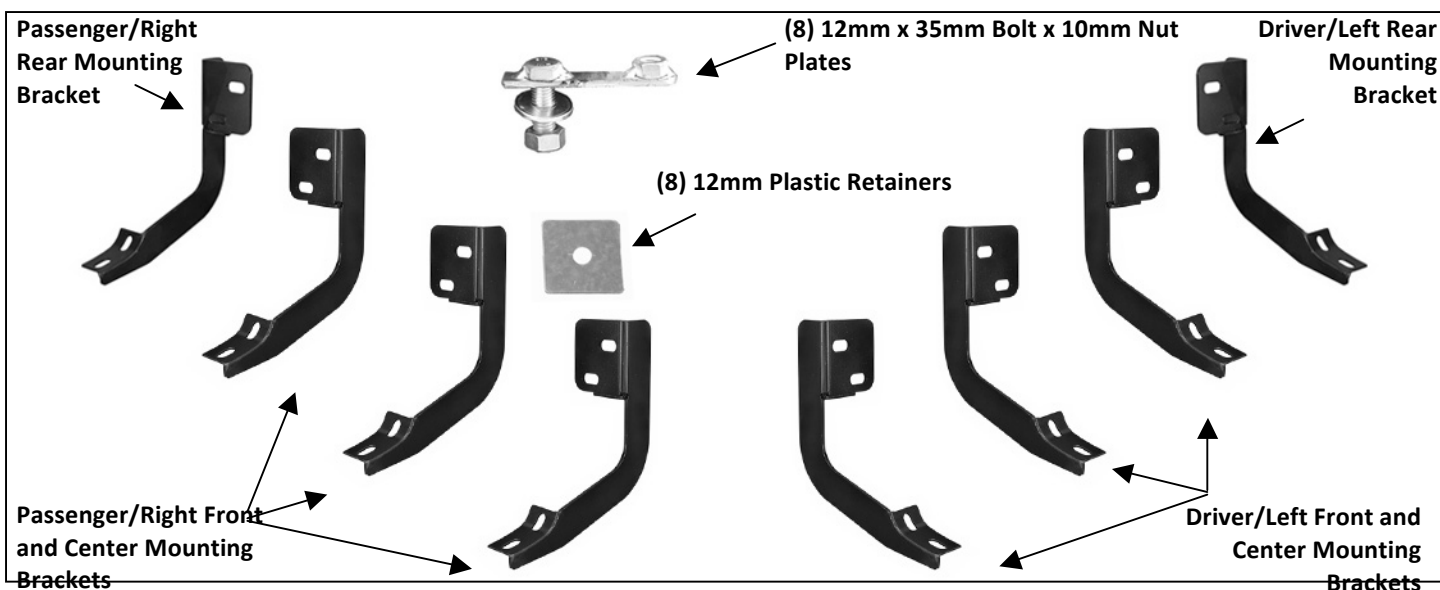

PROCEDURE:

- REMOVE CONTENTS FROM BOX. VERIFY ALL PARTS ARE PRESENT. READ INSTRUCTIONS CAREFULLY BEFORE STARTING INSTALLATION. DRILLING IS OPTIONAL.**
- Starting at the driver side-front of the vehicle, remove the sealing tape covering the factory holes on the side of the inner panel, **(Figure 1)**. Partially thread (1) 12mm Plastic Retainer onto the threaded end of (1) 12mm Bolt and Nut Plate, **(Figure 2)**. Insert the Bolt and Nut Plate into the factory oval hole. Continue to thread the Plastic Retainer down the Bolt and Nut Plate until it is flush against the sheet metal, **(Figure 3)**. **NOTE:** When properly installed, the Plastic Retainer will prevent the Bolt and Nut Plate from falling into the body cavity during installation.
- Select the driver side front Mounting Bracket and hang it from the Bolt and Nut Plate with (1) 12mm Flat Washer, (1) 12mm Lock Washer and (1) 12mm Hex Nut, **(Figure 4)**. Do not tighten hardware at this time. Line up the remaining hole in the Mounting Bracket with the hole in the body panel. Rotate the Bolt and Nut Plate until the threaded end, (Nut), lines up with the hole in the Mounting Bracket. Secure the Bracket with (1) 10mm x 35mm Hex Bolt, (1) 10mm Lock Washer and (1) 10mm Flat Washer, **(Figure 5)**. Snug but do not tighten hardware at this time.
- Repeat **Steps 2 - 3** for the center-front and center-rear Mounting Bracket installation.

5. Once the (3) driver side Brackets have been installed, carefully position the driver Sidebar onto the Mounting Brackets. Attach the Sidebar to the cradles on the Mounting Brackets with the included (6) 8mm x 25mm Hex Bolts, (6) 8mm Lock Washers, and (6) 8mm Flat Washers, **(Figure 6)**. Do not tighten hardware at this time.
IMPORTANT: If you are having any difficulty with installation, check Mounting Bracket location first. Use the illustration on **Page 1** to identify the Mounting Brackets.
6. Insert (1) 12mm Bolt and Nut Plate with Plastic Retainer into the hole in the rear corner of the cab as described in Step 2, **(Figures 7 & 8)**. Select the driver side Rear Mounting Bracket, **(Figure 9)**. **NOTE:** The rear Bracket looks similar to the other Brackets but they are unique and only designed to fit the rear mounting location. Hang the Rear Bracket from the Bolt Plate with (1) 12mm Flat Washer, (1) 12mm Lock Washer and (1) 12mm Hex Nut, **(Figure 10)**. Leave hardware loose. Attach the Bracket to the Sidebar with (2) 8mm Hex Bolts, (2) 8mm Lock Washers and (2) 8mm Flat Washers, **(Figure 6)**. Properly level and adjust the Sidebar and tighten all hardware at this time.
7. **Optional Rear Bracket Installation**-requires drilling-highly recommended for heavy duty use:
 - a. Once **Step 6** has been completed, loosen the Hex Nut on the Bolt Plate and center the threaded end in the slot in the Bracket and the vehicle, **(Figures 8 & 10)**. Trace the open, unused slot in the bracket mounting plate onto the body panel, **(Figure 10)**. Remove the Rear Bracket and Bolt Plate, **(Figure 11)**. Mark the center of the slot. Carefully drill the location with a 7/16" drill bit, **(Figure 12)**. Reinstall the Bolt Plate and Bracket as previously described in **Steps 2 - 3 & 6, (Figure 13)**. Tighten all hardware.

IMPORTANT! Any cutting or drilling tool may break or shatter. Government regulations require safety glasses & equipment at all times when cutting or drilling.

8. Repeat **Steps 2 – 6 (or 7)** for passenger Sidebar installation.
9. Do periodic inspections to the installation to make sure that all hardware is secure and tight.

To protect your investment, wax this product after installing. Regular waxing is recommended to add a protective layer over the finish. Do not use any type of polish or wax that may contain abrasives that could damage the finish.

For stainless steel: Aluminum polish may be used to polish small scratches and scuffs on the finish. Mild soap may be used also to clean the Sidebar.

For gloss black finishes: Mild soap may be used to clean the Sidebar.

Driver Side Installation Pictured

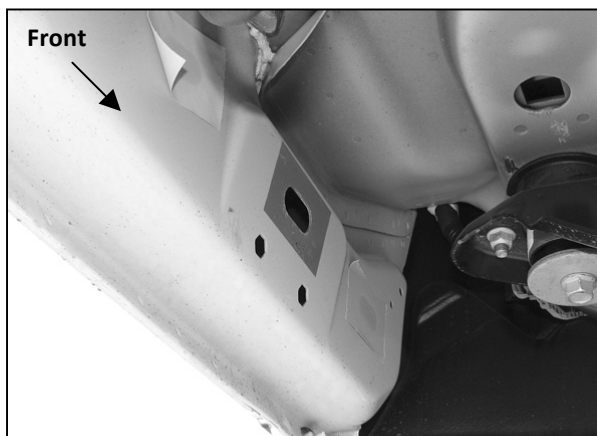

(Fig 1) Driver/Left front mounting location pictured

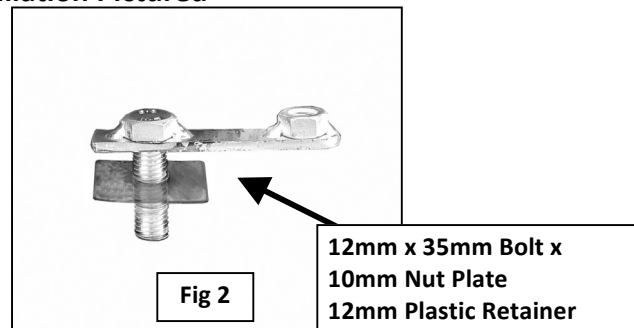

**12mm x 35mm Bolt x
10mm Nut Plate
12mm Plastic Retainer**

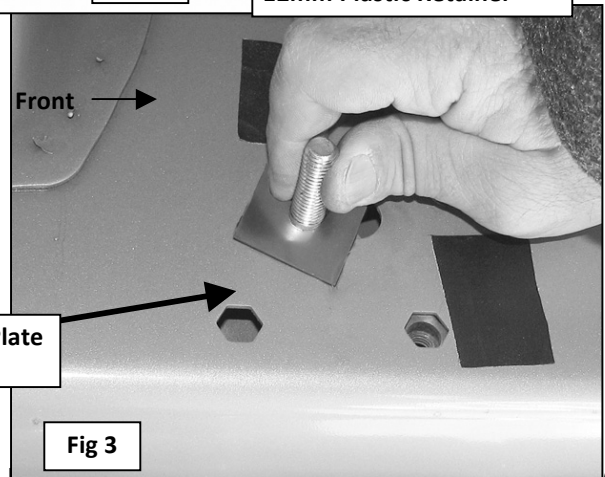

**12mm x 35mm Bolt x 10mm Nut Plate
w/ 12mm Plastic Retainer**

Driver Side Installation Pictured

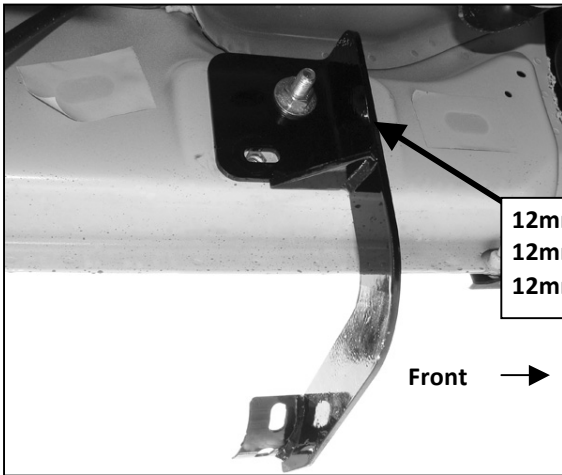

12mm Flat Washer
 12mm Lock Washer
 12mm Hex Nut

Front →

(Fig 4) Driver/Left front Mounting Bracket

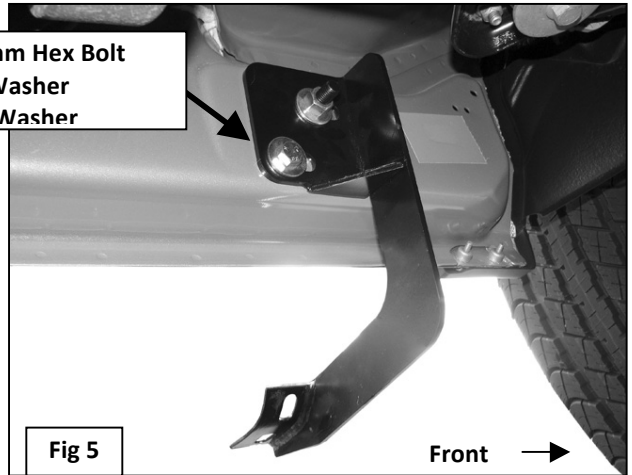

10mm x 30mm Hex Bolt
 10mm Flat Washer
 10mm Lock Washer

Fig 5

Front →

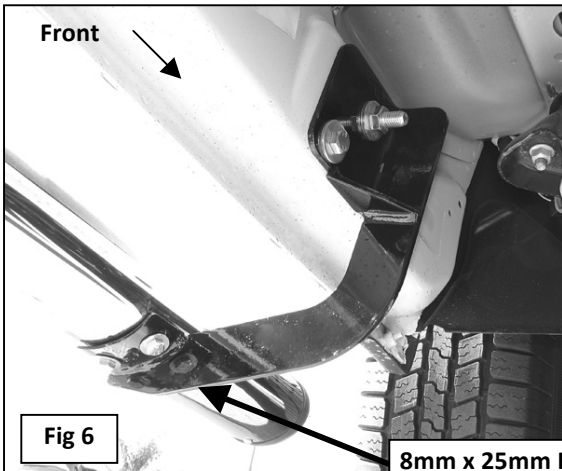

Front →

Fig 6

8mm x 25mm Hex Bolts
 8mm Flat Washers
 8mm Lock Washers

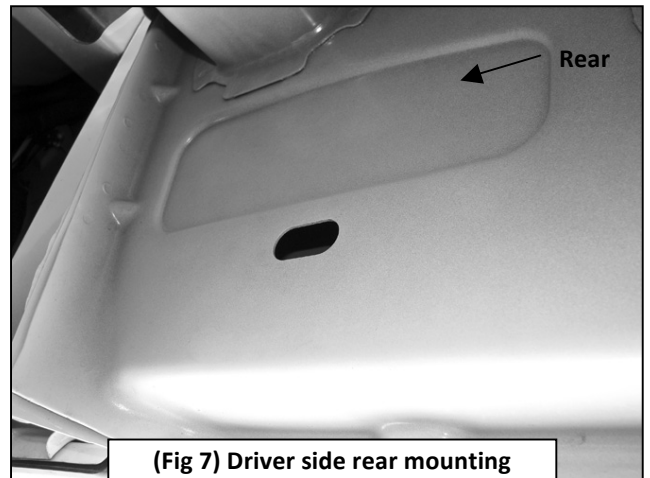

Rear →

(Fig 7) Driver side rear mounting location at end of cab

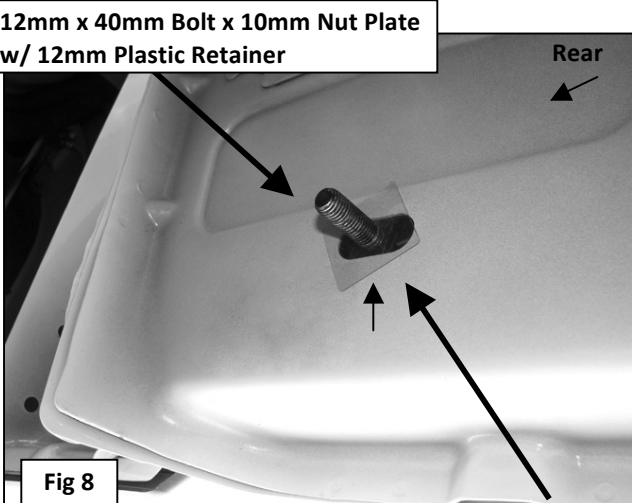

12mm x 40mm Bolt x 10mm Nut Plate
 w/ 12mm Plastic Retainer

Rear →

Fig 8

Try to keep the Bolt Plate in the center of the slot
 when installing the rear Bracket only

IMPORTANT: The rear Mounting Brackets look similar to the front and center brackets but they are unique. Note the reversed mounting plate and rear facing cradle for the Sidebar.

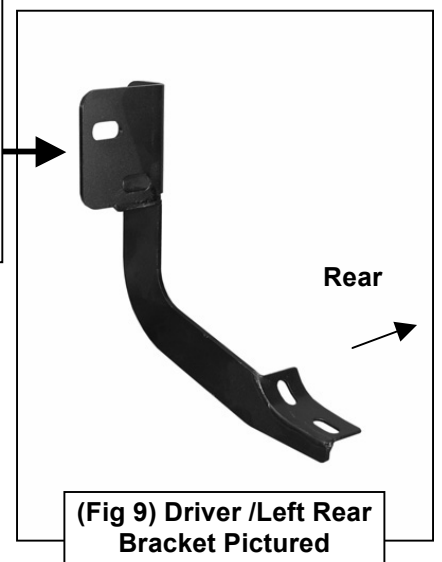

Rear →

(Fig 9) Driver /Left Rear Bracket Pictured

5" OVAL WHEEL TO WHEEL SIDEBARS
10-13 DODGE RAM 25-3500 MEGA CAB 6-1/2FT BED
EXCLUDES MODELS WITH DUAL REAR WHEELS

Driver Side Installation Pictured

12mm Flat Washer
12mm Lock Washer
12mm Hex Nut

Trace the slot with a marker.
Locate approximate center of
slot and mark to drill

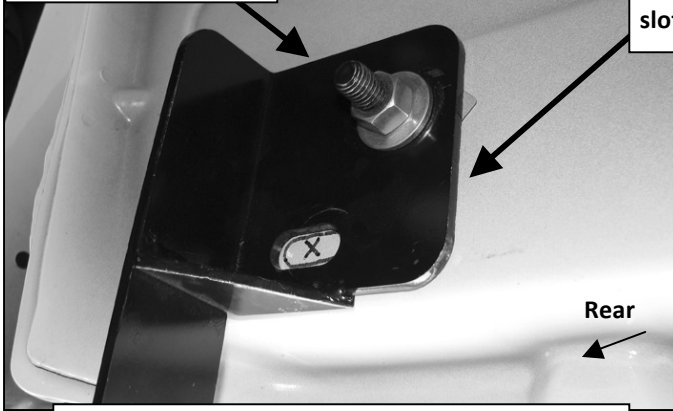

(Fig 10) Driver/Left rear Mounting Bracket

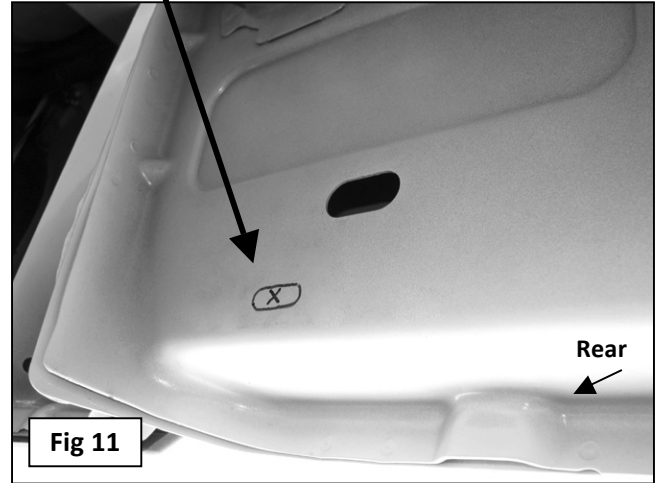

Fig 11

Use a 7/16" drill bit to drill hole in
center of slot as marked

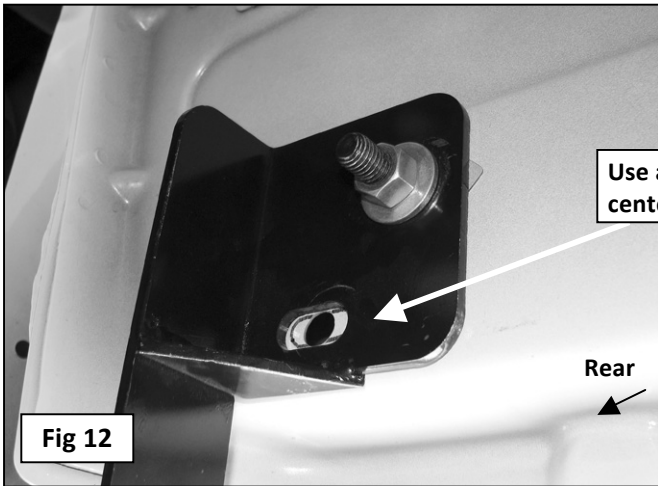

Fig 12

12mm Flat Washer
12mm Lock Washer
12mm Hex Nut

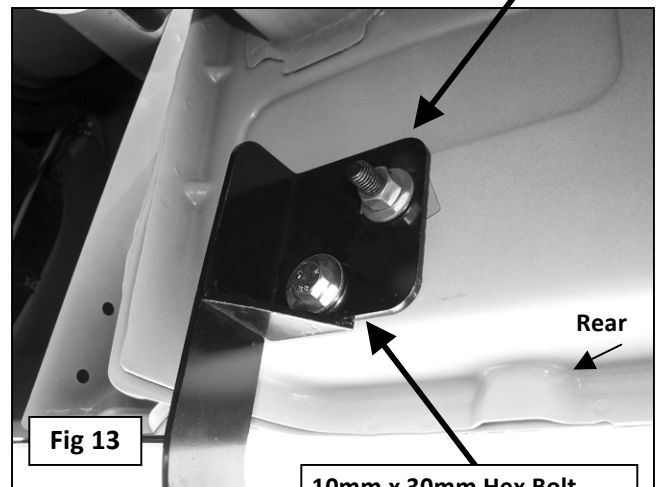

Fig 13

10mm x 30mm Hex Bolt
10mm Flat Washer
10mm Lock Washer



Complete Installation