

INSTALLATION INSTRUCTIONS AND PARTS LIST

APPLICATION: MODEL **481143** (STAINLESS STEEL) SIDE ENTRY STEP BOARDS ON:
BODY MOUNT APPLICATION

1. READ INSTRUCTIONS COMPLETELY AND CHECK TO MAKE SURE THAT ALL REQUIRED PARTS (LISTED ON SERVICE PARTS LIST) ARE ON HAND BEFORE STARTING THE INSTALLATION.
2. WITH THE STEP BOARD BRACKETS ATTACHED TO THE VEHICLE, ON THE LEFT SIDE OF THE VEHICLE PLACE THE STEP BOARD (ITEM #1) ON THE BRACKETS AND CHECK THAT THE MOUNTING HOLES LINE UP. (LUVERNE STICKER SHOULD BE ON THE FRONT DRIVERS SIDE)
3. USING SIX (6) 10-24 X .75" CARRIAGE BOLTS (ITEM #3), AND SIX (6) 10-24 FLANGE NUTS (ITEM #4) ATTACH THE STEP BOARD TO THE BRACKETS.
4. ADJUST STEP IN/OUT TO ALIGN STEP WITH THE CAB.
5. TIGHTEN THE STEP MOUNTING BOLTS.
6. REPEAT FOR RIGHT SIDE OF VEHICLE.

SERVICE PARTS LIST

ITEM	PART NO.	QTY	DESCRIPTION
1	551845	1	STEP PLATE-SES,LH,481143
2	551844	1	STEP PLATE-SES,RH,481143
3	104258	12	BOLT – CARRIAGE – SST, 10-24 X .75"
4	104261	36	NUT – FLANGE, SST, 10-24
5	104250	2	END CAP – RH FRONT/LH REAR
6	104251	2	END CAP – LH FRONT/RH REAR
7	102502	2	TRIM – SEAL, EXTRUSION, 95"
8	105500	2	STEP PAD, 5.50 X 20.00
9	104257	8	NUT – HEX, SINGLE THREAD
10	107958	4	SCR-PPH, #8-18 X .5", SST
11	107645	2	CLIP-U, .118-.185, BLK
12	107863	24	BOLT – CARRIAGE, 10-24 X .5", BZP



(A LUVERNE Company)

1200 E. Birch St.

Brandon, SD 57005

552669 SHEET 1 OF 2 20OCT14

INSTALLATION INSTRUCTIONS AND PARTS LIST

APPLICATION: MODEL **581143** (STAINLESS STEEL) SIDE ENTRY STEP BRACKETS ON:
1999-2013 GM 1500 EXTENDED CAB AND CREW CAB PICKUPS, GAS
2001-2014 GM 2500/3500HD EXTENDED CAB AND CREW CAB PICKUPS, GAS/DIESEL
BODY MOUNT APPLICATION



NO DRILL APPLICATION

1. READ INSTRUCTIONS COMPLETELY AND CHECK TO MAKE SURE THAT ALL REQUIRED PARTS (LISTED ON SERVICE PARTS LIST) ARE ON HAND BEFORE STARTING THE INSTALLATION.
2. ON THE LEFT SIDE OF THE VEHICLE PREASSEMBLE THE FRONT BRACKET (ITEMS #2, 4) AS SHOWN IN **FIG. 1** USING THREE 3/8"-16 X 1.0" SCREWS, 3/8" FLAT WASHER AND 3/8" FLANGE NUTS (ITEMS #15, 12, 13). TORQUE TO 19 LB. FT. **NOTE: IF INSTALLING ON A 1500 PICKUP YOU MUST ATTACH THE SMALL 90° BRACKET (ITEM #16) TO THE FRONT BRACKETS (SEE FIG 1.)**
3. ASSEMBLE THE LOAD REACTION STUDS AND HARDWARE (ITEM #11 THRU #14) AS FOLLOWS.
 - 3.1. ON THE SHORT THREADED END OF THE LOAD REACTION STUD (ITEM #14), INSTALL A 3/8" SERRATED FLANGE NUT (ITEM #13) BACKWARDS TO THE BOTTOM OF THE THREAD. THEN INSTALL A 3/8" FLAT WASHER (ITEM #12) AND RUBBER "CUSHION" WASHER (ITEM # 11) TIGHT UP AGAINST THE SERRATED FLANGE NUT. (THE END OF THE STUD MUST BE RECESSED IN THE RUBBER WASHER APPROX. 3/16").
 - 3.2. ON THE LONG THREADED END OF THE STUD, INSTALL A 3/8" SERRATED FLANGE NUT (ITEM #13) BACKWARDS TO NEAR TO THE BOTTOM OF THE THREADS
4. ATTACH THE LOAD REACTION STUD ASSEMBLIES TO THE MOUNTING BRACKETS AS SHOWN IN **FIG. 4**. INSERT THE STUD, FROM WHAT WILL BE THE INBOARD OR FRAME SIDE THRU THE LOWEST HOLE IN THE BENT FLANGE OF THE BRACKET THAT WILL ALLOW THE RUBBER WASHER TO SEAT FIRM AGAINST THE SIDE WALL OF THE FRAME. INSTALL A 3/8" SERRATED FLANGE NUT (ITEM #13) ON THE OUTBOARD END OF THE STUD (FINGER TIGHT ONLY).

NOTE:

DUE TO EXCESSIVE THREAD LOCKER IN THE BODY MOUNT BOLT AREA ON THE 2010+ GM SILVERADO/SIERRA, USE CAUTION WHEN REMOVING THE BODY MOUNT BOLTS.

5. REMOVE THE FACTORY FRONT, CENTER, AND REAR BODY MOUNT BOLTS AND INSTALL THE MOUNTING BRACKETS PER THE FOLLOWING INSTRUCTIONS:
 - 5.1. INSTALL THE FRONT MOUNTING BRACKET (ITEMS #2, 4) TO THE FRONT BODY MOUNT AS SHOWN (LEAVE THESE FASTENERS FINGER TIGHT).
 - 5.2. INSTALL THE CENTER MOUNTING BRACKET (ITEM #5) TO THE CENTER BODY MOUNT AS SHOWN (LEAVE THESE FASTENERS FINGER TIGHT).
 - 5.3. INSTALL THE REAR MOUNTING BRACKET (ITEM #9) & WASHER (ITEM #17) TO THE REAR BODY MOUNT AS SHOWN (LEAVE THESE FASTENERS FINGER TIGHT).
 - 5.4. ATTACH THE REAR OUTBOARD MTG BRKT (ITEM #7) TO THE REAR INBOARD MTG BRKT (ITEM #9), USING THREE 3/8"-16 X 1.0" SCREWS, 3/8" FLAT WASHERS AND 3/8" FLANGE NUTS. (ITEMS #15, 12, 13). THE REAR OUTBOARD MOUNTING BRACKET MUST BE MOUNTED TO THE BACK SIDE OF THE REAR INBOARD MOUNTING BRACKET (TOWARDS THE REAR OF THE VEHICLE) AS SHOWN IN FIG 2 AND 3. BE SURE TO USE THE CORRECT HOLES AS SHOWN IN FIG. 2 & 3. NOTE THAT THERE IS A DIFFERENCE BETWEEN THE EXTENDED CAB AND CREW CAB APPLICATIONS. TORQUE THE BOLTS TO 19 LB. FT.



1200 E. Birch St.

Brandon, SD 57005

552691 SHEET 1 OF 4 04NOV14

6. INSTALL THE STEP BOARDS AS DESCRIBED BY THE INSTRUCTIONS INCLUDED WITH YOUR STEP BOARDS. (NOTE: INSURE THAT THE MOUNTING BRACKETS DO NOT TOUCH THE INSIDE WALL OF THE BODY MOUNT HOUSING AND TORQUE THE BODY MOUNT FASTENERS TO MANUFACTURES SPECS).
7. POSITION THE LOAD REACTION BOLT ASSEMBLY SO THAT THE RUBBER CUSHION IS SNUG UP AGAINST THE SIDE OF THE FRAME. TIGHTEN THE 3/8" FLANGE NUTS ON EITHER SIDE OF THE BRACKET TO 19LB. FT.
8. REPEAT STEPS 1-7 FOR THE RIGHT SIDE OF THE VEHICLE.

ATTACHING THE STEP BOARDS TO THE BRACKETS:

PLEASE REFER TO THE INSTRUCTION SHEET INCLUDED WITH YOUR STEP BOARD ASSEMBLY TO MOUNT THE STEP TO THE BRACKETS.

SERVICE PARTS LIST

ITEM	PART NO.	QTY	DESCRIPTION
1	481142	1	STEP ASSEMBLY, SES, EXTENDED CAB (MOD. 481142)
1	481143	1	STEP ASSEMBLY, SES, CREW CAB (MOD. 481143)
2	551835	1	BRACKET-MTG, FRONT, LH, SES, 581143
3	551834	1	BRACKET-MTG, FRONT, RH, SES, 581143
4	551831	2	BRACKET-MTG, FRONT, INBOARD, 581143
5	551815	1	BRACKET-MTG, CENTER, LH, SES, 581143
6	551818	1	BRACKET-MTG, CENTER, RH, SES, 581143
7	551816	1	BRACKET-MTG, REAR, LH, SES, 581143
8	551819	1	BRACKET-MTG, REAR, RH, SES, 581143
9	551826	2	BRACKET-MTG, REAR, INBOARD, LH/RH, 581143
11	102592	6	WSHR, RUBBER, .354 ID X 1.00 OD X .75 THK
12	100062	18	WSHR, FL, 3/8", .438 ID X 1.00 OD X .083" THK
13	100181	30	NUT, SERR FLG, HEX, 3/8-16 UNC, ZP
14	104686	6	STUD, -DBL ENDED, STL, 3/8-16 X 4.00", ZP
15	100040	12	SCR-HEX HD, 3/8-16 UNC, ZP
16	551571	2	BRACKET-90 DEGREE, 3 HOLE
17	108882	2	WSHR, FL, .59 ID X 1.06 OD X .19 THK, ZP



1200 E. Birch St. Brandon, SD 57005

SERVICE PARTS LIST
 MODEL NO. 581143

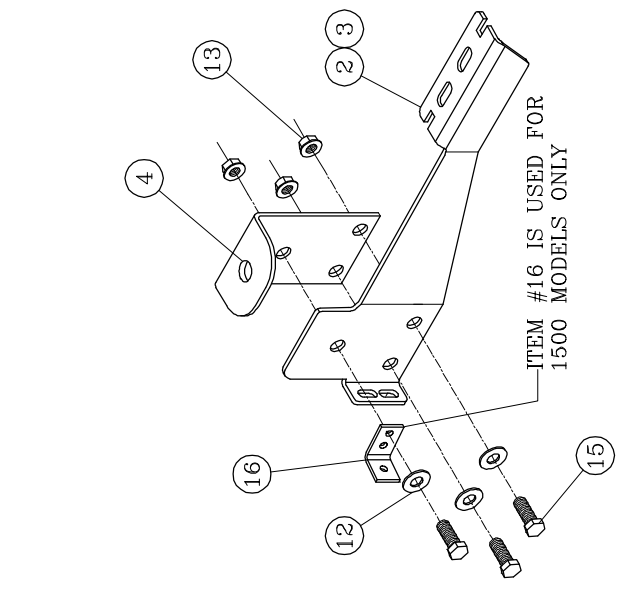

FRONT BRACKET ASSEMBLY

FIG. 1

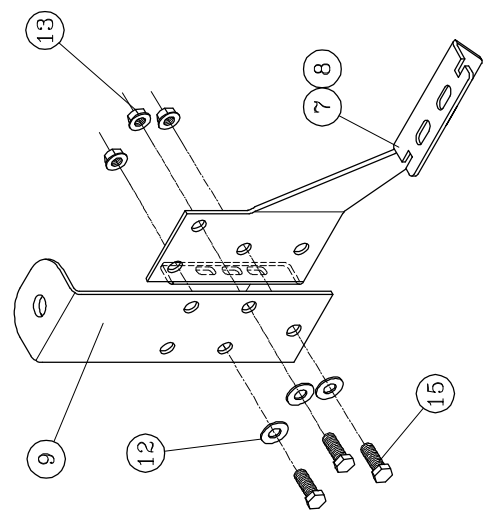

EXTENDED CAB REAR BRACKET ASSEMBLY

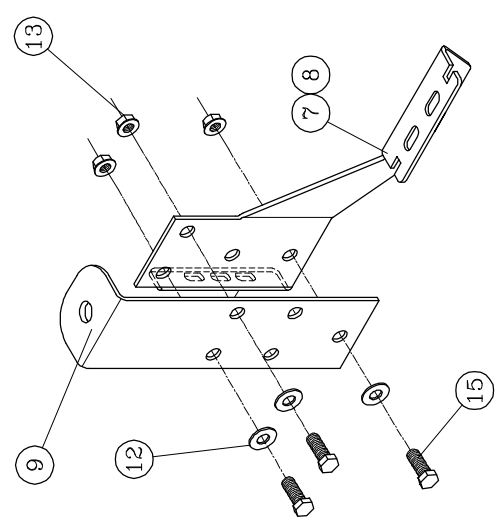

CREW CAB REAR BRACKET ASSEMBLY

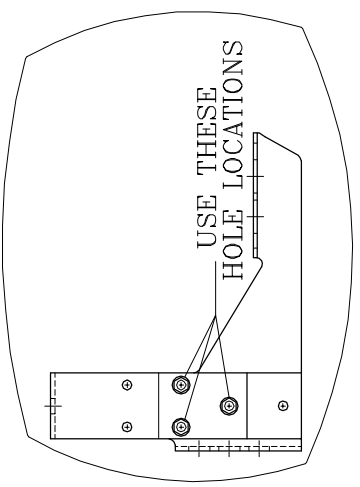

FIG. 2

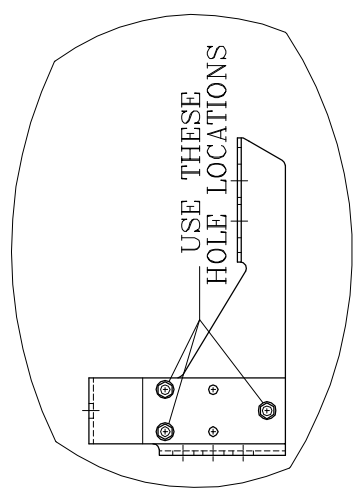

FIG. 3

SERVICE PARTS LIST

MODEL NO. 581143

GM EXTENDED CAB GM CREW CAB

FIG. 4

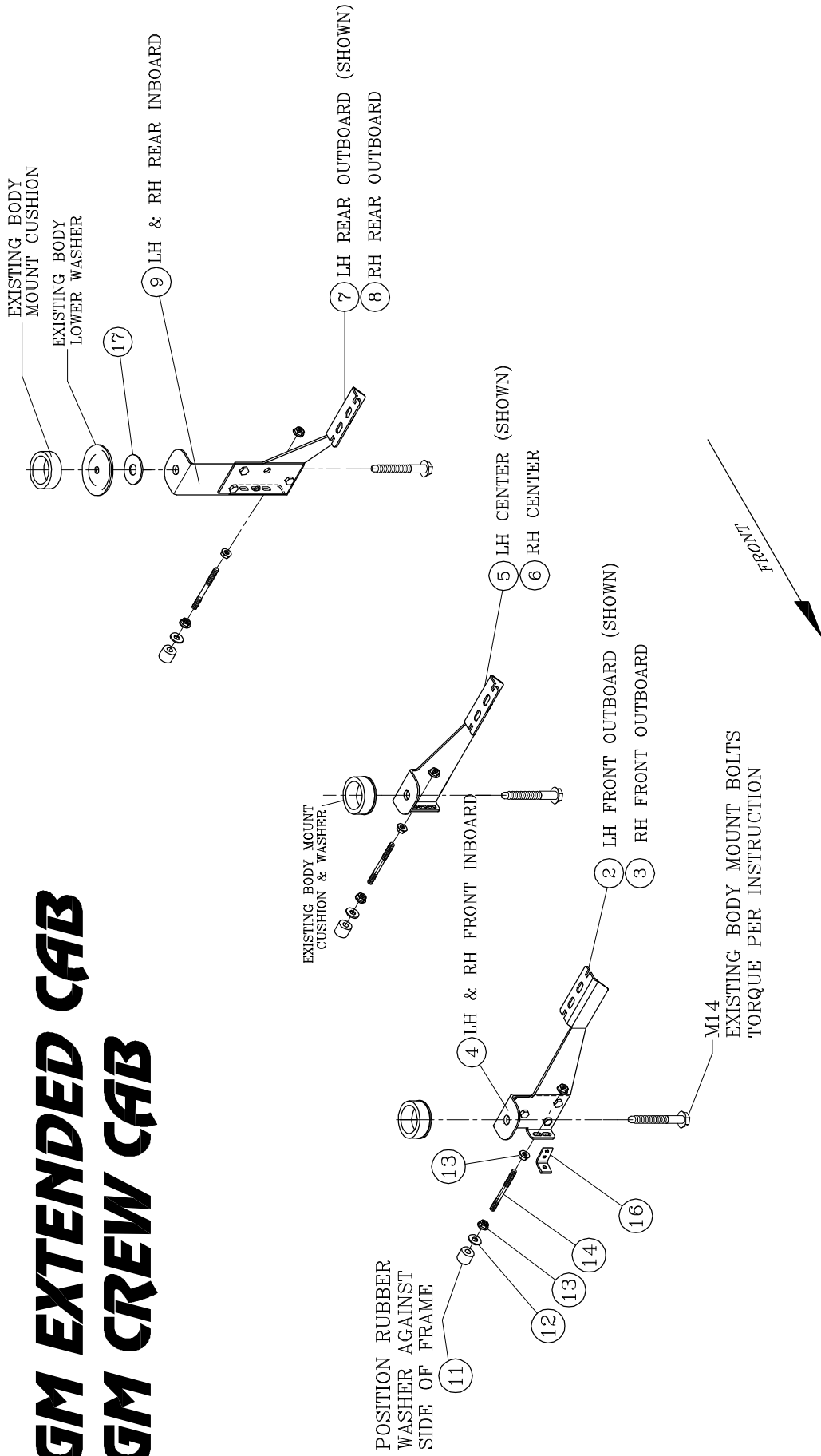

LEFT (DRIVER) SIDE SHOWN
-RIGHT (PASSENGER) SIDE OPPOSITE-



1200 E. Birch St.
Greenville, SD 57105

SERVICE PARTS LIST

MODEL NO. 481143

GM CREW CAB

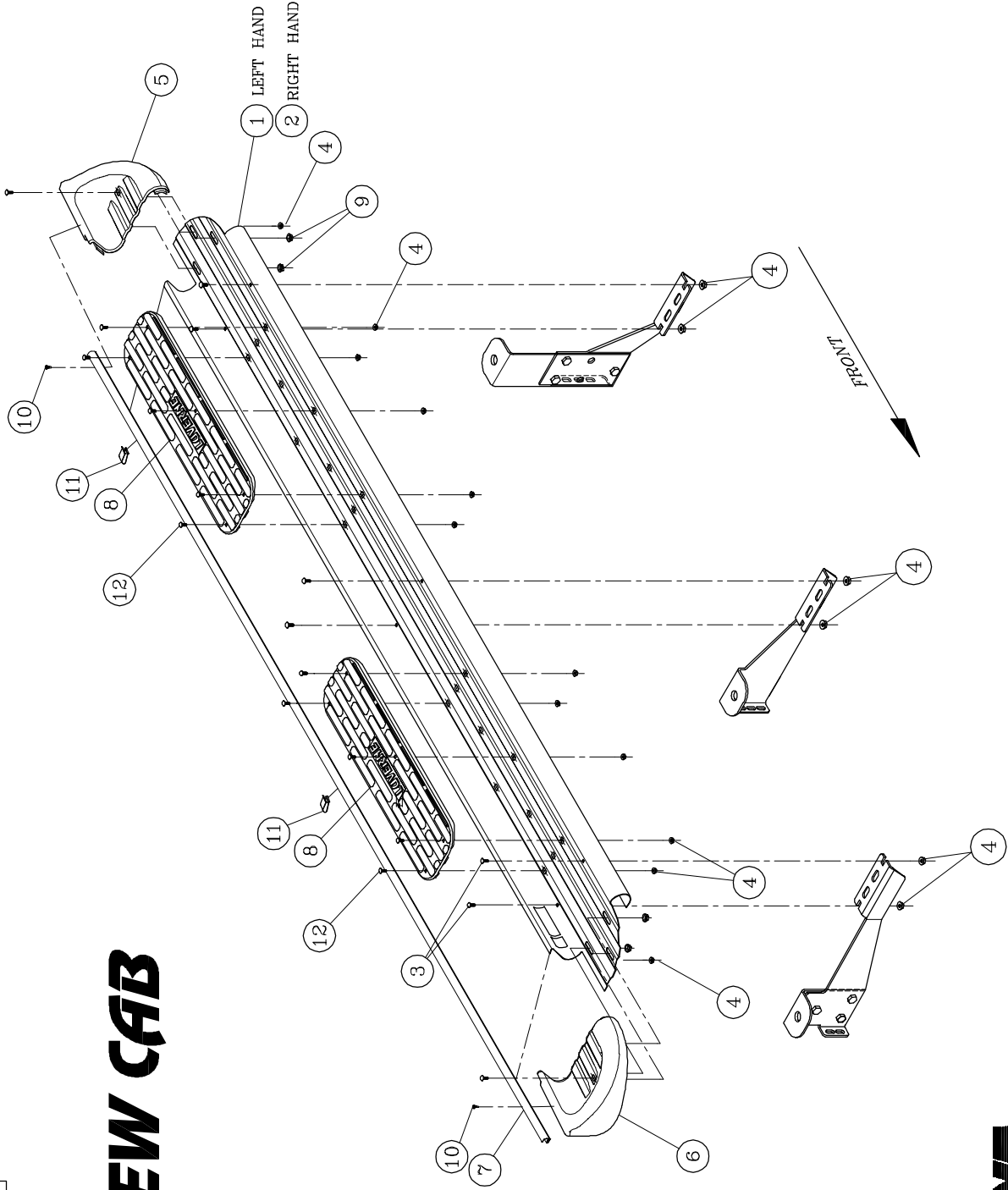

LEFT (DRIVER) SIDE SHOWN
-RIGHT (PASSENGER) SIDE OPPOSITE-

LOVERNE
TRUCK & EQUIPMENT
(A LOVERNE COMPANY)
1280 E. 21st St. Spindon, GB S7005