

# INSTALLATION INSTRUCTIONS AND PARTS LIST

MODEL: 583098, 583102, 583108, 583114, 583125, 584098, 584102, 584114, 584125 O-MEGA II 6" OVAL  
STEPS  
UNIVERSAL APPLICATION

1. READ INSTRUCTIONS COMPLETELY AND CHECK TO MAKE SURE THAT ALL REQUIRED PARTS (LISTED ON THE SERVICE PARTS LIST) ARE ON HAND BEFORE STARTING THE INSTALLATION.
2. FOLLOW THE INSTRUCTIONS INCLUDED WITH THE SPECIFIC BRACKET PACKAGE THAT YOU ARE USING, TO MOUNT THE BRACKETS TO YOUR VEHICLE.
3. BEFORE ATTACHING THE O-MEGA STEPS TO THE BRACKETS, PLACE THE STEP PADS (ITEM #2) ON TOP OF THE STEP PLATES. USE THE TABLE ON SHEET #2, AS A GUIDE TO POSITION THE STEP PAD FOR YOUR PARTICULAR VEHICLE. WHEN INSTALLING THE PADS ON THE STEPS, DRILL (5) 1/8" HOLE USING THE STEP PAD AS A GUIDE. ATTACH WITH (5) 8-18X1/2" TEK SCREWS (ITEM #6) PROVIDED. REPEAT FOR ALL STEP PADS. (NOTE: DUE TO THE SHORTNESS OF SOME BOXES, MOUNT THE BOX STEP PAD FIRST, APPROXIMATELY 1/2" FROM THE END CAP AND THEN MOUNT THE MIDDLE STEP PAD ACCORDINGLY.)
4. INSTALL THE REQUIRED NUMBER OF SQUARE HEAD BOLTS INTO THE DESIGNATED SLOTS IN THE BOTTOM OF THE STEP PLATES.
5. INSTALL THE END CAPS (ITEM #3) AS SHOWN IN *fig. 1*, TIGHTENING THE NUTS TO 5 LB FT.
6. POSITION THE O-MEGA STEP ON THE MOUNTING BRACKETS SO THAT THE SQUARE HEAD SCREWS (ITEM #4) ARE LOCATED IN THE SLOTS OF THE MOUNTING BRACKETS AND THE STEP IS CENTERED, FRONT TO REAR, ON THE VEHICLE. INSTALL 5/16" SERRATED FLANGE NUTS (ITEM #5) ON THE SQUARE HEAD SCREWS (ITEM #4) AND TIGHTEN TO 19 LB FT.

## SERVICE PARTS LIST

ITEM	PART NO.	QTY	DESCRIPTION
1	553074	2	EXTRUSION-AL,95.0,OMEGA STP,SILVEER
1	553075	2	EXTRUSION-AL,99.0,OMEGA STP,SILVER
1	553076	2	EXTRUSION-AL,105.0,OMEGA STP,SILVER
1	553077	2	EXTRUSION-AL,111.0,OMEGA STP,SILVER
1	553078	2	EXTRUSION-AL,122.0,OMEGA STP,SILVER
1	553062	2	EXTRUSION-AL,95.0,OMEGA STP,BLACK
1	553063	2	EXTRUSION-AL,99.0,OMEGA STP,BLACK
1	553065	2	EXTRUSION-AL,111.0,OMEGA STP,BLACK
1	553066	2	EXTRUSION-AL,122.0,OMEGA STP,BLACK
2	107957	6	ALUM,STP-PAD,BLK,OMEGA-STEP
3	107956	4	CAP-END,PLSTC,2.95 X 6.70
4	106880	28	SCREW-SQ HD,5/16-18 X 1,MAGNIGUARD
5	102680	28	NUT-SERR FLG,HX,SST,WX,5/16-18
6	107958	30	SCREW-PPH,TEK,#8-18 X 1/2",SST,BZP



## STEP PAD LOCATION GUIDE



VEHICLE MODEL	PAD A	PAD B
SILVERADO/SIERRA DOUBLE CAB	14-3/4	46-3/4
SILVERADO/SIERRA EXTENDED CAB	14-3/4	41-3/4
SILVERADO/SIERRA CREW CAB	14-3/4	54-1/4
CHEVROLET EXPRESS VAN & GMC SAVANA VAN	7-1/2	N/A
RAM QUAD CAB	10-1/2	46
RAM CREW CAB	10-1/2	48
RAM MEGA CAB	10-1/2	52-1/16
FORD F150 SUPER CAB	18-1/4	46-1/4
FORD F150 SUPER CREW CAB	18-1/4	56-1/2
FORD F150 SUPER CREW CAB	18-1/4	56-1/2
FORD SUPER DUTY SUPER CAB	6-7/8	39-1/16
FORD SUPER DUTY CREW CAB	6-7/8	52-7/8
FORD	7-1/2	N/A

**NOTE: THE ABOVE PAD LOCATIONS ARE ONLY SUGGESTIONS AND MAY BE PLACED AT THE PURCHASERS DISCRETION.**

## INSTALLATION INSTRUCTIONS AND PARTS LIST

APPLICATION: MODEL 571032/401032 SES/GRIP STEP BRACKETS ON:  
09-16 RAM CREW CAB, QUAD CAB, AND MEGA CAB PICKUPS



1. READ INSTRUCTIONS COMPLETELY AND CHECK TO MAKE SURE THAT ALL REQUIRED PARTS (LISTED ON SERVICE PARTS LIST) ARE ON HAND BEFORE STARTING THE INSTALLATION.
2. ASSEMBLE THE LOAD REACTION STUDS AND HARDWARE AS FOLLOWS.

**NOTE: USE A 4" STUD (ITEM #16) FOR THE FRONT BRACKET AND A 3" STUD (ITEM #15) FOR THE REAR BRACKETS. HEAVY DUTY PICKUPS WITH THE DIESEL ENGINE WILL NOT USE THE CENTER LOAD REACTION STUD.**

- 2.1. ON THE SHORT THREADED END OF THE LOAD REACTION STUD (ITEM #15, 16, 19), INSTALL A 3/8" SERRATED FLANGE NUT (ITEM #14) BACKWARDS TO THE BOTTTOM OF THE THREAD. THEN INSTALL A 3/8" FLAT WASHER (ITEM #13) AND RUBBER "CUSHION" WASHER (ITEM # 12) TIGHT UP AGAINST THE SERRATED FLANGE NUT. (THE END OF THE STUD MUST BE RECESSED IN THE RUBBER WASHER APPROX. 3/16").
  - 2.2. ON THE LONG THREADED END OF THE STUD, INSTALL A 3/8" SERRATED FLANGE NUT (ITEM # 14) BACKWARDS TO NEAR TO THE BOTTTOM OF THE THREADS
3. ATTACH THE LOAD REACTION STUD ASSEMBLIES TO THE MOUNTING BRACKETS AS SHOWN. INSERT THE STUD, FROM WHAT WILL BE THE INBOARD OR FRAME SIDE THRU THE LOWEST HOLE IN THE BENT FLANGE OF THE BRACKET THAT WILL ALLOW THE RUBBER WASHER TO SEAT FIRM AGAINST THE SIDE WALL OF THE FRAME. INSTALL A FLANGE NUT (ITEM #14) ON THE OUTBOARD END OF THE STUD (FINGER TIGHT ONLY).
  4. ON THE RIGHT SIDE OF THE VEHICLE, REMOVE THE FACTORY FRONT, CENTER, AND REAR BODY MOUNT BOLTS (ONE SIDE OF THE VEHICLE AT A TIME), THESE WILL NOT BE REUSED. INSTALL THE MOUNTING BRACKETS PER THE FOLLOWING INSTRUCTIONS:
    - 4.1. USING A M12 – 110MM BOLT (ITEM #9) AND A 2.0" WASHER (ITEM #11) INSTALL THE FRONT MOUNTING BRACKET (ITEM #1, 2) TO THE FRONT BODY MOUNT AS SHOWN (LEAVE THESE FASTENERS FINGER TIGHT).
    - 4.2. USING A M12 – 110MM BOLT (ITEM #9) AND A 2.0" WASHER (ITEM #11) INSTALL THE CENTER MOUNTING BRACKET (ITEM #3, 4) TO THE CENTER BODY MOUNT AS SHOWN (LEAVE THESE FASTENERS FINGER TIGHT).
    - 4.3. FOR 1500 PICKUPS, IF THERE IS A CAST IRON DAMPENER ON THE REAR BODY MOUNT PLEASE REMOVE (THIS WILL NOT BE REUSED).
    - 4.4. USING A M12 – 110MM BOLT (ITEM #9) (**NOTE: IF INSTALLING ON A HEAVY DUTY PICKUP USE A M12-160MM BOLT (ITEM #10)**) AND A 1/2" FLAT WASHER (ITEM #18) INSTALL THE REAR MOUNTING BRACKET (ITEM #5, 6) TO THE REAR BODY MOUNT AS SHOWN (LEAVE THESE FASTENERS FINGER TIGHT). **NOTE: THE ORIENTATION OF THE REAR BRACKET WILL BE DIFFERENT BETWEEN THE QUAD/CREW CAB PICKUPS AND THE MEGA CAB PICKUPS. IF INSTALLING ON A QUAD/CREW CAB PICKUP REFER TO FIG. 2, IF INSTALLING ON A MEGA CAB PICKUP REFER TO FIG. 3.**
    - 4.5. ATTACH THE REAR OUTBOARD MOUNTING BRACKET (ITEM #7, 8) TO THE REAR INBOARD MOUNTING BRACKET (ITEM #5, 6), USING THREE 3/8-16 X 1.0 SCREW, 3/8" FLAT WASHERS AND 3/8" FLANGE NUTS. (ITEMS #17, 13, 14). **NOTE: IF INSTALLING ON A LIGHT DUTY PICKUP INSTALL IN THE LOWER HOLE LOCATIONS, IF INSTALLING ON A HD PICKUP INSTALL IN THE UPPER HOLE LOCATIONS. (FIG. 1)**



(A LUCERNE Company)

1200 E. Birch St.

Brandon, SD 57005

552859 SHEET 1 OF 5 20APR15

5. ATTACH THE STEP PLATE PER THE INSTRUCTIONS INCLUDED WITH YOUR STEP PLATE ASSEMBLY.
6. POSITION THE LOAD REACTION STUD ASSY SO THAT THE RUBBER CUSHION IS SNUG UP AGAINST THE SIDE OF THE FRAME. TIGHTEN THE 3/8" FLANGE NUTS ON EITHER SIDE OF THE BRACKET TO 19LB. FT.

### SERVICE PARTS LIST

ITEM	PART NO.	QTY	DESCRIPTION
1	552850	1	BRKT-MTG, SES, FRONT, LH, BODY MOUNT
1	552862	1	BRKT-MTG, GRIP, FRONT, LH, BODY MOUNT
2	552851	1	BRKT-MTG, SES, FRONT, RH, BODY MOUNT
2	552863	1	BRKT-MTG, GRIP, FRONT, RH, BODY MOUNT
3	552852	1	BRKT-MTG, SES, CENTER, LH, BODY MOUNT
3	552864	1	BRKT-MTG, GRIP CENTER, LH, BODY MOUNT
4	552853	1	BRKT-MTG, SES, CENTER, RH, BODY MOUNT
4	552865	1	BRKT-MTG, GRIP, CENTER, RH, BODY MOUNT
5	552854	1	BRKT-MTG, REAR, LH, INBOARD, BODY MOUNT
6	552855	1	BRKT-MTG, REAR, RH, INBOARD, BODY MOUNT
7	552856	1	BRKT-MTG, SES, REAR, LH, OUTBOARD
7	552868	1	BRKT-MTG, GRIP, REAR, LH, OUTBOARD
8	552857	1	BRKT-MTG, SES, REAR, RH, OUTBOARD
8	552869	1	BRKT-MTG, GRIP, REAR, RH, OUTBOARD
9	103444	6	SCREW-HEX HEAD, M12 - 1.75 X 110MM, ZP
10	109451	2	SCREW-HEX HEAD, M12 - 1.75 X 160MM, BZP
11	105909	4	WSHR-FLAT, 2.0 X .509 X .179, ZP
12	102592	6	WSHR, RUBBER, .354 ID X 1.00 OD X .75 THK
13	100062	12	WSHR, FLAT, 3/8", .438 ID X 1.00 OD X .083" THK
14	100181	24	NUT, SERR FLG, HEX, 3/8-16 UNC, ZP
15	104697	4	STUD, STL, 3/8-16 X 3.00", ZP
16	104686	2	STUD, -DBL ENDED, STL, 3/8-16 X 4.00", ZP
17	100040	6	SCR-HEX HD, 3/8-16 X 1.0" UNC, ZP
18	100118	2	WASHER, FLAT, 1/2" ZP



1200 E. Birch St.

Brandon, SD 57005

# FIG. 1 REAR BRACKET ASSEMBLIES

SERVICE PARTS LIST

MODEL NO. -571032/401032

1500 QUAD/CREW CABS

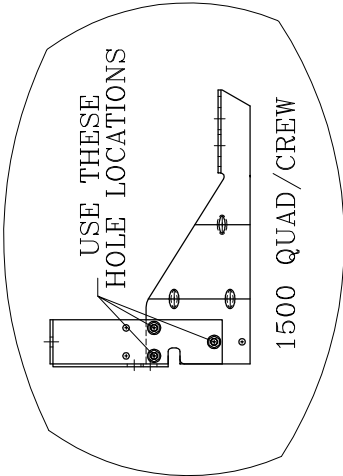
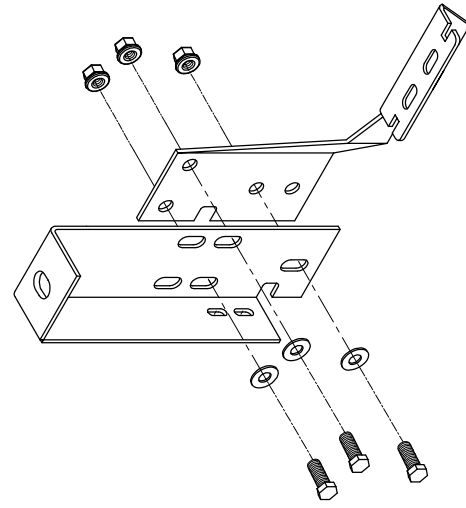

HD CREW CABS

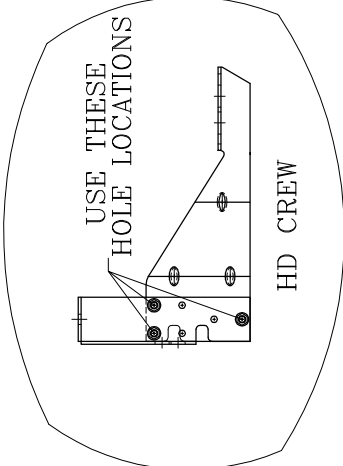
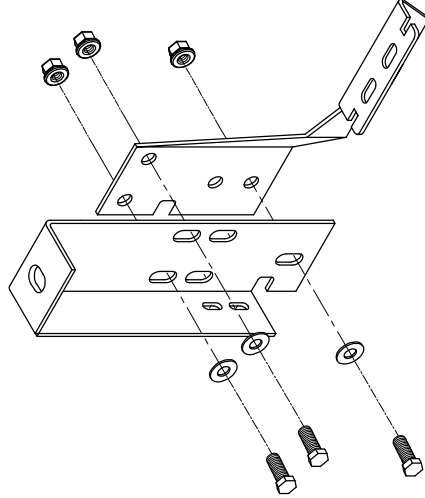

HD MEGA CABS

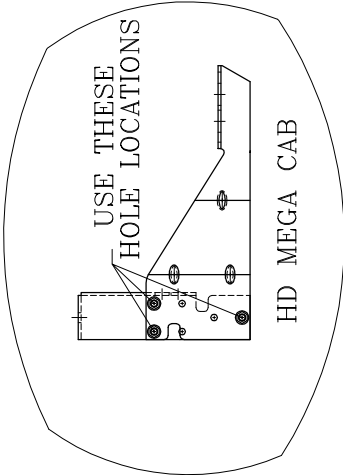
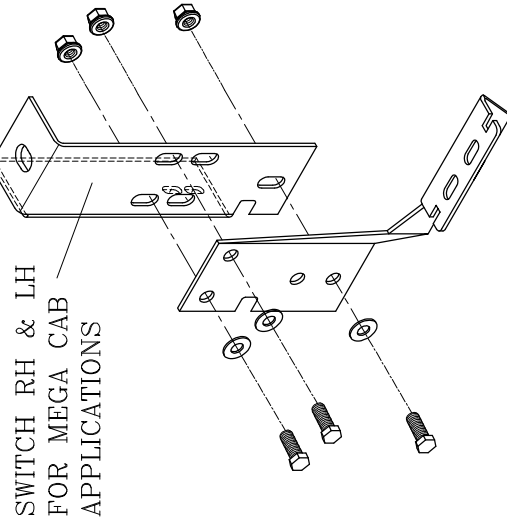

LEFT (DRIVER) SIDE SHOWN  
-RIGHT (PASSENGER) SIDE OPPOSITE-

# FIG. 2 CREW / QUAD CAB

SERVICE PARTS LIST

MODEL NO. -571032/401032

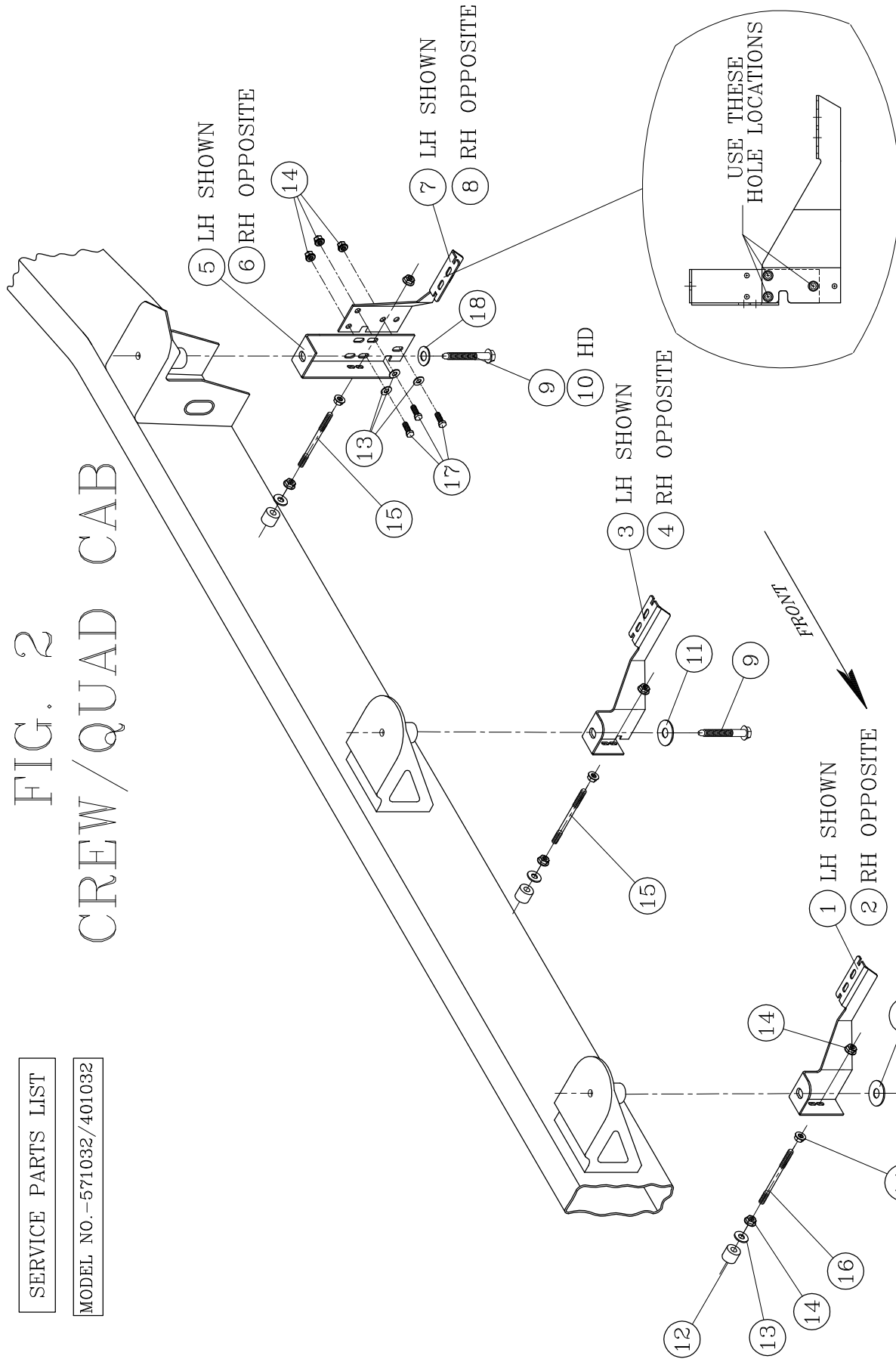

LEFT (DRIVER) SIDE SHOWN

LEFT (DRIVER) SIDE SHOWN  
-RIGHT (PASSENGER) SIDE OPPOSITE-

**LOVERNE**  
A LUMBER COMPANY  
1200 E. Main St.  
Burlington, VT 05403

SERVICE PARTS LIST

MODEL NO. -571032/401032

# FIG. 3 MEGA CAB PICKUPS

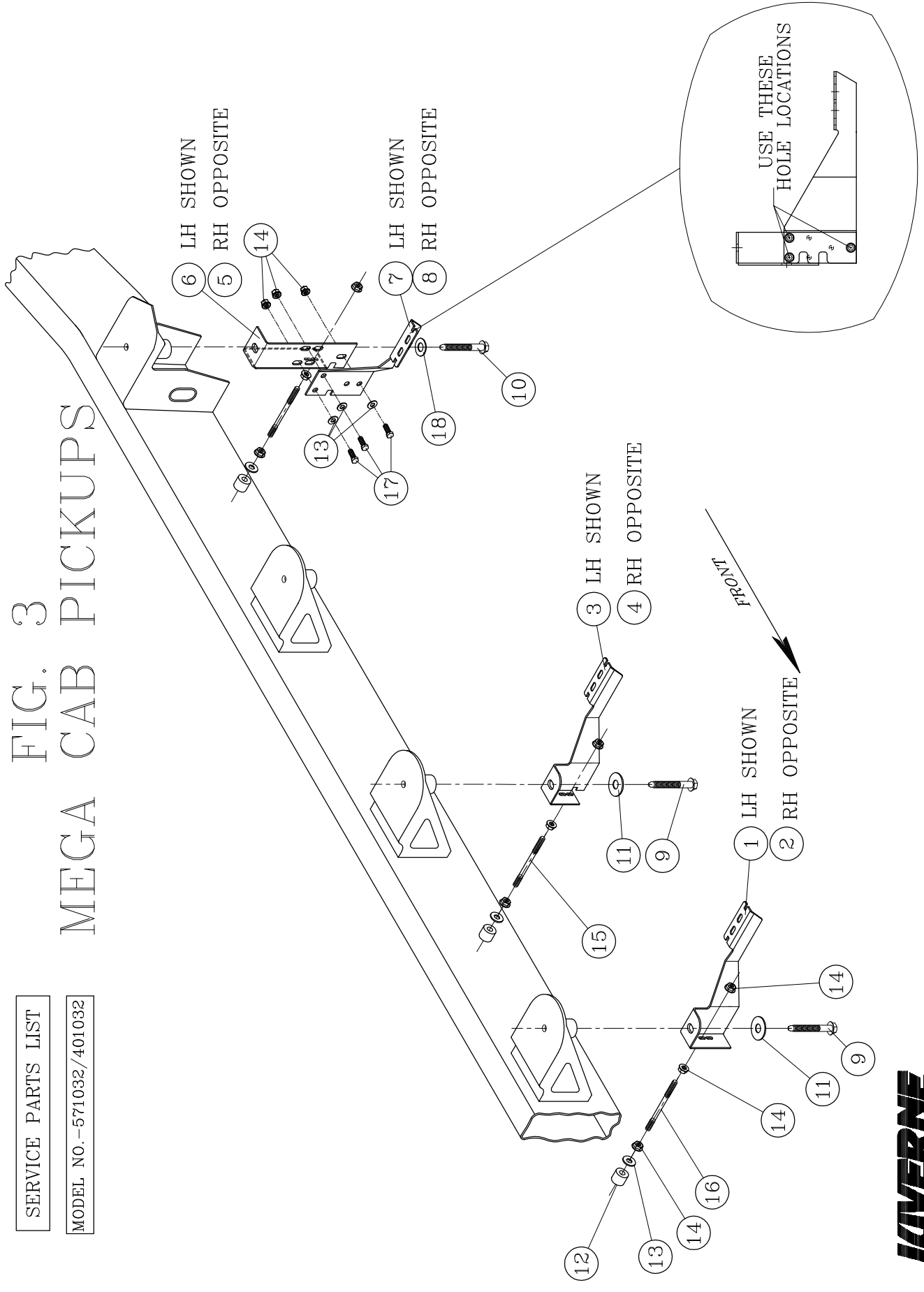

LEFT (DRIVER) SIDE SHOWN  
-RIGHT (PASSENGER) SIDE OPPOSITE-

