

WeatherTech®

Easy-On™ Stone & Bug Deflectors

Important Safety Information



- CAUTION - Before driving, ensure that the hood shield is properly secured to vehicle.
- Do not use automatic "brush-style" car washes.
- Do not use cleaning solvents of any kind.
- Periodically check all components for tightness.

Contents **NOTE:** Actual product may vary from illustration.

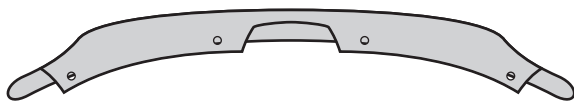

Hood Shield

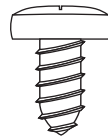

Phillips Screw x4

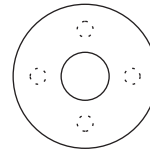

Plastic Washer x4



Bump On x4

Tools Required



Car Wash Supplies



Clean Towel

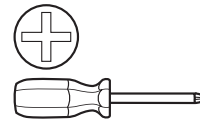

Phillips Screwdriver

Preparation Before Painting / Installation

- A trial fit is recommended to ensure proper positioning and fit.
- Check fit of parts before painting as we will not accept the return of modified or painted parts.
- Wash and dry your vehicle to remove any debris and/or dirt from the installation area.

Installation Steps **NOTE:** Actual application may vary slightly from illustrations.

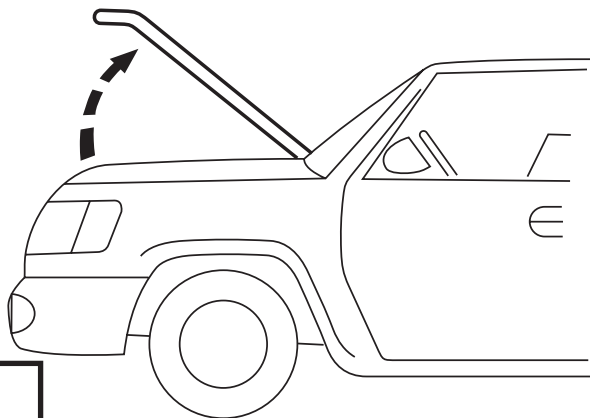

1

Align Hood Shield with holes in hood.

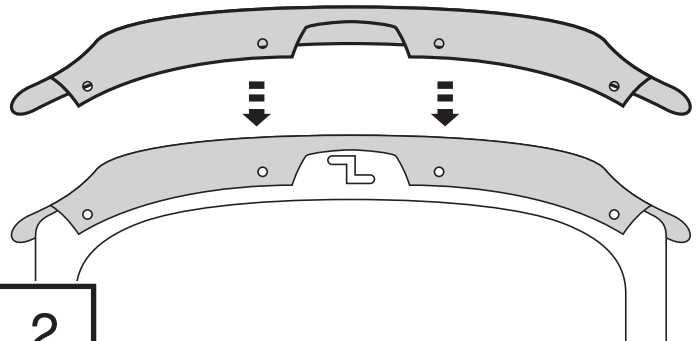

2

Installation Steps

NOTE: Actual application may vary slightly from drawings.

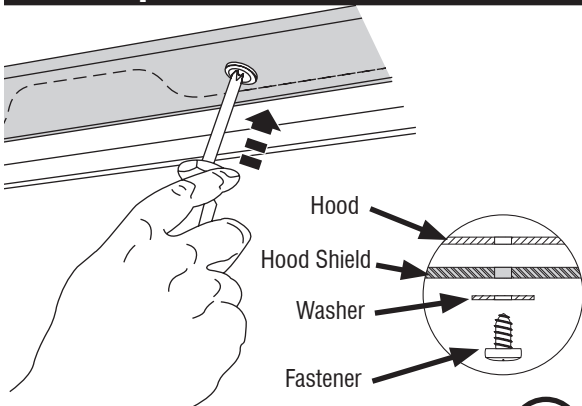
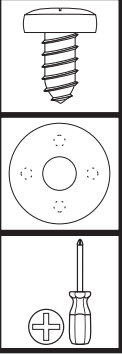

3

Do not overtighten

X4

4

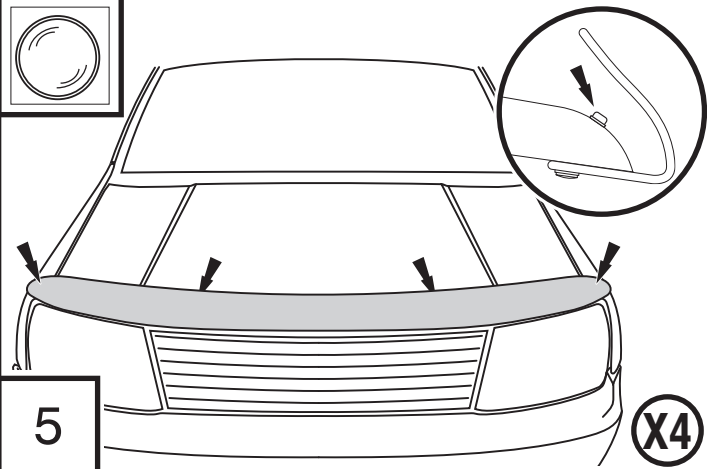
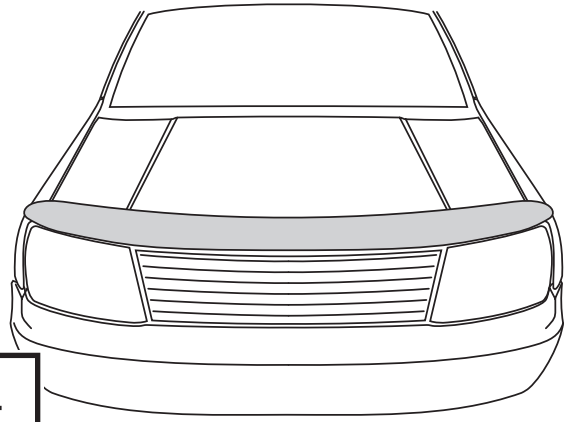

5

X4

Care and Cleaning

- Wash only with mild soap & dry with a clean cloth.



1 MacNeil Ct.

Bolingbrook, IL 60515

Questions? Call customer service @ 630.769.1500

Monday - Friday, 9 a.m. to 5 p.m. Central Time

www.WeatherTech.com

WeatherTech®

Easy-On™ Stone & Bug Deflectors

Informations importantes concernant la sécurité



- ATTENTION – Avant de conduire, s'assurer que le pare-insectes est solidement assujettie sur le véhicule.
- Ne pas utiliser les stations de lavage de voitures à brosse.
- Ne pas utiliser de solvants.
- Vérifier régulièrement le serrage des composants.

Contenu **NOTE:** Le produit réel peut changer de l'illustration.

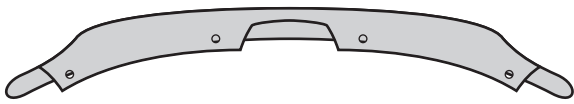

Pare-insectes

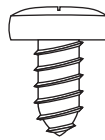

Vis Phillips
(4)

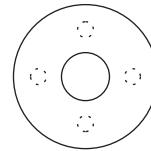

Rondelle En plastique
(4)



Butoirs (4)

Outils nécessaires



Fournitures pour lavage de
voiture

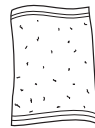

Serviette propre

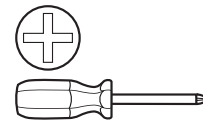

Tournevis Phillips

Préparation pour la peinture/l'installation

- Il est recommandé de procéder à un essai pour s'assurer que le positionnement et l'ajustement sont corrects.
- Vérifier l'ajustement des pièces avant peinture, car nous n'acceptons pas le retour de pièces modifiées ou peintes.
- Laver les glissières de glaces de la portière du véhicule pour éliminer toute poussière et tous débris.
- Sécher les glissières avec une serviette propre.

Étapes d'installation

REMARQUE : La méthode d'application peut être légèrement différente de celle représentée par les illustrations.

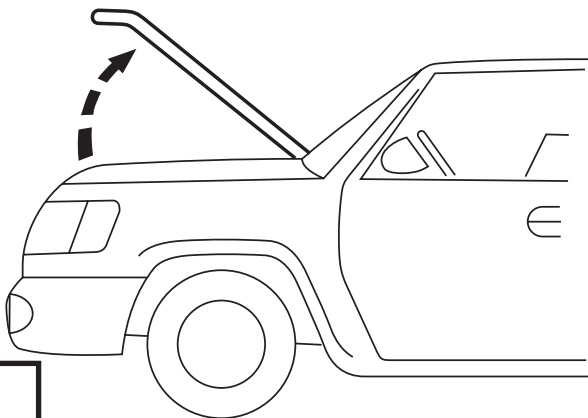

1

Alignez Pare-insectes
avec des trous dans le capot.

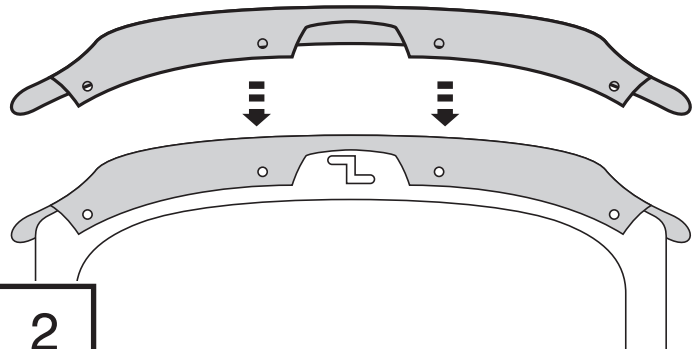

2

Étapes d'installation

REMARQUE : La méthode d'application peut être légèrement différente de celle représentée par les illustrations.

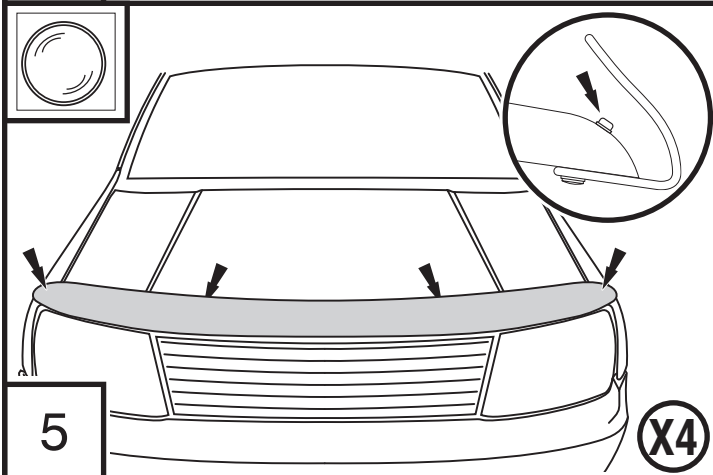
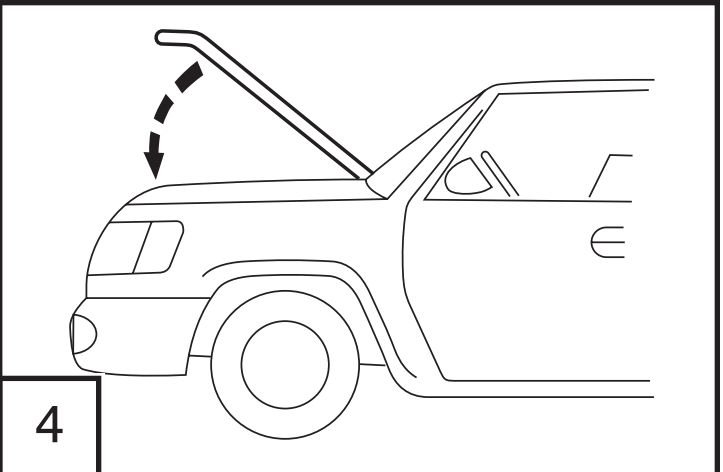
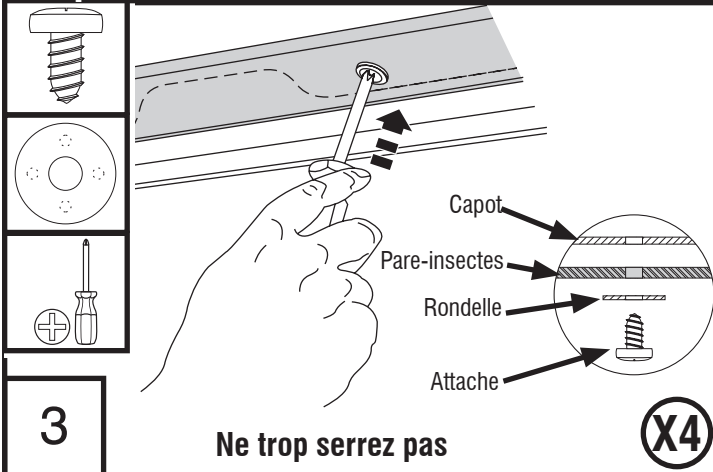

Entretien et nettoyage

- Laver exclusivement avec de l'eau savonneuse et sécher avec un chiffon propre.



1 MacNeil Ct.
Bolingbrook, IL 60515
Questions? Call customer service @ 630.769.1500
Monday - Friday, 9 a.m. to 5 p.m. Central Time
www.WeatherTech.com

WeatherTech®

Easy-On™ Stone & Bug Deflectors

Información importante de seguridad



- PRECAUCIÓN - Antes de conducir, asegúrese de que la visera deflectora esté correctamente anclada al vehículo.
- No utilice servicios automáticos de limpieza de vehículos que utilizan cepillos.
- No utilice limpiadores al solvente de ningún tipo.
- Compruebe periódicamente que todos los componentes estén ajustados.

Contenido **NOTA:** El producto real puede variar de la ilustración.

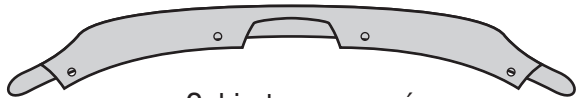

Cubierta para capó

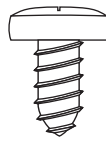

Tornillo Phillips (4)

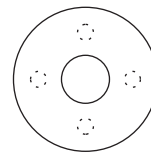

Arandela Plástica (4)



Soporte x4

Herramientas necesarias



Equipo de limpieza de vehículos

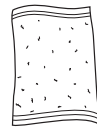

Toalla limpia

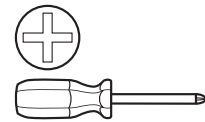

Destornillador Phillips

Preparación antes de pintar o instalar

- Se recomienda realizar un ajuste de prueba para asegurar el posicionamiento y ajuste correctos.
- Compruebe que las piezas se ajusten correctamente antes de pintarlas, ya que no aceptaremos la devolución de piezas modificadas o pintadas.
- Lave los canales de la ventanilla del vehículo para quitar los desechos y la suciedad.
- Seque los canales de la ventanilla con una toalla limpia.

Pasos de instalación **NOTA:** El uso real puede variar levemente de ilustraciones.

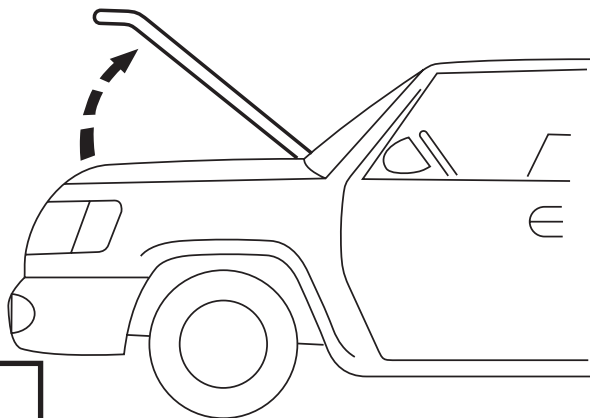

1

Alinee Cubierta para capó con los agujeros en capilla.

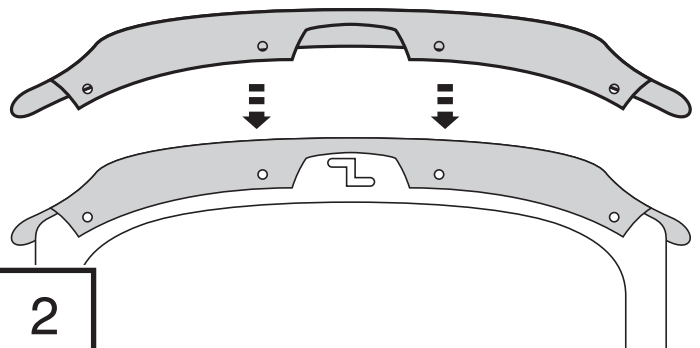

2

Pasos de instalación

NOTA: El uso real puede variar levemente de ilustraciones.

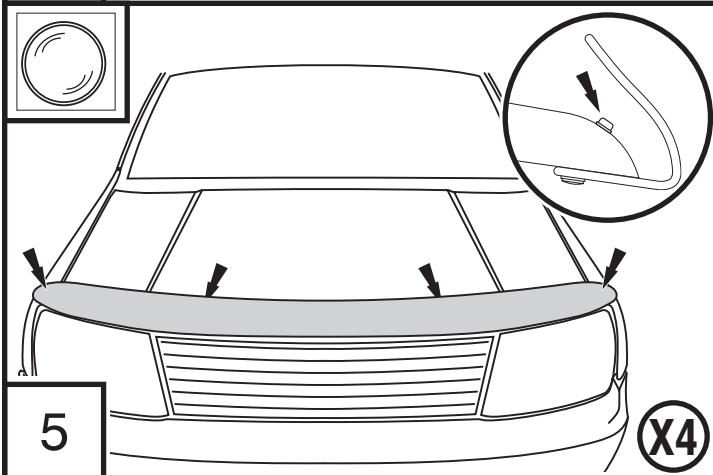
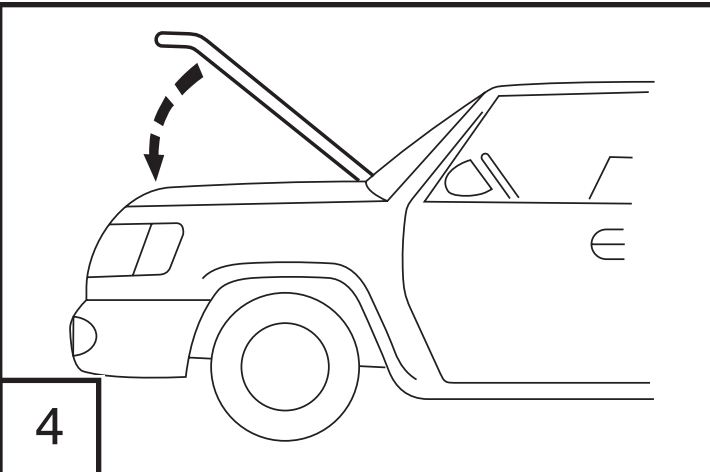
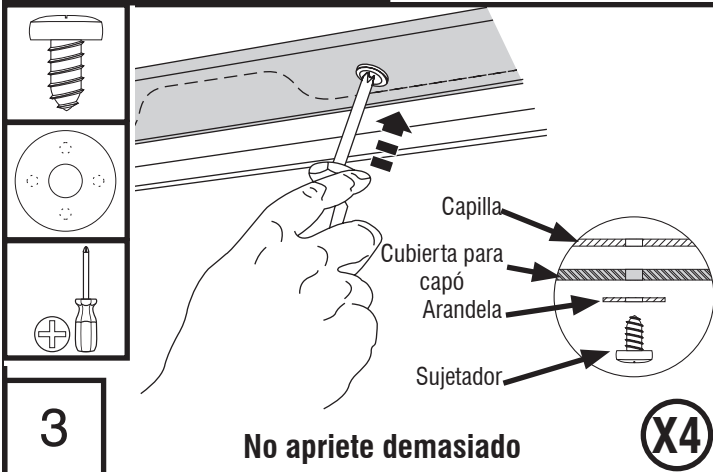

Cuidado y limpieza

- Limpie solamente con agua jabonosa tibia y seque con un paño limpio.



1 MacNeil Ct.

Bolingbrook, IL 60515

Questions? Call customer service @ 630.769.1500

Monday - Friday, 9 a.m. to 5 p.m. Central Time

www.WeatherTech.com