

MSD INSTALLATION INSTRUCTIONS

Atomic EFI Return System PN 2922

ONLINE PRODUCT REGISTRATION: Register your MSD product online. Registering your product will help if there is ever a warranty issue with your product and helps the MSD R&D team create new products that you ask for! Go to www.msperformance.com/registration.

Thank you for selecting the Atomic Fuel Line Return kit. This kit is recommended for use with the Atomic Throttle Body EFI and Atomic LS EFI systems.

Parts Included:

- | | |
|--------------------------------------|--|
| 1 - Adjustable Regulator | 1 - Regulator Parts Bag includes: |
| 1 - -6AN Port Plug | 1 - Regulator Mounting Bracket |
| 3 - -6AN Straight Port Fittings | 1 - Brass Hose Barb Fitting |
| 2 - -6AN 90° Push-Lock Fittings | 1 - Stainless Steel Pipe Plug |
| 2 - -6AN Straight Push-Lock Fittings | 2 - 10-32 x 0.375 Button Head Cap Screws |
| 15 Feet - High Pressure Fuel Hose | 1 - High Pressure Fuel Hose Clamp |

CAPABILITIES

The Atomic Adjustable Regulator is configured for a single -6AN inlet, and dual -6AN outlets (for regulator-to-tank line routing flexibility). The recommended operating range is 0-90 psig (pounds per square inch gauge). The maximum recommended flow rate is 500 liters/hour (2.2 GPM). The vacuum/boost compensation ratio is 1:1.

RECOMMENDED PLUMBING SCHEMATICS

Use the schematic below as a guide when installing the kit in conjunction with an Atomic throttle body EFI system. There are two possible connection points on the throttle body unit, one of which will be the fuel supply in an operational system. DO NOT "tee" into the supply line and leave the -6AN port plug installed in the remaining throttle body port. Remove the -6AN port plug from the throttle body and route fuel from that port to the regulator inlet port (using the supplied hose and fittings). The hose length between the throttle body and regulator is not critical, but generally speaking, should be kept to a minimum. Route and secure the hose as necessary to prevent chafing, stretching due to engine movement, and heat-related damage.

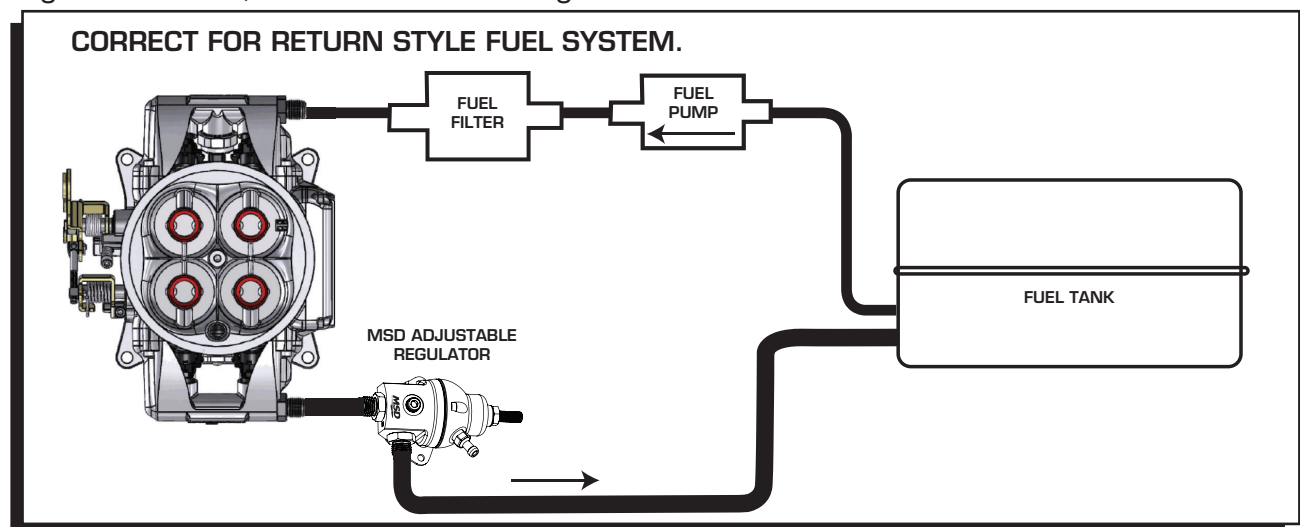

Figure 1 Atomic TBI Return Fuel System.

Use the schematic below as a guide when installing the kit in conjunction with an Atomic LS EFI system. There are two possible connection points (one at the rear of each fuel rail assembly). One rail will be connected to the fuel supply in an operational system. DO NOT "tee" into the supply line and leave the opposing fuel rail plugged or capped. Fuel from the opposing rail should be routed to the regulator inlet port (using the supplied hose and fittings). The hose length between the rail and regulator is not critical, but generally speaking, should be kept to a minimum. Route and secure the hose as necessary to prevent chafing, stretching due to engine movement, and heat-related damage.

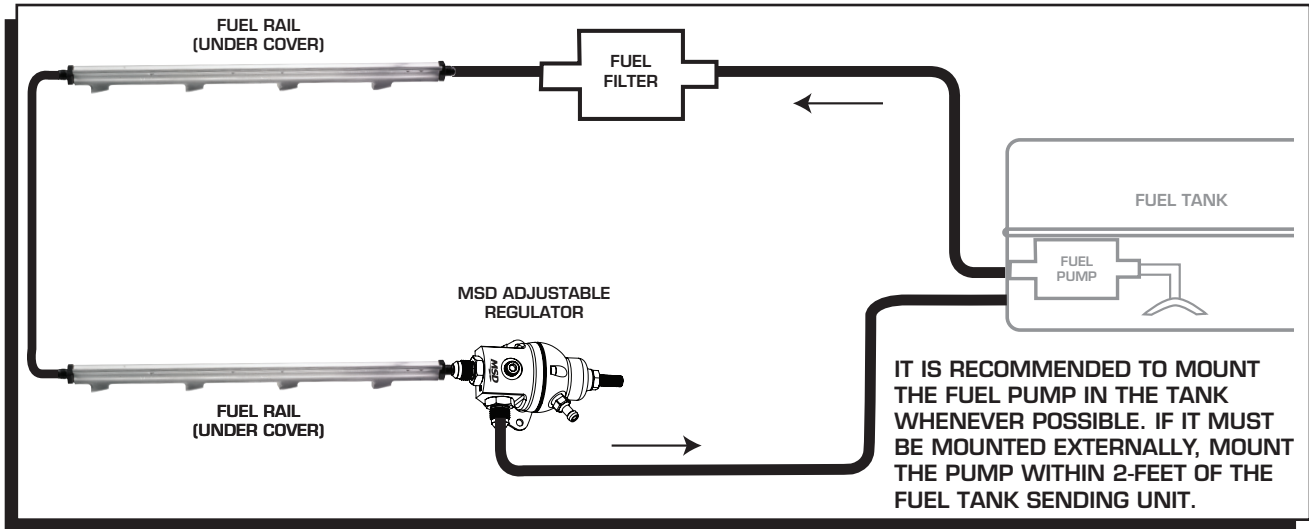

Figure 2 Atomic LS Return Fuel System.

The regulator-to-tank connection should be made using the supplied hose and fittings. Install the supplied -6AN port plug in whichever regulator return port is not used. Depending on the configuration of your fuel tank / fuel cell, the supplied high pressure fuel hose clamp may be used at the tank fitting connection.

Use care when routing the hose from the regulator to the tank. Route and secure the hose as necessary to prevent chafing, stretching due to engine movement, and heat-related damage.

REGULATOR MOUNTING

Using the two (2) supplied 10-32 x 0.375 Button Head Cap Screws and a 1/8-inch hex key (Allen wrench), attach the regulator bracket to the regulator body. The regulator may then be mounted to the firewall, or other convenient surface. Regulator orientation is not critical, but be mindful of adjustment screw access and hose routing. Refer to Figure 3 for a mounting bracket template.

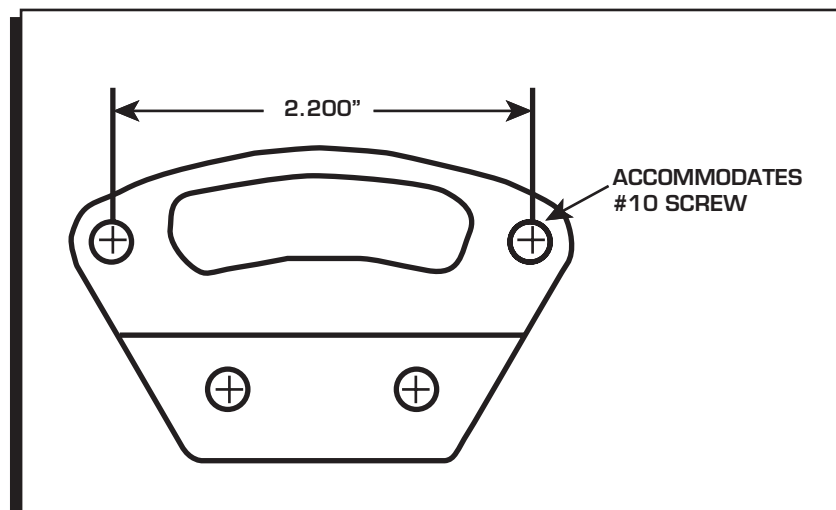

Figure 3 Regulator Mounting Bracket Template

REGULATOR CONNECTIONS AND ADJUSTMENT

The regulator inlet port is located on the bottom surface, and clearly marked with an identifier machined in the housing (see Figure 4 below). Two (2) outlet ports are available, but typically only one (1) will be used. Install the supplied -6AN port plug in the unused outlet port using a 5/16-inch hex key (Allen wrench). The -6AN straight port fittings should be snugged with an 11/16-inch wrench or deep socket.

Install the supplied 1/8-27 NPT brass hose barb fitting in the upper regulator housing (see Figure 4 below) using a 7/16-inch wrench or deep socket. Thread sealer is not required on this fitting, but can be used if desired. Connect an intake manifold vacuum / boost source to this fitting, or leave it open to the atmosphere if manifold pressure compensation is not required. **DO NOT** plug this opening. Ensure that contaminants (such as water and road spray) cannot enter the open fitting. In the event that vacuum / boost reference is not required, a more cosmetically pleasing option is to install a sintered metal exhaust muffler in this port (such as McMaster-Carr PN 4450K1-Bronze or PN 4402K51-Stainless Steel)

The 1/8-27 NPT port in the lower housing allows the installation of a fuel pressure gauge (direct or remote-reading). If use of this port is not required, install the supplied stainless steel pipe plug using a 3/16-inch hex key (Allen wrench). Use of a fuel compatible paste-type thread sealer is **REQUIRED** on this plug. Thread sealing tape is also an option, but not recommended due to the potential for particulate and debris generation.

Use a 5/32-inch hex key (Allen wrench) to adjust the regulator set point. Clockwise rotation (screw advancing inward) increases the set point, and counter-clockwise rotation (screw advancing outward) decreases the set point. When the desired set point has been reached, snug the jam nut using a 1/2-inch wrench.

Refer to the user installation instructions, supplied with the Atomic EFI kit, for regulator set point recommendations.

Note: An overly lengthy and restrictive return line routing scheme may result in a non-negligible pressure rise across the regulator-to-tank portion of the system. For this reason, the final regulator adjustment should be made while monitoring the system fuel pressure (on the Atomic hand-held Dash) with the engine at idle.

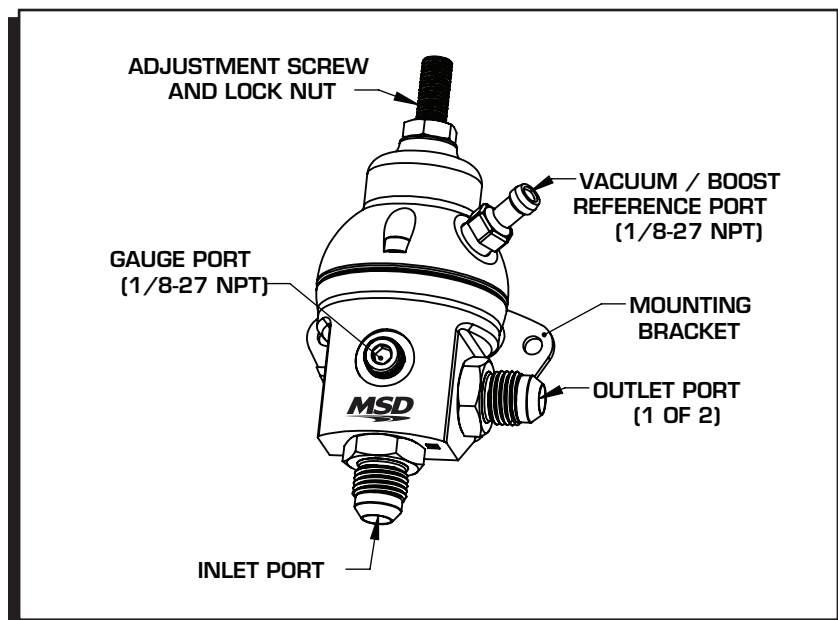

Figure 4 - Regulator Feature Identification Guide

STOP HERE

REVIEW YOUR INSTALLATION

Take a few extra minutes to check all aspects of your return fuel system installation at this point. Cycle the key on and off several times to ensure a complete fuel system prime, and verify that all connections and fittings are leak-tight. Don't forget to make the final regulator adjustment with the engine idling.

REGULATOR SERVICE

The regulator diaphragm assembly is available as a service kit from MSD and considered a user-serviceable item. Detailed instructions are available in the service kit, but for completeness, the following guidelines must be observed if it is necessary to separate the regulator housings.

- Use a 9/64-inch hex key (Allen wrench) to remove the three (3) 8-32 x 0.375 Socket Head Cap Screws
- Use care not to lose any internal parts (particularly the 1/4-inch ball beneath the adjustment screw)
- Upon re-assembly, ensure that no debris or particulates are trapped between the housing mating surfaces (these may cut or damage the diaphragm)
- Align the diaphragm slots with the three (3) screw holes and stack the spring assembly prior to installing the upper housing
- Install the three (3) 8-32 x 0.375 SHCS to a staged final torque of 25-28* in-lb.
 - o Stage 1 Torque: 10 in-lb
 - o Stage 2 Torque: 20 in-lb
 - o Stage 3 (final) Torque: 25-28* in-lb.

* Verify the Stage 3 torque after at least one hour has elapsed (to allow for diaphragm compression set)

Completing the installation of your MSD Atomic fuel return kit will require that several connections be made using the supplied high-pressure hose and push-lock fittings. Use compressed air (or equivalent) to ensure that all complete hose / fitting assemblies are clean prior to final installation.

To ensure that your connections are safe, durable, and cosmetically pleasing, we recommend that you adhere to the guidelines in the following section:

PROPER INSTALLATION OF PUSH-LOCK AN FITTINGS IN AEROQUIP AQP HOSE

Proper installation of push-lock fittings BEGINS with the first cut of the hose. The hose end must be cut squarely and cleanly. If these two requirements are not met, the connection is compromised from the start. See Figure 5 and 6 for additional information on achieving a proper cut.

Apply a light coating of fresh motor oil to the fitting barbs. More is NOT better – too much oil results in a slippery mess which makes it impossible to get a tight grip on the hose.

To the extent possible, make sure the push-lok fitting is well anchored – whether it is in a vise, connected to another stationary fitting, or against a hard surface. You WILL NOT get good results by trying to hold the fitting in one hand, and the hose in the other. Likewise, you WILL NOT get good results if you cannot apply sufficient force to fully engage the fitting barbs in one smooth motion. Having to stop and twist, and then resume pushing, typically results in an inferior connection - requiring that you cut the hose off the fitting and start again. This means that you should not try to push the hose on the fitting when leaning over the engine while standing on an old milk crate.

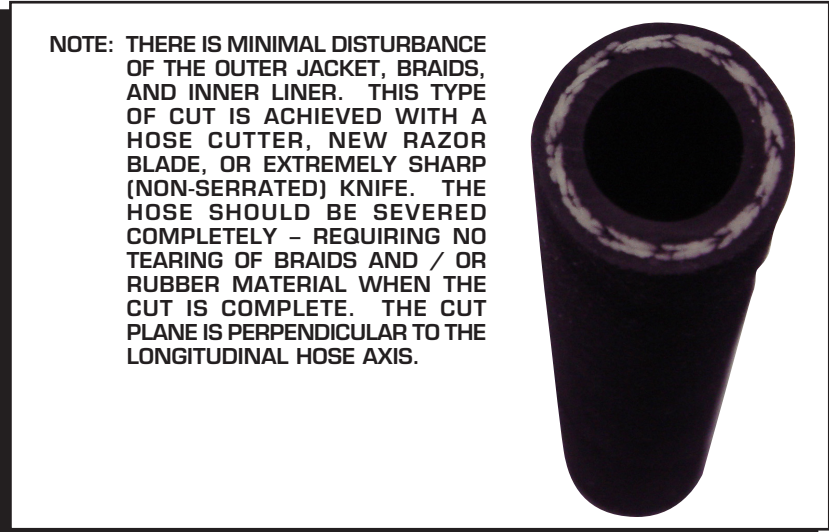

Figure 5 Correct Clean, Square Cut

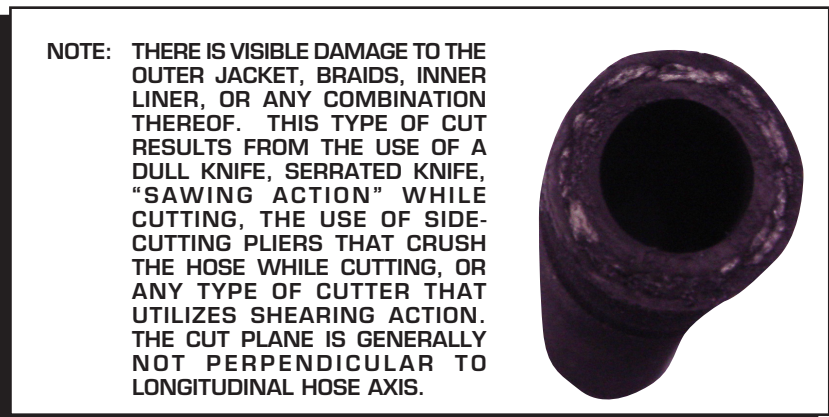

Figure 6 Incorrect Jagged, Rough Cut

The depth to which the fitting is inserted into the hose is **EXTREMELY IMPORTANT**. Stopping too soon, with the end of the hose positioned directly above the inboard hose barb, will result in excessive hoop stresses in the braids and outer jacket. Pushing too far, such that the hose starts to ride up on the beauty ring lead-in chamfer, will have the same result. In either case, the residual hoop stresses (in the braids and outer jacket) will lead to the formation of splits in the outer jacket once the hose has been exposed to under-hood temperatures. See Figure 7 for an example of an improperly installed fitting. See Figure 8 for an example of an improperly installed fitting – which resulted in splits in the outer hose jacket following heat exposure.

Use the thin edge of the beauty ring as a depth gauge for the end of the hose. **STOP** pushing when the end of the hose is flush with the thin edge of the beauty ring. At this point, the end of the hose should have “rolled over” the inboard barb and conformed snugly to the fitting neck. See Figure 9 for an example of a properly installed fitting.

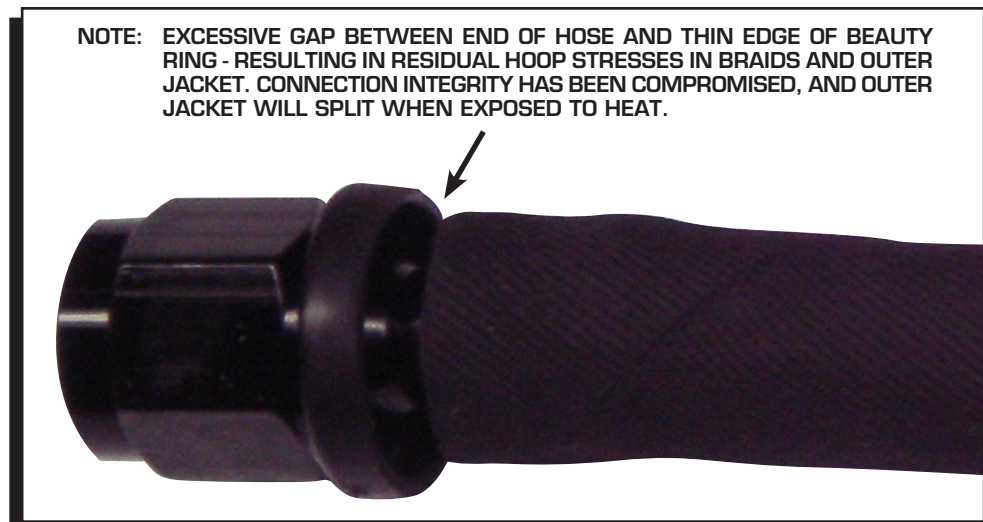

Figure 7 Improperly Installing Push-Lock Fitting



Figure 8 Improperly Installed Push-Lock Fitting

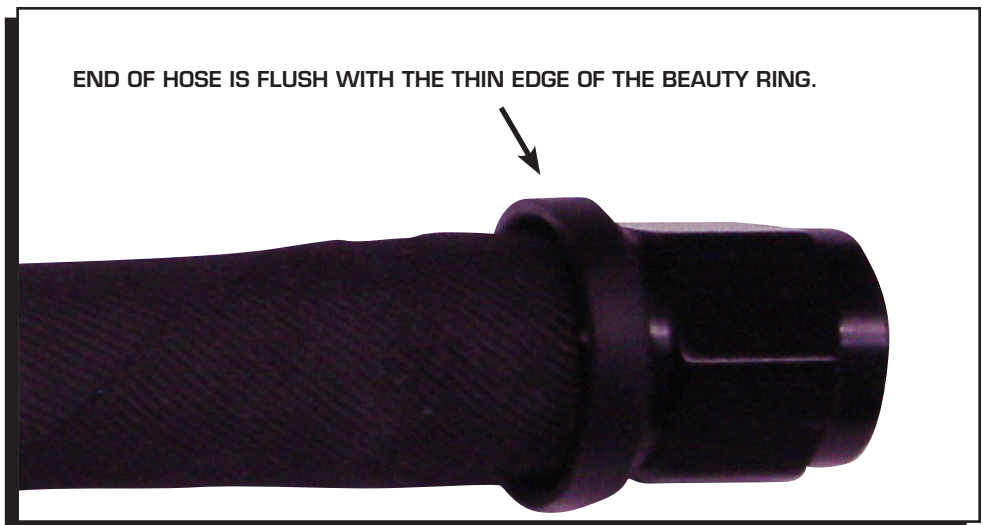

Figure 9 Properly Installed Push-Lock Fitting

