

Installation Instructions

07-18 Jeep Wrangler JK



VS18RPG
Part Number
78918

Ventshade® Deflector

**For proper installation and best possible fit, please read all instructions BEFORE you begin.
For technical assistance or to obtain missing parts, please call Customer Relations at 1-800-328-2409.**

Important Safety Information



- CAUTION - Before driving, ensure that the vent visor is properly secured to vehicle.
- Do not use automatic "brush-style" car washes.
- Do not use cleaning solvents of any kind.
- Periodically check all components for tightness.

Contents - 2 Piece Set



Front Driver
Side Visor



Front Passenger
Side Visor

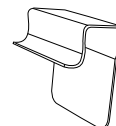

Retaining Clips x8

Contents - 4 Piece Set



Front Driver
Side Visor



Front Passenger
Side Visor



Rear Driver's
Visor

Rear Passenger's
Visor

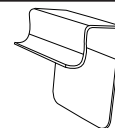

Retaining Clips
x14

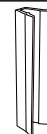

Spacer Clips
x2

Tools Required



Car Wash Supplies

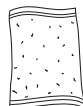

Clean Towel



Putty Knife

Preparation Before Painting / Installation

- A trial fit is recommended to ensure proper positioning and fit.
- Check fit of parts before painting as we will not accept the return of modified or painted parts.
- Wash and dry your vehicle to remove any debris and/or dirt from the installation area.

Installation Steps **NOTE:** Actual application may vary slightly from illustrations.

Lower passenger side window. Grasp and pull down the rubber window weatherstrip from the window channel.

rubber window channel

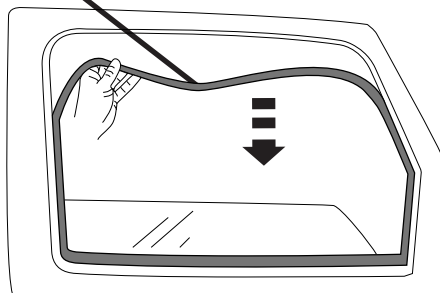

1

Installation Steps

NOTE: Actual application may vary slightly from illustrations.



Beginning at the front, insert a retaining clip into the underside of the weatherstrip. **NOTE:** The retaining clip will slip **inside** the pouch-like area located on the underside of the weatherstrip.

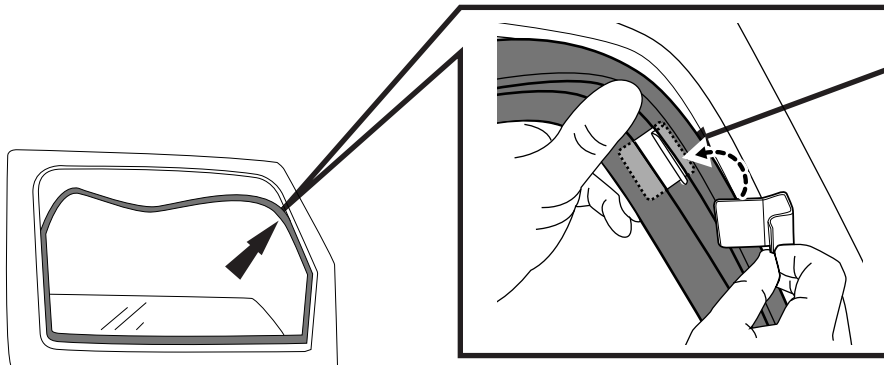

retaining clip in place

2



Repeat **Step 2** and insert three (3) more retaining clips into the weatherstrip.

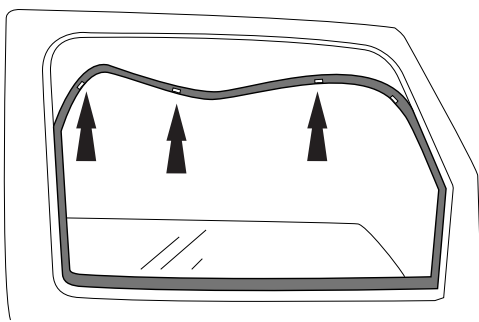

3

Realign the weatherstrip with the window channel. **NOTE:** Do NOT fully reseal the weatherstrip at this time.

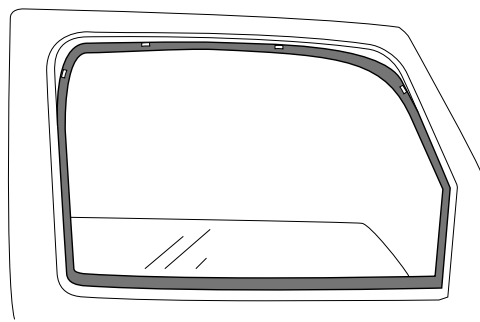

4



Beginning at the front, insert the visor into the clip. Use a putty knife to press the visor, retaining clip, and weatherstrip back into the window channel.

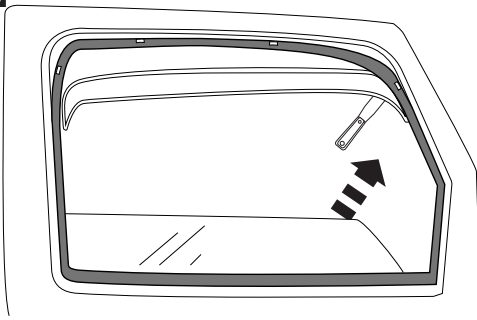

5

Repeat **Step 5** at remaining clip locations to finish front visor installation.

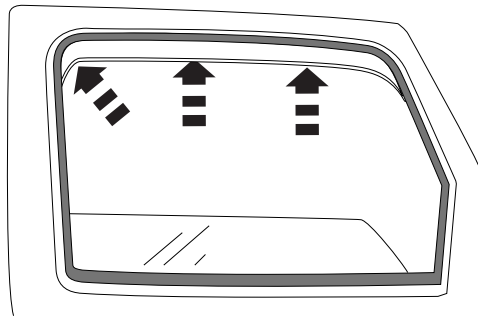

6

Rear door installation

Repeat **Steps 1 thru 6** at the three (3) locations indicated below. **NOTE:** the rear flange is inserted into the post window channel, and does **not** use a retaining clip.



Rear flange inserted into the post window channel

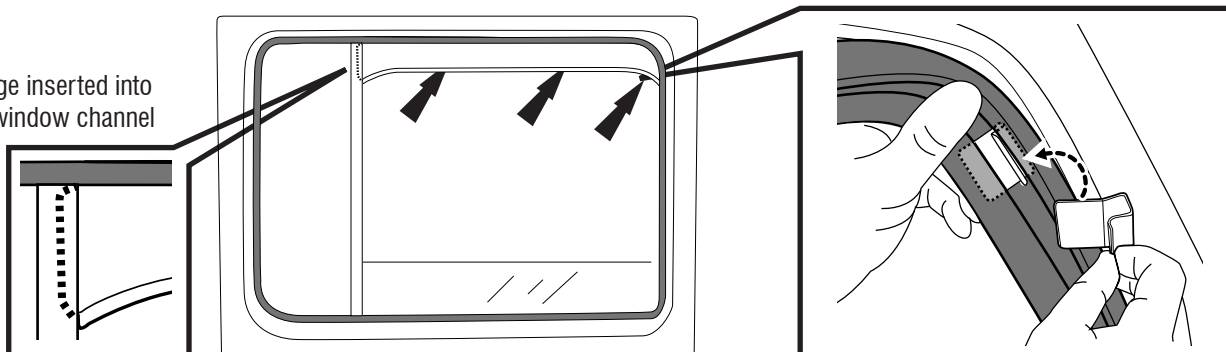

7

Installation Steps

NOTE: Actual application may vary slightly from illustrations.

At the rear flange location indicated below, use a putty knife to insert a spacer clip into the window channel to secure rear flange in place.



8

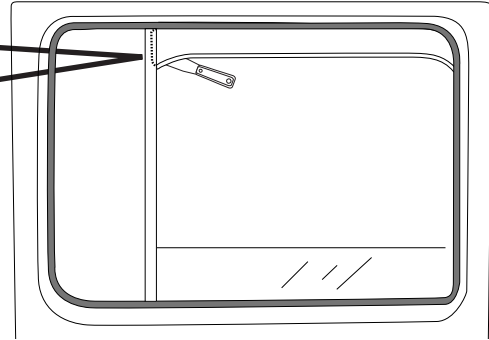
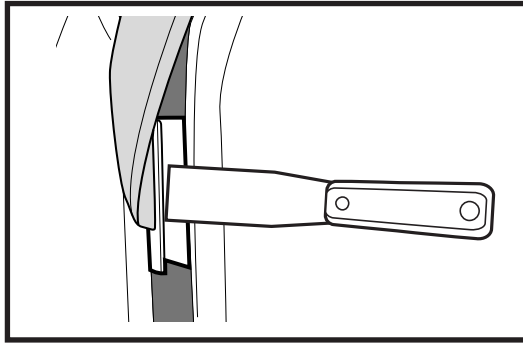

Repeat **Steps 1-8** for remaining windows

Care and Cleaning

- Wash only with mild soap & dry with a clean cloth.

Congratulations!

You have purchased one of the many quality Lund™ branded products offered by Lund International, Inc. We take the utmost pride in our products and want you to enjoy years of satisfaction from your investment. We have made every effort to ensure that your product is top quality in terms of fit, durability, finish and ease of installation.



Lund International

800-328-2409 • Visit us at lundinternational.com

© 2015 Lund International, Inc. All rights reserved.

Lund® and the Lund® logo are trademarks of Lund International, Inc.



Instructions d'installation

07-18 Jeep Wrangler JK



VS18RPG
Part Number
78918

Ventshade® Deflector

Pour obtenir une installation correcte et le meilleur ajustement possible, lire toutes les instructions **AVANT** de commencer.
Pour toute assistance technique ou obtention de pièces manquantes, appeler le service des relations avec la clientèle au
1-800-328-2409.

Informations importantes concernant la sécurité



- **ATTENTION** – Avant de conduire, s'assurer que la visière est solidement assujettie sur le véhicule.
- Ne pas utiliser les stations de lavage de voitures à brosses.
- Ne pas utiliser de solvants.
- Vérifier régulièrement le serrage des composants.

Contenu - Jeu de 2 pièces



Pare-soleil latéral
avant côté conducteur



Pare-soleil latéral
avant côté passager

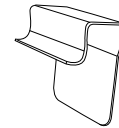

Attaches de retenue x 8

Contenu - Jeu de 4 pièces



Pare-soleil latéral
avant côté conducteur



Pare-soleil latéral
avant côté passager

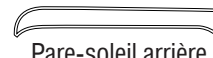

Pare-soleil arrière
côté conducteur



Pare-soleil arrière
côté passager

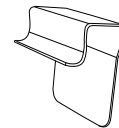

Attaches de
retenue x 14



Attaches
d'entretoise x 2

Outils nécessaires



Équipement de nettoyage



Linge propre



Couteau à mastic

Préparation avant la peinture/installation

- Effectuez d'abord un essai afin de vous assurer que le produit s'adapte à votre véhicule.
- Vérifiez que les pièces peuvent être correctement mises en place avant de peindre car nous n'acceptons pas le retour de pièces modifiées ou peintes.
- Nettoyez et séchez votre véhicule afin d'éliminer les débris et/ou les saletés de la zone d'installation.

Étapes de l'installation

REMARQUE : l'installation réelle peut différer légèrement des illustrations.

Abaissez la glace côté passager. Saisissez et retirez le caoutchouc d'étanchéité de la glace du canal de la glace.

canal de la glace en
caoutchouc

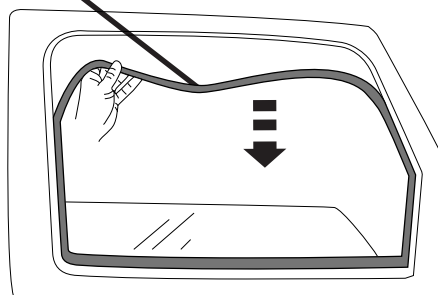

1

Étapes d'installation

REMARQUE : La méthode d'application peut être légèrement différente de celle représentée par les illustrations.



En commençant à l'avant, insérez une attache de retenue sous le caoutchouc d'étanchéité. **REMARQUE :** l'attache de retenue glissera à l'intérieur de la zone en forme de sac située sous le caoutchouc d'étanchéité.

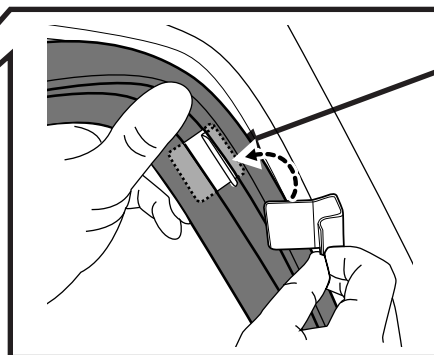
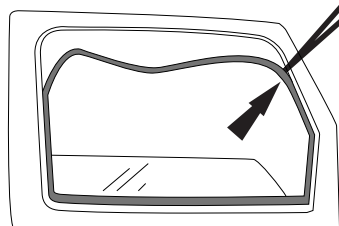

attache de retenue en place

2



Répétez l'étape 2 et insérez trois (3) attaches de retenue supplémentaires dans le caoutchouc d'étanchéité.

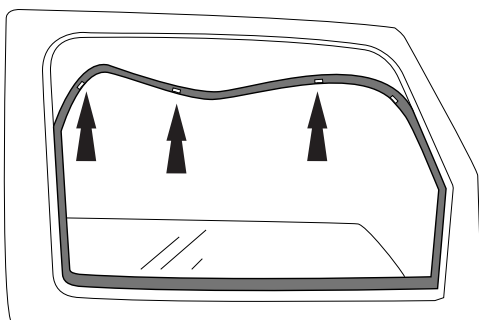

3

Réajustez le caoutchouc d'étanchéité avec le canal de la glace. **REMARQUE :** ne repositionnez PAS complètement le caoutchouc d'étanchéité tout de suite.

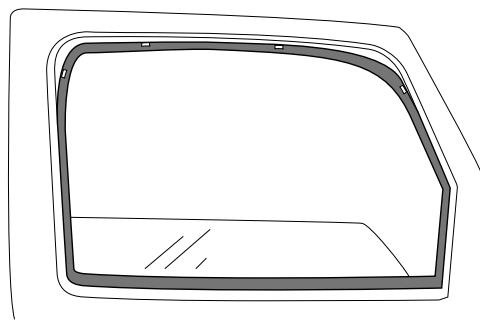

4



En commençant à l'avant, insérez le pare-soleil dans l'attache. À l'aide d'un couteau à mastic, enfoncez le pare-soleil, l'attache de retenue et le caoutchouc d'étanchéité dans le canal de la glace.

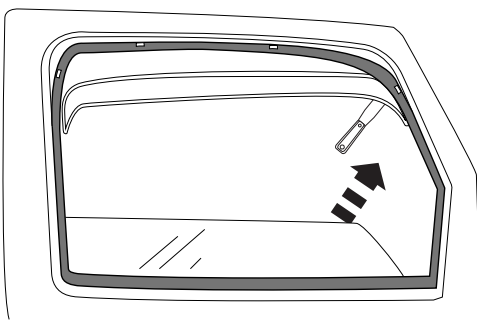

5

Répétez l'étape 5 aux endroits où il reste des attaches afin de finir l'installation du pare-soleil avant.

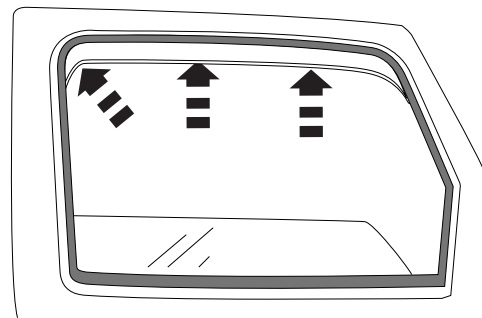

6

Installation sur la portière arrière



Répétez les étapes 1 à 6 aux trois (3) endroits indiqués ci-dessous. **REMARQUE :** la collerette arrière est insérée dans le canal de la glace du montant, et n'est pas maintenue par une attache de retenue.

Collerette arrière insérée dans le canal de la glace du montant

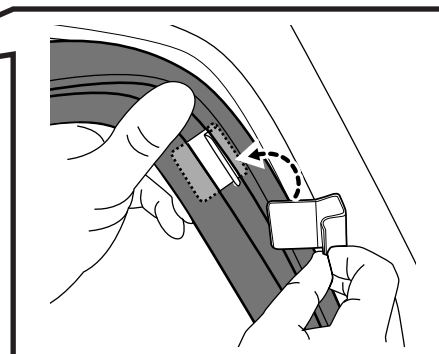
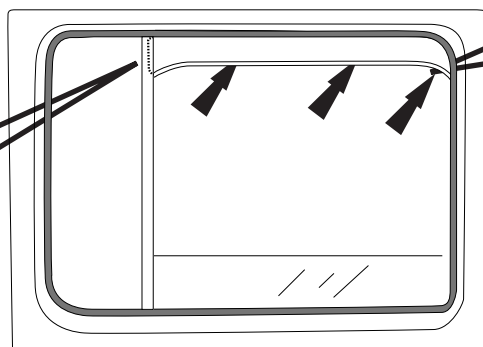
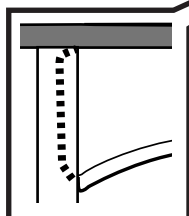

7

Étapes d'installation

REMARQUE : La méthode d'application peut être légèrement différente de celle représentée par les illustrations.

Au niveau de la collerette arrière indiquée ci-dessous, utilisez un couteau à mastic pour insérer une attache d'entretoise dans le canal de la glace afin de maintenir la collerette arrière en place.

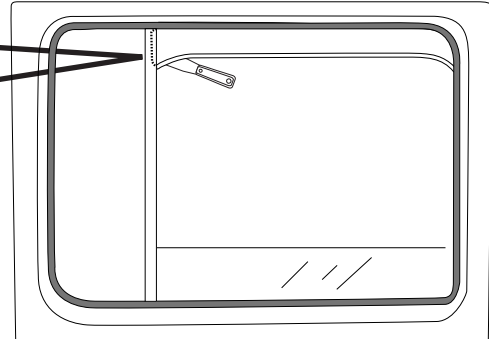
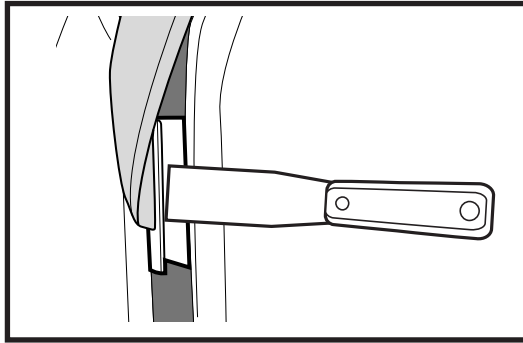

8

Répétez les **étapes 1-8** pour les autres glaces.

Entretien et nettoyage

- Laver exclusivement avec de l'eau savonneuse et sécher avec un chiffon propre.

Félicitations !

Vous avez acheté l'un des nombreux produits de qualité Lund™ fabriqués par Lund International, Inc. Nous sommes extrêmement fiers de nos produits et souhaitons que vous tiriez des années de satisfaction de votre investissement. Nous avons pris toutes les mesures nécessaires pour assurer que ce produit est d'une qualité supérieure en ce qui concerne l'ajustement, la durabilité, la finition et la facilité d'installation.



Lund International

800-328-2409 • Visitez notre site lundinternational.com

© 2015 Lund International, Inc. Tous droits réservés.

Lund® et le logo Lund® sont des marques déposées de Lund International, Inc.



Instrucciones de instalación

07-18 Jeep Wrangler JK



VS18RPG
Part Number
78918

Ventshade® Deflector

Para una instalación adecuada y el mejor ajuste posible, lea todas las instrucciones ANTES de comenzar. Si desea recibir asistencia técnica u obtener piezas faltantes, llame al Servicio al cliente al 1-800-328-2409.

Información importante de seguridad



- PRECAUCIÓN - Antes de conducir, asegúrese de que la visera esté correctamente anclada al vehículo.
- No utilice servicios automáticos de limpieza de vehículos que utilizan cepillos.
- No utilice limpiadores al solvente de ningún tipo.
- Compruebe periódicamente que todos los componentes estén ajustados.

Contenido: juego de 2 piezas

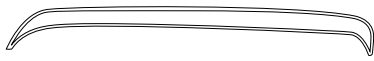

Visor delantero del lado del conductor



Visor delantero del lado del pasajero

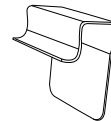

Sujetadores de retención x8

Contenido: juego de 4 piezas



Visor delantero del lado del conductor



Visor delantero del lado del pasajero

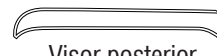

Visor posterior del lado del conductor



Visor posterior del lado del pasajero

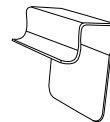

Sujetadores de retención x14

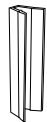

Sujetadores espaciadores x2

Herramientas necesarias



Equipo de limpieza de vehículos



Toalla limpia



Escariador

Preparación antes de pintar o instalar

- Se recomienda realizar un ajuste de prueba para garantizar el posicionamiento y ajuste correctos.
- Verifique el ajuste de las partes antes de pintarlas, no se aceptará la devolución de partes modificadas o pintadas.
- Lave y seque su vehículo para quitar cualquier desecho o suciedad del área de instalación.

Pasos de instalación **NOTA:** La aplicación real tal vez pueda variar un poco de las ilustraciones.

Ventana inferior del lado del pasajero. Sujete el burlete de goma de la ventana y retírelo del canal de la ventana.

canal de goma de la ventana

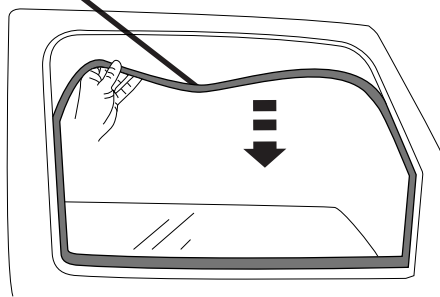

1

Pasos de instalación

AVISO: La colocación real puede variar con respecto a las ilustraciones.



Desde el lado delantero, inserte un sujetador de retención debajo del burlete. **NOTA:** El sujetador de retención se deslizará **dentro** del área con forma de bolsa ubicada debajo del burlete.

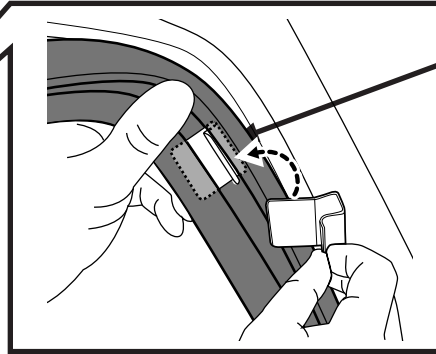
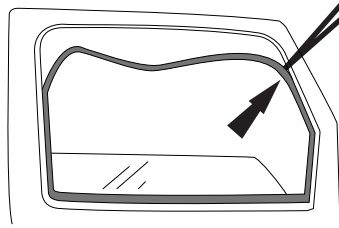

sujetador de retención correctamente colocado

2



Repita el **paso 2** e inserte tres (3) sujetadores de retención adicionales en el burlete.

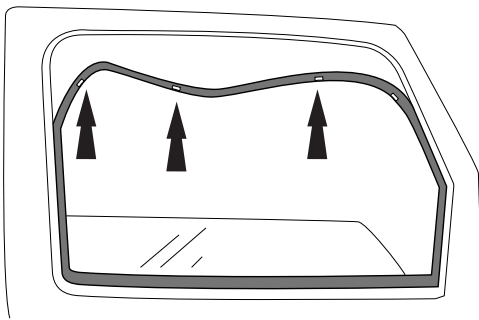

3

Alinee nuevamente el burlete con el canal de la ventana. **NOTA:** NO vuelva a insertar completamente el burlete en este momento.

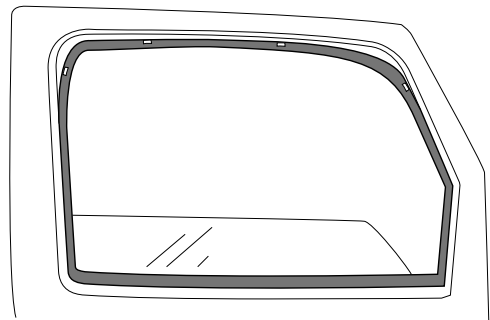

4



Desde el lado delantero, inserte el visor en el sujetador. Utilice un escariador para presionar el visor, el sujetador de retención y el burlete en el canal de la ventana.

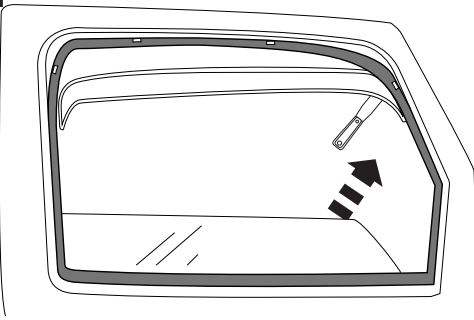

5

Repita el **paso 5** en las ubicaciones de los sujetadores de retención para finalizar la instalación del visor delantero.

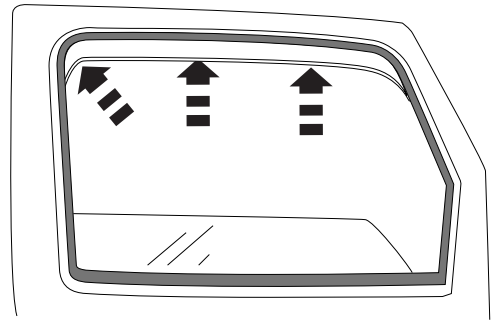

6

Instalación de la puerta posterior

Repita los **pasos 1 al 6** en las tres (3) ubicaciones indicadas a continuación. **NOTA:** La brida posterior se encuentra insertada en el canal posterior de la ventana y **no** requiere un sujetador de retención.



Viga posterior insertada en el canal posterior de la ventana

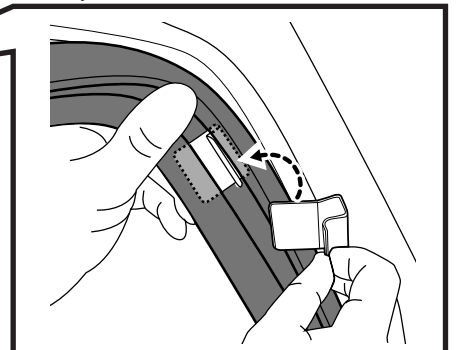
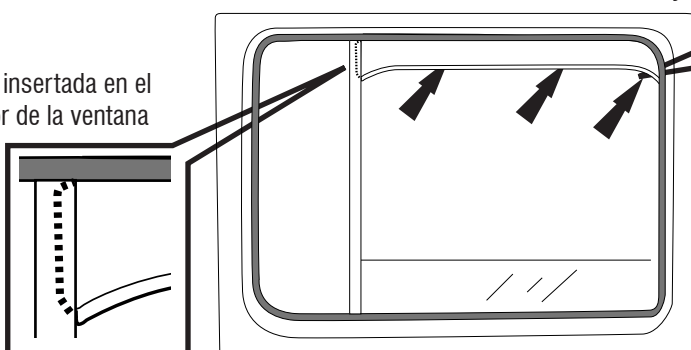

7

Pasos de instalación

AVISO: La colocación real puede variar con respecto a las ilustraciones.

En la ubicación de la brida posterior indicada a continuación, utilice un escariador para insertar un sujetador espaciador en el canal de la ventana para asegurar la brida posterior.



8

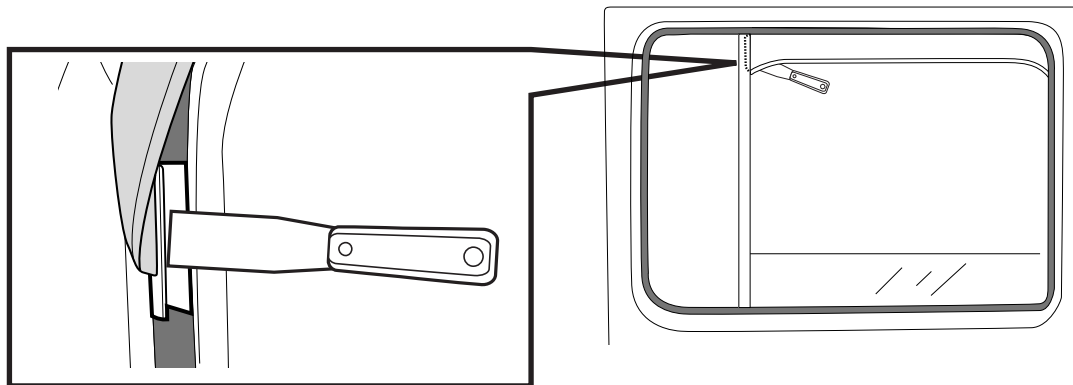

Repita los **pasos 1 al 8** para las ventanas restantes

Cuidado y limpieza

- Limpie solamente con agua jabonosa tibia y seque con un paño limpio.

Felicidades

Usted ha comprado uno de los tantos artículos de calidad de Lund™ ofrecidos por Lund International, Inc. Nuestros productos son nuestro mayor orgullo. Deseamos que disfrute de años de satisfacción con su inversión. Hemos realizado todos los esfuerzos para asegurarnos de que su producto sea de la mejor calidad en cuanto a ajuste, durabilidad, acabado y facilidad de instalación.



Lund International

800-328-2409 • Visite nuestro sitio Web: lundinternational.com ©

2015 Lund International, Inc. Todos los derechos reservados.

Lund® y el logo de Lund® son marcas registradas de Lund International, Inc.

