

ROUGH COUNTRY

SUSPENSION SYSTEMS®



1234BAG8

27.11
(688.7 mm)

99-06 2WD CHEVY/GM 1500 6" LIFT

Thank you for choosing Rough Country for all of your suspension needs.

Rough Country recommends a certified technician installs this system. In addition to these instructions, professional knowledge of disassemble/reassembly procedures as well as post installation checks must be known. Attempts to install this system without this knowledge and expertise may jeopardize the integrity and/or operating safety of the vehicle. Please read all the instructions before beginning the installation. Check the kit hardware against the Kit Contents list on next page. Be sure you have all the needed parts and understand where they go. Also please review the tools needed list to be certain that you have the tools necessary to complete the installation.

PRODUCT USE INFORMATION

▲WARNING

As a general rule, the taller a vehicle is the easier it will roll. We strongly recommend that seat belts and shoulder harnesses should be worn at all times. Braking performance and capabilities are decreased when significantly larger/heavier tires and wheels are used. Do not add, alter, or fabricate any factory or after-market parts which increase vehicle height over the intended height of the Rough Country product purchased. Rough Country makes no claims regarding lifting devices and excludes any and all implied claims. We will not be responsible for any product that is altered.

Due to differences in manufacturing, dimension and inflated measurements, tire and wheel combinations should be test fit prior to installation. This kit was developed using a 35.12.0-16 on stock wheel.

▲NOTICE

NOTICE TO DEALER AND VEHICLE OWNER

Any vehicle equipped with any Rough country product must have the "Warning to Driver" decal installed on the sun visor or dash. The decal is to act as a constant reminder for whoever is operating the vehicle of its unique handling characteristics. **INSTALLING DEALER**—It is your responsibility to install the warning decal and to forward these installation instructions on too the vehicle owner for review and to be kept in the vehicle for its service life.

Kit Contents:

1285:
1-Dr Side Knuckle
1-Pass Side Knuckle

1234BOX3:
Front Cross-member
Rear Cross-member
Fr Coil Spacers (2)

1234BOX5:
660766 Fr Shock (2)
660739 Rr Shock (2)
Fr Shock Bag (2)
Rear Fabbled Block(2)
Rear U-bolts
9/16" Nut U-bolt Bag
Fr Sway Bar Brkt (4)
Fr Sway Bar Link (2)
Sway Bar Link Bag
Coil Spacer Template



Bag Contents:

1234Bag2:
For Cross-Members
5/8" X 4 1/2" Bolt (2)
5/8" x 5 1/2" Bolt (2)
5/8" Lock Nut (4)

1234Bag7:
For Front Spacers:
3/8" Lock Nut (8)
1/2" Lock Nut (2)
1/2" Flat Washer (2)
1/2" x 1.5" Bolt (1)

LinkBag1:
For Fr Sway Bar Links
12MM X 65MM Bolts (4)
12mm X 35MM Bolts (4)
12MM Flange Nuts (8)



INSTALLATION INSTRUCTIONS

1. Set the emergency brake and chock rear tires to prevent rolling.
2. Jack up the front of the vehicle with a floor jack. Place jack stands on the frame rail directly behind the lower control arm mounts. Lower the vehicle onto the jack stands.
3. Remove the tires/wheels.
4. Remove the bolt on the top of the knuckle that secures the brake line to the knuckle using a 10mm wrench. **See Photo 1.**
5. Remove the ABS wire from the mounts on the control arm and from the clip on the upper coil seat. **See Photo 2.**

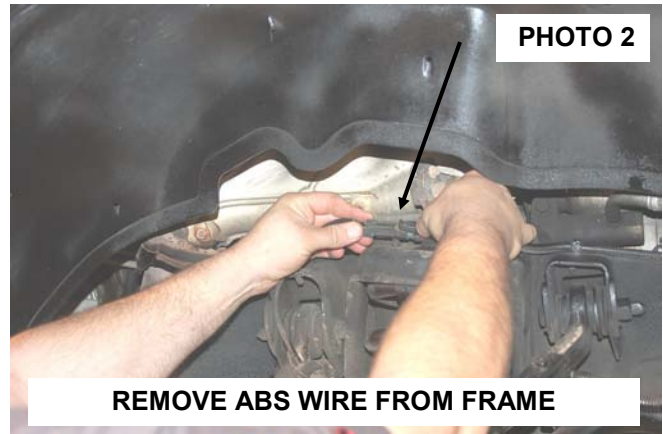
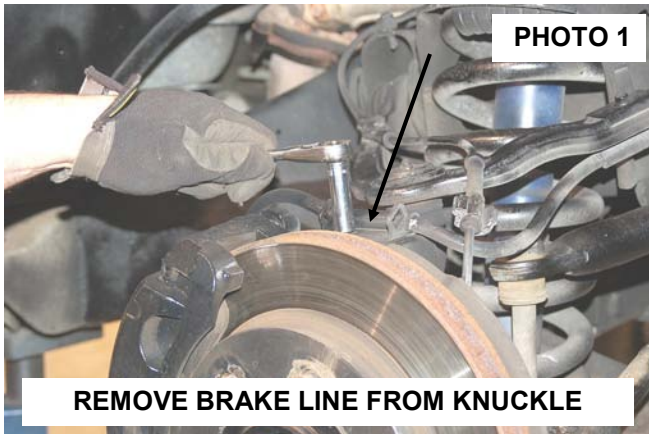

6. Remove the brake caliper using a 18mm socket and secure out of the way. **See Photo 3.** Remove the brake rotor and set aside.
7. Remove the tie rod end from the knuckle using a 18mm socket and secure out of the way. **See Photo 4.**

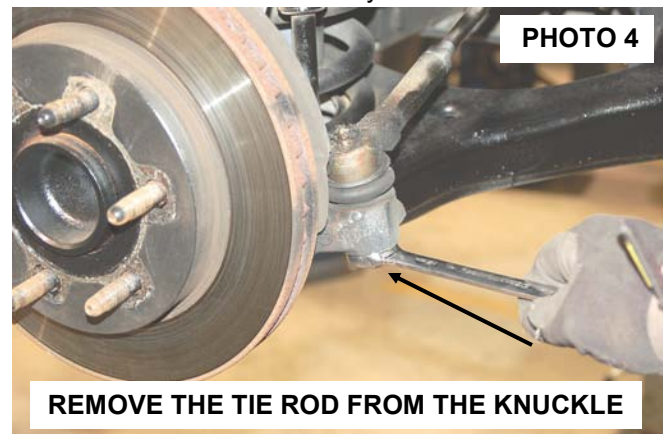

8. Loosen and remove the tie rod by striking the knuckle as shown to dislodge the tie rod. **See Photo 5.**
9. Place the floor jack directly underneath the lower control arm and loosen the upper ball-joint nut holding the upper control arm onto the knuckle using a 18mm wrench. **See Photo 6.**

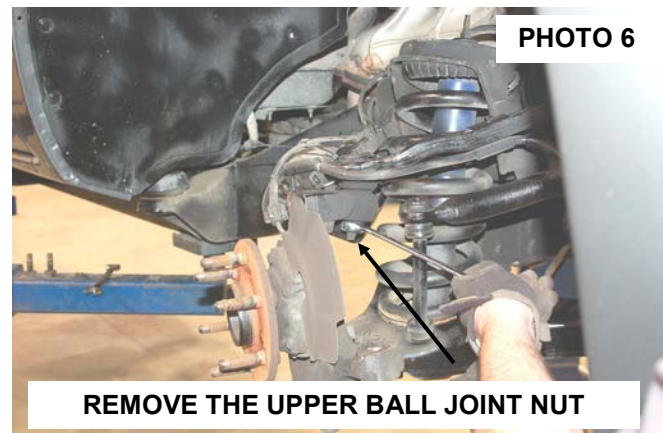
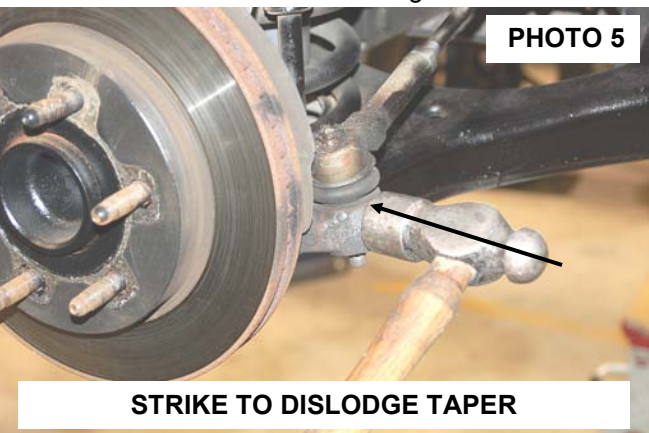

10. Remove the ball joint by either by using a ball joint separator tool or by striking on the upper portion of the knuckle until the upper ball joint is free. **See Photo 7.**
11. Loosen the lower ball joint nut using a 18mm wrench. **See Photo 8.** Do not remove the lower ball joint nut at this time.

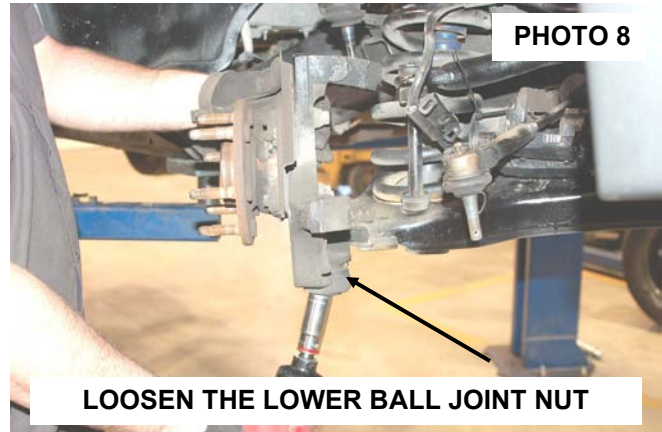
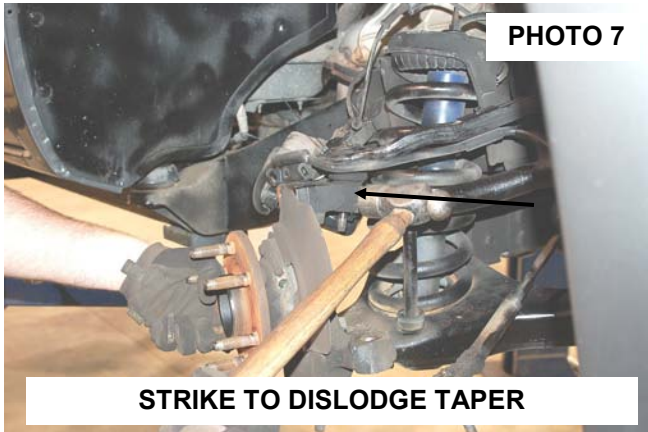

12. Remove the sway bar using a 15mm wrench. **See Photo 9.**
13. Strike to dislodge the lower ball joint as shown in **Photo 10** and remove the lower nut and remove the knuckle from the vehicle.

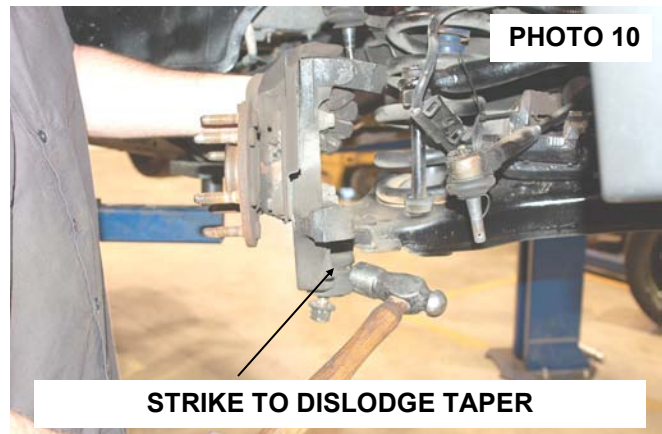
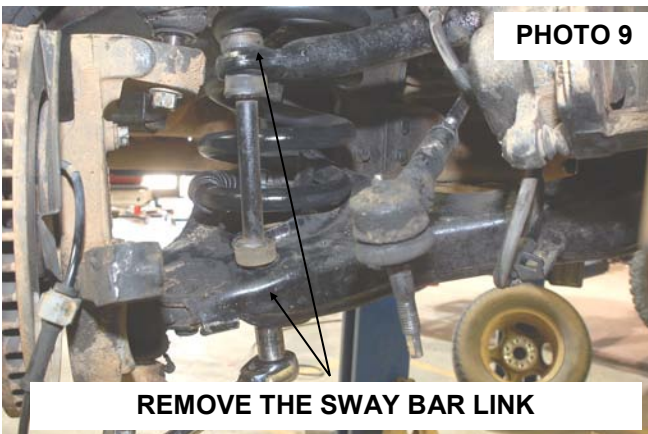

14. Remove the coil spring
15. Loosen the lower arm hardware using a 18mm socket & 24mm wrench and remove the lower arm. **See Photo 11.** Retain the hardware for reuse.
16. Remove the lower bump stop from the frame using a 15mm socket / wrench. **See Photo 12.** Retain the hardware for reuse.

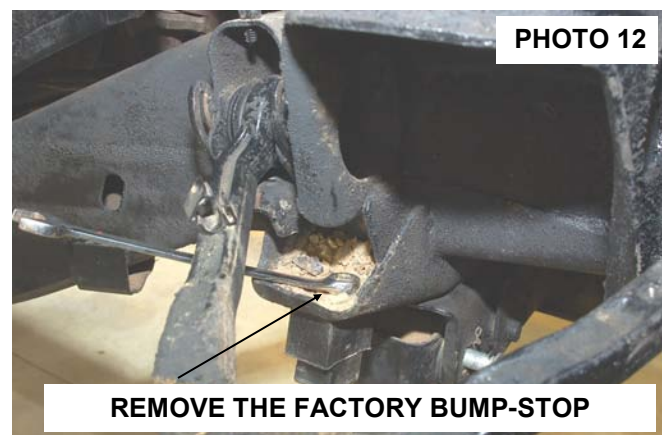
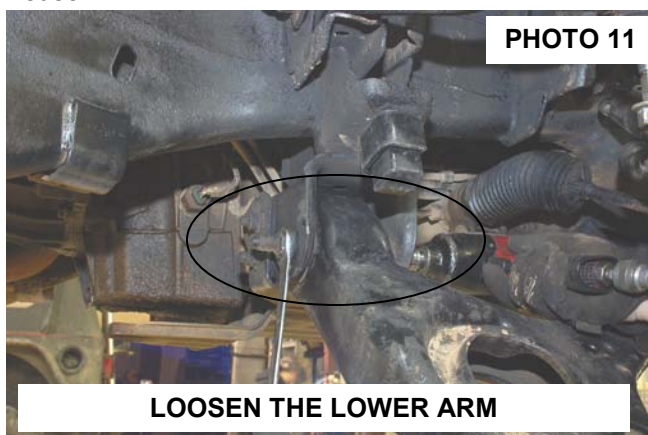

17. Remove the three bolts that secure the bearing assembly to the stock knuckle and remove using a 15mm socket. These bolts will be reused later in installation of new knuckles. **See Photo 13 & 14.**

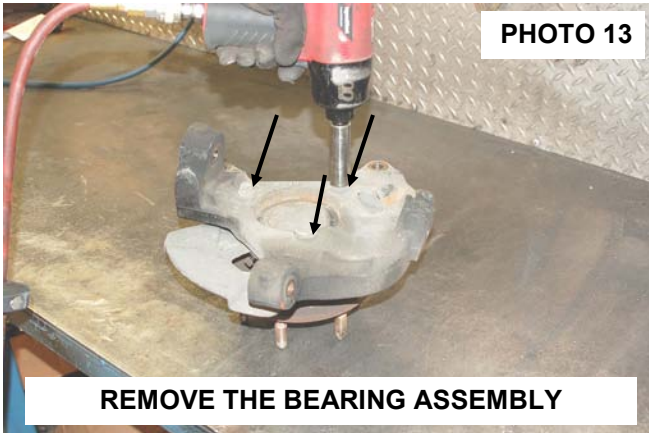

18. Install the bearing assembly on the new knuckle with the three factory bolts making sure to align the brake cover and tighten using a 15mm socket to factory specs. **See Photo 15.**

19. Remove the lower skid plate using a 15mm socket. **See Photo 16.**



20. Install the coil spacer template temporarily with the supplied 1/2" x 1.5" bolt and nut (1234BAG7) and drill the holes using a 13/32" drill bit. **See Photo 17 & 18.**

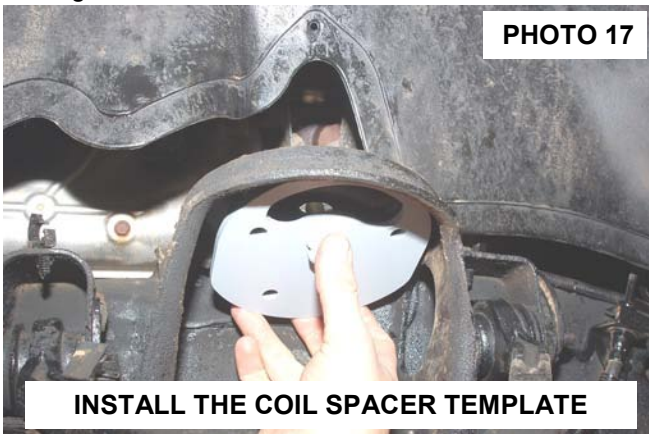

21. Remove the template and install the spring spacer using the supplied 3/8" lock nuts, 1/2" lock nuts and 1/2" flat washer. **See Photo 19.**
22. Reinstall the stock coil isolator on the coil spacer. **See Photo 20.**



23. Install the front cross-member with the stock hardware. **See Photo 21.** Do not tighten at this time.
24. Install the rear cross-member using the stock hardware. **See Photo 22.** Do not tighten at this time.



25. Install the stock bump-stop that was removed from the frame on the rear cross-member. Tighten using a 15mm wrench. **See Photo 23.**
26. Install the lower control arm on the new cross-members using the supplied 5/8" x 4 1/2" bolts & lock nuts for the front cross-member and the supplied 5/8" x 5 1/2" Bolts & lock nuts for the rear cross-member. Do not tighten at this time. **See Photo 24.**

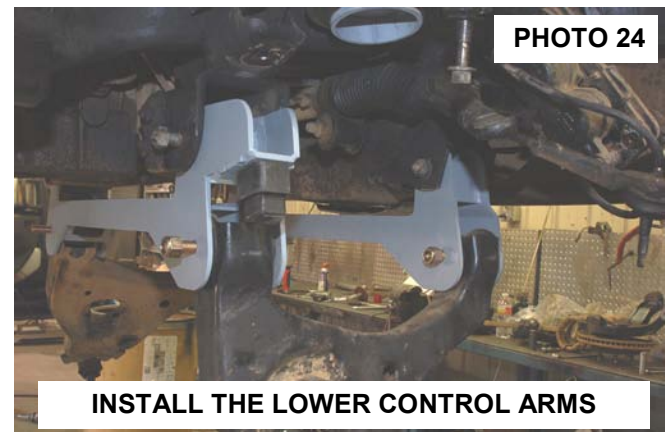

27. Position the coil on the upper coil spacer and swing up the arm making sure the coil spring seats in the lower control arm. **See Photo 25.** Support using a floor jack.
28. Install the knuckle on the lower ball joint with the stock hardware and tighten using a 24mm wrench. **See Photo 26.**

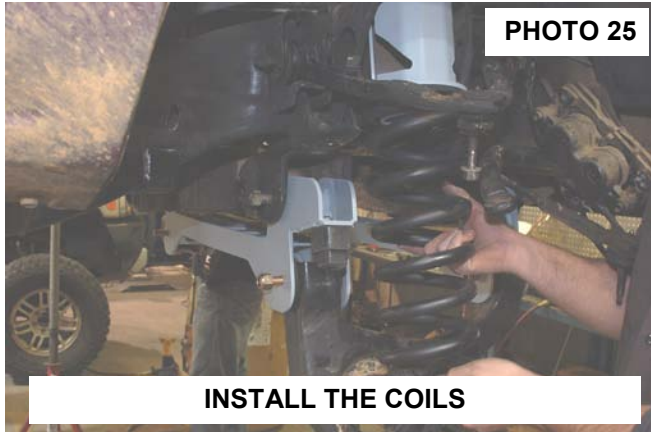

29. Jack up the lower arm, compressing the coil spring and attach the upper control arm to the knuckle with the stock hardware. Tighten using a 18mm socket. **See Photo 27.**
30. Install the bracket on the sway bar with the supplied 12mm x 35mm bolt and flange lock nut. The bolt will install from the bottom up. **See Photo 28.** Do not tighten at this time.

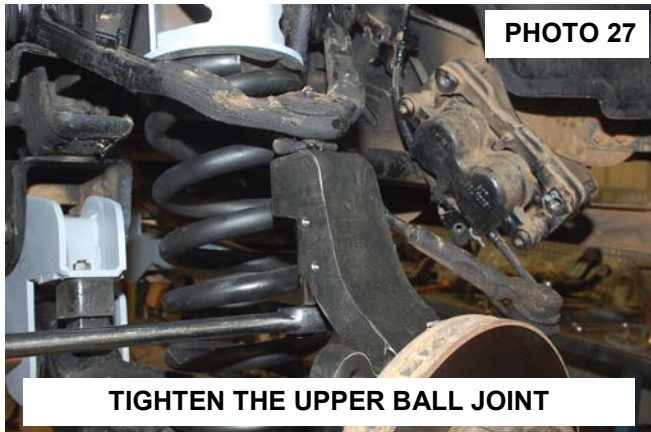

31. Install the bracket on the lower control arm as shown in **Photo 29** and secure with the supplied 12mm x 35mm bolt and flange lock nut.
32. Install the link and position upper and lower mounts. After they have been moved into position, remove the link and tighten the upper and lower mounts using a 18mm socket and wrench.
33. Re-install the link as shown in **Photo 30** and secure with the 12mm x 65mm bolts and flange lock nuts. Tighten using a 18mm socket and wrench.

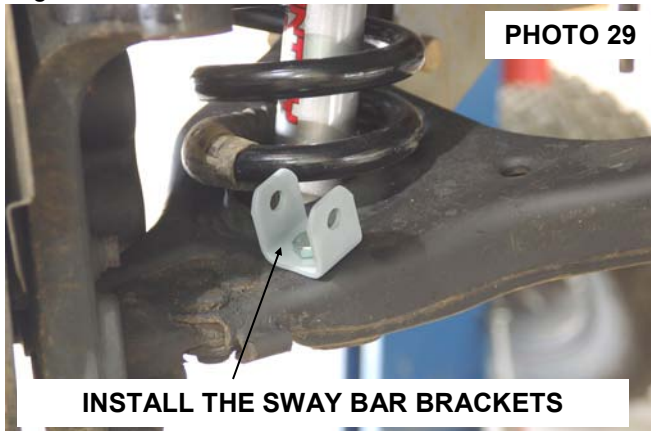

34. It may be necessary to reposition the brake line mounting bracket to allow the bracket to bolt up to the new mounting hole on the knuckle. If needed spray the control arm bracket and knuckle bracket with WD40 and slide the brackets to allow the brake line to install on the knuckle and upper control arm. Move the knuckle from full left turn and right turn to make sure the brackets are positioned correctly and the brake line is not pulled. **See Photo 31.**
35. Move brackets as needed and install the brake line bracket bolt onto the hole on side of the new knuckle and on the upper control arm with the stock hardware. **See Photo 32 & 33.** Tighten brake brackets using a 10mm wrench.



36. Reinstall the brake caliper and tighten using a 18mm socket to factory specs. **See Photo 34.**

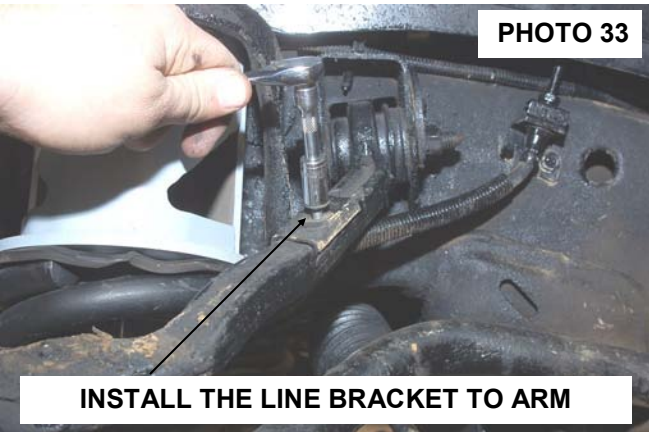

37. Install the tie rod end on the new knuckle. Tighten using a 18mm wrench to factory specs and install the cotter pin.
38. Bend the brake line bracket as shown to install the ABS wire as shown in **Photo 35.** If needed spray the line with WD40 and move the rubber mounts to install the wire on the arm and on the upper coil seat. Reinstall the ABS wire in the clip on the upper coil seat. **Be sure to check for adequate clearance and move as necessary.**
39. Install the new shock absorbers with the factory hardware on the lower control arm and with the supplied bushings on the upper stuff mount. **See Photo 36.** Tighten the upper stud until the bushings slightly bulge using a 9/16" wrench.
40. Recheck all fasteners and install the wheels/tire. Repeat process for opposite side.
41. Install the tires and wheels and lower the vehicle to the ground.
42. Tighten the lower control arms and cross-member hardware using a 24mm socket and wrench.

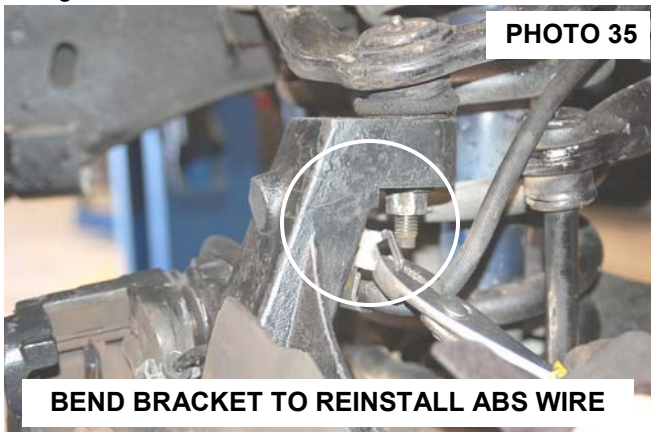

REAR INSTALLATION

1. Chock the front wheels and jack up the rear of the vehicle. Support the vehicle with jack stands. Remove the tires/wheels using 7/8" deep well socket.
2. Remove the factory shocks using a 21mm wrench and discard.
3. Support the rear axle with a floor jack and remove the factory u bolts.
4. Install the block on the axle and make sure the block and axle pin align. **See Photo 1.**
5. Install the supplied 7/16" u-bolts, washers, and nuts on the leaf springs, securing the block to the springs. Do not tighten at this time. **See Photo 2.**

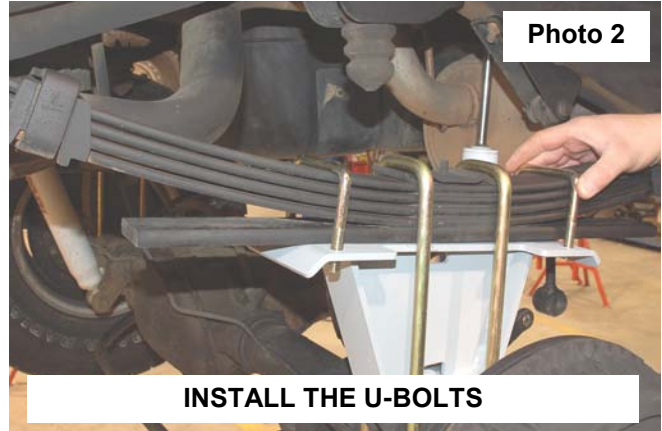

6. Grinding may be required on the driver side e-brake bracket on the lower shock mount. If needed grind the threads to make sure there is no interference with the shock absorber.
6. Install the new shocks with the factory bolts and nuts using a 21mm wrench. **See Photo 3.**
7. Install the wheels and tires. Tighten lug nut to factory specifications using crossing pattern. Lower the vehicle to the ground.
8. Tighten the lug nuts to 85 ft lbs.

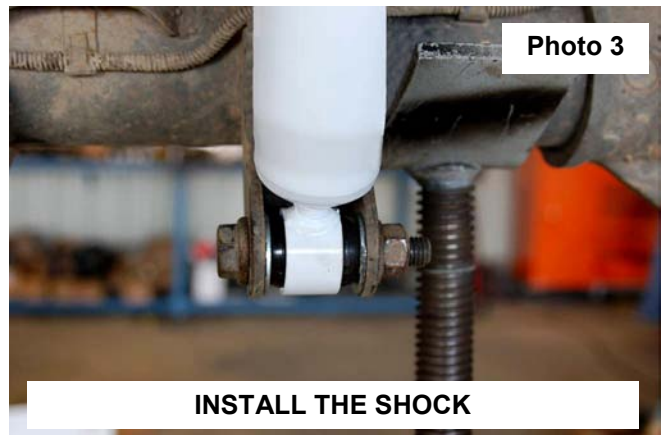

POST INSTALLATION INSTRUCTIONS

1. Check all fasteners for proper torque. Check to ensure for adequate clearance between all rotating, mobile, fixed, and heated members. Verify clearance between brake lines. Check steering gear for clearance. Test and inspect brake system.
2. On some vehicles the front lower skirting will need to be trimmed if using certain wheel /tire combinations and with heavy offset wheels. Trim only as needed.
3. Have a qualified alignment center align the vehicle immediately. Realign to factory specifications. Have headlights adjusted to proper settings.
6. Perform head light check and adjustment to proper settings.
7. Check and retighten wheels at 50 miles and again at 500 miles.
8. All kit components must be retightened at 500 miles and then every three thousand miles after installation. Periodically check all hardware for tightness.
9. Install "Warning to Driver" decal on sun visor.

Note: Installation of larger tires will require speedometer recalibration.

By purchasing any item sold by Rough Country, LLC, the buyer expressly warrants that he/she is in compliance with all applicable , State, and Local laws and regulations regarding the purchase, ownership, and use of the item. It shall be the buyers responsibility to comply with all Federal, State and Local laws governing the sales of any items listed, illustrated or sold. The buyer expressly agrees to indemnify and hold harmless Rough Country, LLC for all claims resulting directly or indirectly from the purchase, ownership, or use of the items.

